

Beta



C45



www.beta-tools.com

C45/D

Combination comprising:

- 1 fixed module with 7 drawers (C45M7)
- 1 mobile roller cab with 7 drawers (C45C7)
- 1 fixed service module (C45MS)
- 1 fixed module with 5 drawers (C45M5)
- 1 fixed module with 2 doors (C45MA)
- 5 perforated tool panels (C45PF)
- 5 wall-mounted cabinets (C45PM)
- 7 wall brackets, wide type (C45SL)
- 2 wall brackets, narrow type (C45SS)
- 2 single-door tool cabinets (C45AS1)

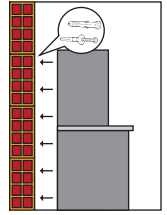

C45/DX

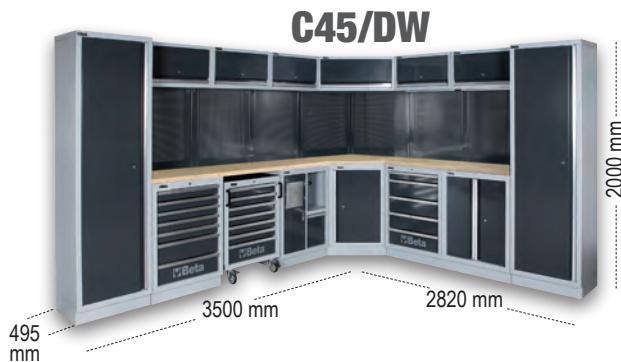

C45/DW

Workshop equipment combination C45/DX

- 1 worktop made of stainless steel coated MDF (C45PX/3-2,0MT)
- 1 worktop made of stainless steel coated MDF (C45PX/2-1,3MT)
- 1 self-supporting complete corner with stainless steel coated MDF worktop (C45CORNER/X)

Workshop equipment combination C45/DW

- 1 multi-ply wood worktop (C45PW/3-2,0MT)
- 1 multi-ply wood worktop (C45PW/2-1,3MT)
- 1 self-supporting complete corner with wood worktop (C45CORNER/W)

C45/DX

045000075 572 kg

C45/DW

045000076 568 kg

WORKSHOP EQUIPMENT COMBINATION C45

C45

Workshop equipment combination C45/X

- Worktop made of coated MDF stainless steel (C45PX/3-2.0MT)

C45/X

045000010 305 kg

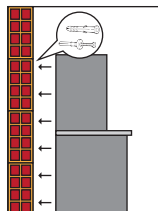

Workshop equipment combination C45/W

- Multi-ply wood worktop (C45PW/3-2.0MT)

C45/W

045000020 303 kg

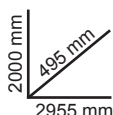

Combination comprising:

- Fixed module with 7 drawers (C45M7)
- Fixed service module (C45MS)
- Mobile roller cab with 7 drawers (C45C7)
- Two-door tool cabinet (C45AS2)
- 3 perforated tool panels (C45PF)
- 3 wall-mounted cupboards (C45PM)
- 3 wall brackets, wide type (C45SL)
- 1 wall bracket, narrow type (C45SS)



C45/A

Workshop equipment combination C45/AX

- Worktop made of coated MDF stainless steel (C45PX/3-2.0MT)

C45/AX

045000030 206 kg

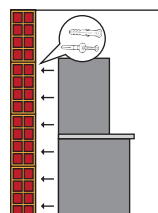

Combination comprising:

- Fixed module with 7 drawers (C45M7)
- Fixed service module (C45MS)
- Fixed two-door module (C45MA)
- 3 wall-mounted cabinets (C45PM)
- 3 perforated tool panels (C45PF)
- 2 wall brackets, wide type (C45SL)
- 2 wall brackets, narrow type (C45SS)

Workbenches for workshop equipment combination C45/AW

- Multi-ply wood worktop (C45PW/3-2.0MT)

C45/AW

045000040 204 kg

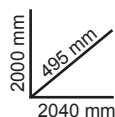

C45/B

Workshop equipment combination C45/BX

- Worktop made of coated MDF stainless steel (C45PX/2-1.3MT)

C45/BX

045000043 191 kg

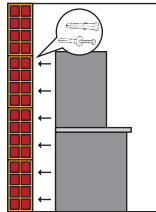

Combination comprising:

- Fixed module with 5 drawers (C45M5)
- Fixed two-door module (C45MA)
- Single-door tool cabinet (C45AS1)
- 2 wall-mounted cabinets (C45PM)
- 2 perforated tool panels (C45PF)
- 2 wall brackets, wide type (C45SL)
- 1 wall bracket, narrow type (C45SS)

Workshop equipment combination C45/BW

- Worktop made of coated MDF stainless steel (C45PX/2-1.3MT)

C45/BW

045000053 190 kg

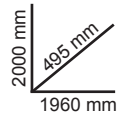

C45/C

Workshop equipment combination C45/CX

- Worktop made of coated MDF stainless steel (C45PX/2-1.3MT)

C45/CX

045000063 199 kg

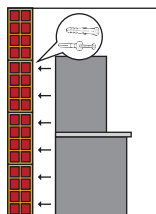

Combination comprising:

- Fixed module with 7 drawers (C45M7)
- Fixed service module (C45MS)
- Single-door tool cabinet (C45AS1)
- 2 wall-mounted cabinets (C45PM)
- 2 perforated tool panels (C45PF)
- 2 wall brackets, wide type (C45SL)
- 1 wall bracket, narrow type (C45SS)

Workshop equipment combination C45/CW

- Multi-ply wood worktop (C45PW/2-1.3MT)

C45/CW

045000073 198 kg

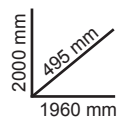

WORKSHOP EQUIPMENT COMBINATION C45

C45/E

Combination comprising:

- 2 perforated tool panels (C45PF)
- 2 wall-mounted cabinets (C45PM)
- 2 wall brackets, wide type (C45SL)
- 1 wall bracket, narrow type (C45SS)
- 1 single-door tool cabinet (C45AS1)

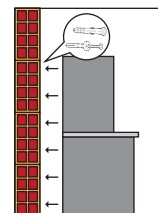

Workshop equipment combination C45/EX

- Fixed module with 7 drawers and worktop made of stainless steel coated MDF (C45M7A/X):
- 1 drawer 1248x406 mm
- 6 drawers 782x406 mm
- 5 drawers 85 mm high, 1 drawer 155 mm high
- 1 object compartment with intermediate shelf and door

C45/EX

045000078 174 kg

2000 mm
495 mm
1960 mm



Workshop equipment combination C45/EW

- Fixed module with 7 drawers and multi-ply wood worktop (C45M7A/W):
- 1 drawer 1248x406 mm
- 6 drawers 782x406 mm
- 5 drawers 85 mm high, 1 drawer 155 mm high
- 1 object compartment with intermediate shelf and door

C45/EW

045000079 173 kg

2000 mm
495 mm
1960 mm



C45/BP-1,3

- **Workbenches for workshop equipment combination C45/BPX-1,3**
 - Worktop made of coated MDF stainless steel (C45PX/2-1.3MT)

C45/BPX-1,3

045000083 140 kg

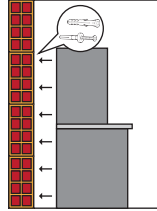

Combination comprising:

- Fixed module with 7 drawers (C45M7)
- Fixed module with 5 drawers (C45M5)
- 1 wall bracket, wide type (C45SL)
- 2 wall brackets, narrow type (C45SS)
- 2 perforated tool panels (C45PF)

- **Workbenches for workshop equipment combination C45/BPW-1,3**
 - Multi-ply wood worktop (C45PW/2-1.3MT)

C45/BPW-1,3

045000093 139 kg

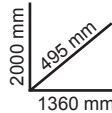

C45/BP-2,0

- **Workbenches for workshop equipment combination C45/AX**
 - Worktop made of coated MDF stainless steel (C45PX/3-2.0MT)

C45/BPX-2,0

045000090 158 kg

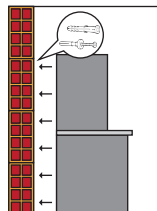

Combination comprising:

- Fixed module with 7 drawers (C45M7)
- Fixed module with 5 drawers (C45M5)
- 3 perforated tool panels (C45PF)
- 2 wall brackets, wide type (C45SL)
- 2 wall brackets, narrow type (C45SS)

- **Workbenches for workshop equipment combination C45/BPW-2,0**
 - Multi-ply wood worktop (C45PW/3-2.0MT)

C45/BPW-2,0

045000100 156 kg

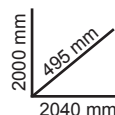

MODULES AND ACCESSORIES FOR WORKSHOP EQUIPMENT C45

C45M7A/X

● Fixed module with 7 drawers, for workshop equipment

- Worktop (1360 mm) made of stainless steel coated MDF
- Drawer bases protected by foamed rubber mats
- Front centralized lock
- Can be fitted with foam trays
- 1 compartment with intermediate shelf and door, interior dimensions 504x424x597 mm

Combination comprising:

- 1 drawer (1248x406 mm), with ball bearing slides

- 6 drawers (782x406 mm), with wall bearing slides:
 - 5 drawers 85 mm high
 - 1 drawer 155 mm high

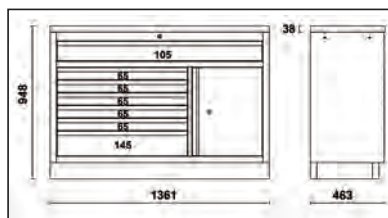

C45M7A/X

045000160 81 kg

h	max
65 mm	25 kg
105 mm	40 kg
145 mm	30 kg

C45M7A/W

● Fixed module with 7 drawers, for workshop equipment

- Multi-ply wood worktop (1360 mm)
- Drawer bases protected by foamed rubber mats
- Front centralized lock
- Can be fitted with foam trays
- 1 compartment with intermediate shelf and door, interior dimensions 504x424x597 mm

Combination comprising:

- 1 drawer (1248x406 mm), with ball bearing slides

- 6 drawers (782x406 mm), with ball bearing slides:
 - 5 drawers 85 mm high
 - 1 drawer 155 mm high

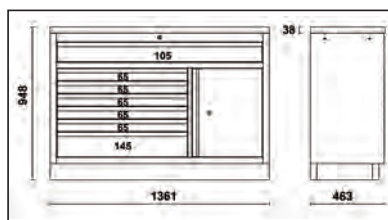

C45M7A/W

045000170 80 kg

h	max
65 mm	25 kg
105 mm	40 kg
145 mm	30 kg

C45PX

- 1.3-m-long worktop made of coated MDF stainless steel, for workshop equipment
thickness: 38 mm



≡ 1360x463x38 mm

C45PX/2-1,3MT

045000103 21 kg

≡ 2040x463x38 mm

C45PX/3-2MT

045000110 31,8 kg

C45PW

- 1.3-m-long wood worktop for workshop equipment
workbench thickness: 38 mm



≡ 1360x463x38 mm

C45PW/2-1,3MT

045000113 20 kg

≡ 2040x463x38 mm

C45PW/3-2MT

045000120 30 kg

C45MA

- Fixed two-door module for workshop equipment

- With lock
- Interior shelf, vertically adjustable
- Interior dimensions: 670x420 mm
- Misure interne 670x420 mm

≡ 680x458x910 mm

C45MA

045000212 29,4 kg



C45MS

- Fixed service module for workshop equipment

- Built-in waste bin
- Perforated paper roll compartment

≡ 680x458x910 mm

C45MS

045000219 37 kg



C45C7

- Mobile roller cab with 7 drawers, for workshop equipment

- 7 drawers (532x406 mm) with ball bearing slides
- 4 steering castors Ø 100 mm (1 with brake)
- Drawer bases protected by foamed rubber mats

C45C7

045000207 50 kg

h	max
65 mm	25 kg
145 mm	30 kg

≡ 646x458x862 mm



MODULES AND ACCESSORIES FOR WORKSHOP EQUIPMENT C45

C45M5

● Fixed module with 5 drawers, for workshop equipment

- 5 drawers (566x406 mm) with ball bearing slides
- Drawer bases protected by foamed rubber mats
- Front centralized lock
- Can be fitted with foam trays

h	max
65 mm	25 kg
145 mm	30 kg

680x458x910 mm

C45M5

045000215 49,3 kg



C45M7

● Fixed module with 7 drawers, for workshop equipment

- 7 drawers (566x406 mm) with ball bearing slides
- Drawer bases protected by foamed rubber mats
- Front centralized lock
- Can be fitted with foam trays

h	max
65 mm	25 kg
145 mm	30 kg

680x458x910 mm

C45M7

045000217 54,3 kg



C45PM

● Wall-mounted suspended cabinet for workshop equipment

680x281x350 mm fitted with gas springs, making it easier to open and close door



C45PM

045000301 10 kg

680x281x350 mm

C45SS

● Side wall brackets, narrow type, for item C45

NARROW TYPE

C45SS

045000332 1,5 kg

1420x32,5x30 mm

C45PF

● Perforated tool panel for workshop equipment

1052x614,5x24 mm

C45PF

045000311 5,3 kg



C45SL

● Side wall brackets, wide type, for item C45

WIDE TYPE

1420x65x30 mm

C45SL

045000365 2 kg



C45CORNER/X

- **Self-supporting complete corner**
 - Suspended corner cabinet with gas springs, making it easier to open and close door
 - Two perforated tool panels (1050x860 mm)
 - Stainless steel corner worktop (860 x 860 mm)
 - Lower corner module with large storage compartment



C45CORNER/X

045000400 94 kg

C45CORNER/W

- **Self-supporting complete corner**
 - Suspended corner cabinet with gas springs, making it easier to open and close door
 - Two perforated tool panels (1050x860 mm)
 - Multi-ply wood corner worktop (860 x 860 mm)
 - Lower corner module with large storage compartment



C45CORNER/W

045000410 93 kg

MODULES AND ACCESSORIES FOR WORKSHOP EQUIPMENT C45

C45AS1

- Sheet metal single-door tool cabinet for workshop equipment combination, with one wide bracket
 - 4 removable, vertically adjustable shelves
 - With lock
 - Interior dimensions: 590x430 mm



600x458x2000 mm

C45AS1

045000450 57,5 kg

C45AS2

- Sheet metal two-door tool cabinet for workshop equipment combination, with one wide bracket
 - 4 removable, vertically adjustable shelves
 - With lock
 - Interior dimensions: 910x430 mm



915x458x2000 mm

C45AS2

045000480 80 kg

C45A1/R600

- Interior shelf for tool cabinet C45AS1
 - 590x430 mm

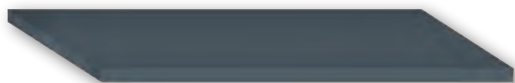

C45A1/R600

045000461 3,1 kg

C45A2/R915

- Interior shelf for tool cabinet C45AS2
 - 910x430 mm

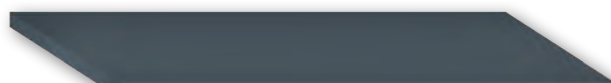

C45A2/R915

045000491 4,5 kg

5945VUM

● Assortment of 231 tools in EVA foam trays



MM11



MM61



MM105



MM140



MM210

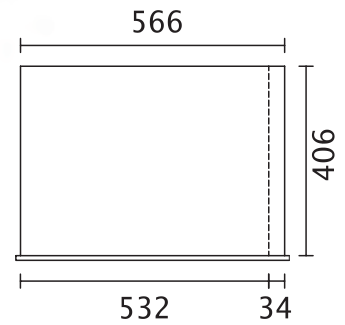

Quantity/Description

- 21 combination wrenches 6-7-8-9-10-11-12-13-14-15-16-17-18-19-20-21-22-24-27-30-32 mm
- 8 offset hexagon key wrenches \odot 2-2,5-3-4-5-6-7-8 mm
- 5 drivers for Torx® head screws, with handles \odot T10-T15-T20-T25-T30
- 1 engineer's hammer 300 g
- 1 soft face hammer \varnothing 35
- 2 flat chisels, ribbed type 100-200 mm
- 5 second cut files 200 mm
- 9 ball head offset hexagon key wrenches \odot 1,5-2-2,5-3-4-5-6-8-10 mm
- 1 socket holder \odot 1/4 - \square 1/4
- 1 socket holder \odot 1/4 - \square 3/8
- 1 socket holder \odot 5/16 - \square 1/2
- 13 1/4" hexagon sockets \odot 4-4,5-5-5,5-6-7-8-9-10-11-12-13-14 mm
- 9 hexagon hand sockets, long series \odot 5-6-7-8-9-10-11-12-13 mm
- 5 1/4" socket drivers for hexagon screws \odot 3-4-5-6-7 mm
- 4 socket drivers for slotted head screws \bullet 0,8x4-1x5,5x1,2x6,5-1,2x8 mm
- 4 socket drivers for cross head Phillips® screws \oplus PH1-PH2-PH3-PH4
- 7 socket drivers for Torx® head screws \odot T10-T15-T20-T25-T27-T30-T40
- 1 adaptor, 1/4" female and 3/8" male drives \square 1/4 - \blacksquare 3/8
- 1 1/4" drive extension bar 50 mm
- 1 1/4" drive extension bar 100 mm
- 1 1/4" drive extension bar 150 mm
- 1 1/4" drive universal joint
- 1 1/4" drive spinner handle 176 mm
- 1 1/4" drive swivel T-handle 115 mm
- 1 1/4" reversible ratchet \oplus 125 mm
- 17 hexagon hand sockets 3/8" \odot 6-7-8-9-10-11-12-13-14-15-16-17-18-19-20-21-22 mm
- 1 adaptor, 3/8" female and 1/4" male drives \square 3/8 - \blacksquare 1/4
- 1 adaptor, 1/2" female and 3/8" male drives \square 3/8 - \blacksquare 1/2
- 1 extension bar - 3/8" 125 mm
- 1 extension bar - 3/8" 250

Beta N. TR

- 42NEW MM11
- 96T MM61
- 97TTX MM140
- 1370 MM61
- 1390 MM61
- 35 MM61
- 1719BMA8/S5 MM61
- 96BPC/SC9 MM10
- 895/1 MM105
- 895/3 MM105
- 895/6 MM105
- 900 MM105
- 900L MM105
- 900ME MM105
- 900LP MM105
- 900PH MM105
- 900TX MM105
- 900/16 MM105
- 900/20 MM105
- 900/20L MM105
- 900/21 MM105
- 900/25 MM105
- 900BG/30 MM105
- 900/42 MM105
- 900/55 MM105
- 910A MM105
- 910/15 MM105
- 910/16 MM105
- 910/21 MM105
- 910/22 MM105

Quantity/Description

- 1 3/8" drive universal joint
- 1 3/8" drive sliding T - handle 210 mm
- 1 3/8" drive reversible ratchet \oplus 200 mm
- 21 1/2" square drive hexagon sockets \odot 8-10-11-12-13-14-15-16-17-18-19-20-21-22-23-24-26-27-28-30-32 mm
- 1 adaptor, 1/2" female and 3/8" male drives \square 1/2 - \blacksquare 3/8
- 1 1/2" drive universal joint
- 1 1/2" wobble extension bar 125 mm
- 1 1/2" wobble extension bar 250 mm
- 1 1/2" drive sliding T-handle 305 mm
- 1 1/2" drive reversible ratchet \oplus 275 mm
- 3 3/8" square drive spark plug sockets \odot 16 mm (5/8")-17,8 (11/16")-20,8 (13/16")
- 1 Heavy-duty diagonal cutting nippers \angle 160 mm
- 1 half-round needle nose pliers \equiv 180 mm
- 1 Extra-long needle nose pliers \bullet 160 mm
- 1 circlip pliers straight, internal \odot 19+60 mm
- 1 circlip pliers bent, internal \odot 19+60 mm
- 1 circlip pliers straight, external \bullet 19+60 mm
- 1 circlip pliers bent, external \bullet 19+60 mm
- 1 Slip joint pliers boxed joints 250 mm
- 1 self - locking pliers 240 mm
- 38 microscrewdriver with 36 interchangeable 4-mm bits and magnetic extension
- 6 screwdriver for slotted head screws \bullet 0,4x2,5x50-0,5x3x75-0,8x4x100-1,0x5,5x125-1,2x6,5x150-1,2x8x200 mm
- 1 screwdriver for slotted head screws, extra-short series \bullet 0,8x4x30 mm
- 4 screwdriver for cross head Phillips® screws \oplus PH0x60-PH1x80PH2x100PH3x150 mm
- 1 screwdriver for cross head Phillips® screws, extra-short series \oplus PH1x30 mm
- 12 screwdrivers for Torx® head screws, with handles \odot T06-T07-T08-T09-T10-T15-T20-T25-T27-T30-T40-T45
- 1 mains testing screwdriver \bullet 0,5x3,5x100 mm
- 910/25 MM105
- 910/42 MM105
- 910/55 MM105
- 920A MM105
- 920/15 MM105
- 920/25 MM105
- 920AN MM105
- 920AN MM105
- 920/42 MM105
- 920/55 MM105
- 956E MM105
- 1084BM MM140
- 1150BM MM140
- 1166BM MM140
- 1032 MM140
- 1034 MM140
- 1036 MM140
- 1038 MM140
- 1048 MM140
- 1052 MM140
- 1256/C36-2 MM140
- 1201E MM210
- 1201EN MM210
- 1202E MM210
- 1202EN MM210
- 1207E/TX MM210
- 1253 MM210

5945VUM

059451001 19,6 kg

5958U

● Assortment of 85 tools



Quantity/Description

- 17 combination wrenches 6+22 mm
- 12 offset hexagon key wrenches \varnothing 2+10 mm
- 13 1/2" square drive hexagon sockets with rail \varnothing 10+22 mm
- 8 1/2" square drive hexagon sockets with rail \varnothing 23+32 mm
- 1 1/2" drive extension bar 125 mm
- 1 1/2" drive extension bar 255 mm
- 1 1/2" drive universal joint
- 1 1/2" drive sliding T-handle
- 1 1/2" drive reversible ratchet
- 1 circlip pliers straight, internal \varnothing 180 mm
- 1 circlip pliers straight, external \bullet 175 mm

Beta N.

- 42NEW
- 96N/SC12
- 920A/SB13
- 920A/SB8
- 920/21
- 920/22
- 920/25
- 920/42
- 920/55
- 1032
- 1036

Quantity/Description

- 1 Slip joint pliers boxed joints 250 mm
- 1 self - locking pliers 240 mm
- 1 Heavy-duty diagonal cutting nippers ∇ 160 mm
- 1 electrician's scissors, straight blades
- 1 half-round needle nose pliers \equiv 180 mm
- 1 Extra-long needle nose pliers \equiv 160 mm
- 7 screwdrivers for cross head Phillips® screws \bullet 3x75 - 3,5x100 - 4x125
- 5,5x150 - 6,5x150 - 8x200 - 10x200 mm
- 4 screwdrivers for cross head Phillips® screws \oplus PH0x60 - PH1x80
- PH2x100 - PH3x150 mm
- 1 engineer's hammer 300 g
- 1 soft face hammer \varnothing 35 mm
- 1 measuring tape 5 m
- 5 Set of 5 second-cut files, with handles 200 mm
- 1 hacksaw frame, aluminium handle
- 1 plastic oil can 150 cc
- 1 snap - off blade utility knife

Beta N.

- 1048
- 1052
- 1084BM
- 1128BMX
- 1150BM
- 1166BM
- 1260
- 1262/S4
- 1370
- 1390
- 1692
- 1719BMA/S5
- 1725
- 1754
- 1771

5958U

059581008 11,3 kg

C45LMP

- LED lamp for workshop equipment C45 - RSC55
 - Length: 630 mm
 - Easy to fix under wall cabinet through adhesives
 - ON/OFF switch
 - 570 lumens



C45LMP

045000320 307 g

Input: 100-240V 0,6A
Output: 12V 1.50A 18.0W

CP

- Wall-mounted bottle holder rack, made of steel
 - Can be used with wall-mounted tool panels



CP

088880470 522 g

280x115x95 mm

PM/6C

- 6-tray tool holder, made of plastic, with support
 - Interior dimensions of tray: 80x60 mm
 - Can be used with tool wall systems C45 and RSC55

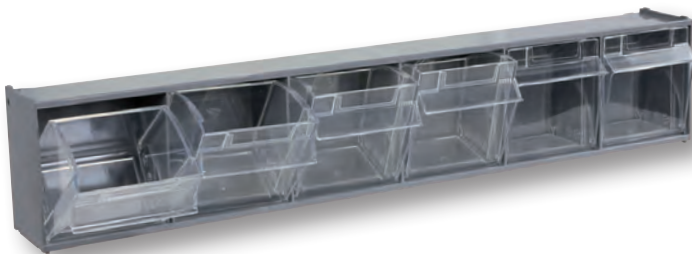

PM/6C

088880440 970 g

600x115x95 mm

PM/5C

- 5-tray tool holder, made of plastic, with support
 - Interior dimensions of tray: 95x120 mm
 - Can be used with tool wall systems C45 and RSC55



PM/5C

088880450 1,8 kg

600x165x140 mm

ACCESSORIES AND TOOL HOOKS FOR PERFORATED PANELS

KIT/GPS

088880119

Kit of 40-mm GPS hooks with screws VE1

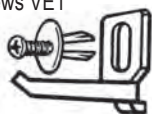

GM

Snap hooks with screw



	∅
088880250	6,5
088880251	9,5
088880252	13
088880253	16
088880254	19
088880255	25

S55/8

088880420

Supports for double open end wrenches

55/S8
55AS/8
55MP/S8

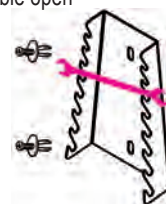

S55/12

088880421

Supports for double open end wrenches

55/S12
55/S12X
55AS/12
55MP/S12

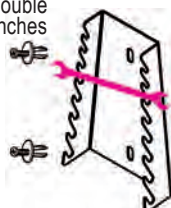

ST2P

088880422

Pliers pocket

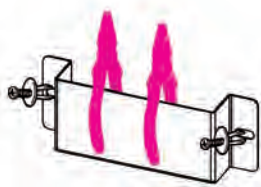

TSPP

088880402

Tool pockets

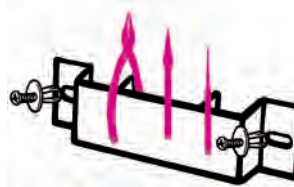

S952/10

088880423

Supports for T-handle wrenches with swivelling socket

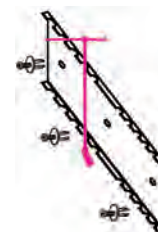

S1719BM

088880404

Supports for files



1719BMA: Q-T-P-M-R
1719BMD: Q-T-P-M-R

SGN

088880405

Supports for mini screwdrivers

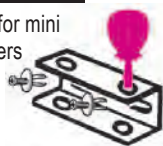

1290N-1292N-1299N/PZ
1260N-1262N-1269N/PZ
1201N-1202N-1209N/PZ

S42/17

088880428

Supports for combination wrenches

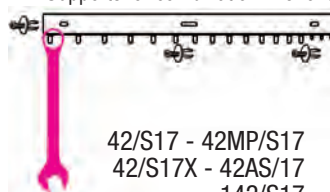

42/S17 - 42MP/S17
42/S17X - 42AS/17
142/S17

S951/6

088880429

Supports for T handle wrenches with hexagon male ends

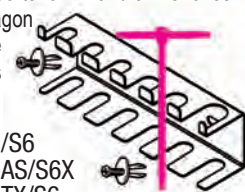

951/S6
951AS/S6X
951TX/S6

SPG11

088880910

Supports for screwdrivers

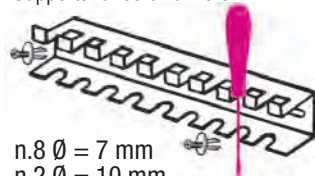

n.8 ∅ = 7 mm
n.2 ∅ = 10 mm
n.1 ∅ = 12 mm

S1203/8

088880430

Supports for screwdrivers

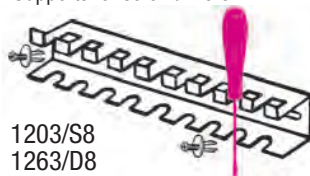

1203/S8
1263/D8
1293/S8

S96T/8

088880431

Supports for hexagon key wrenches

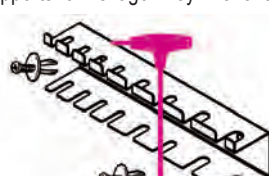

96T/SPV

000960958

Supports for items 96T and 97TTX

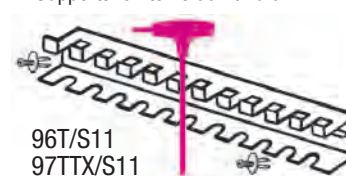

96T/S11
97TTX/S11

998011156



8 054809 207421

MODULARITY
ORGANIZATION
DESIGN
QUALITY
MODULARITY
DESIGN
MODULARITY
ORGANIZATION
QUALITY
MODULARITY

cunha  mendes cunha, lda
Equipamentos Industriais

email:cmc@cmc.pt

web:www.cmc.pt

www.cmc.pt