

LEISTER

PLASTIC WELDING

Swiss
made 



General Catalog

Plastic Welding

The only choice for professionals



www.cmc.pt

We know how.



Leister AG, Headquarters, Kaegiswil, Switzerland



Leister Technologies AG, factory, Samen, Switzerland



Axetris AG, Kaegiswil, Switzerland



Leister Technologies Ltd.,
Shanghai, China



Leister Technologies GmbH,
Hagen, Germany



Leister Technologies Benelux BV,
Houten, Holland



Leister Technologies Italia S.r.l.,
Milan, Italy



Leister Technologies LLC,
Itasca, USA



Leister Technologies KK,
Yokohama, Japan



Leister Technologies India Pvt,
Chennai, India

Leister delivers performance.

For 70 years, Leister has been the worldwide leader in the field of plastic welding and industrial hot-air applications. In addition we also offer innovative and effective lasersystems and microsystems. Leister is proud to develop and produce all products in Switzerland – so you can always rely on the proverbial Swiss made quality.

Over 98 percent of our products are exported. With an established network of 130 sales and service centers all over the globe, you will find a Leister partner guaranteed. We are local worldwide.





LEISTER

PLASTIC WELDING

For decades now, Leister has been the worldwide market leader. The performance and reliability of our products makes Leister the first choice. Our tools are used in roofing, billboards, tarpaulins, civil engineering, tunneling, landfills, flooring, plastic fabrication, and shrinking to name a few.



LEISTER

PROCESS HEAT

Hot-air is increasingly deployed in industrial processes. Typical applications include activating, heating, curing, melting, shrinking, welding, sterilizing, drying and warming to name a few. Leister customers profit from our extensive engineering knowledge and benefit from our recommendations during the conceptual design of hot-air applications.

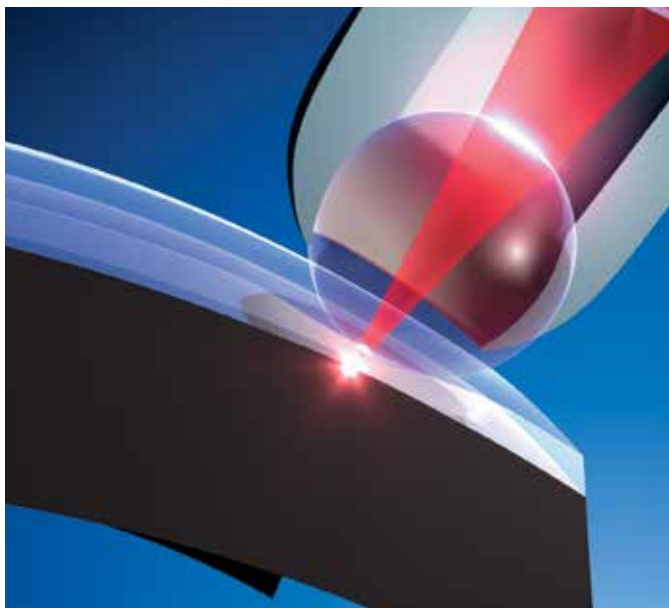

LEISTER

LASER PLASTIC WELDING

Leister's innovative and patented laser bonding solutions provide alternative production processes in automotive, medical, sensor, electronics and textile manufacturing as well as microsystems technology. Our clean, precise and non-invasive laser technology can also be applied to process heat applications.

Plastic welding with Leister

Leister Technologies AG provides the appropriate high quality welding device for all sectors of the plastics processing industry. Our tools are used in sealing systems on roofs, plastic sheeting, floor coverings, in earthworks, hydraulic and tunnel engineering, equipment manufacturing and vehicle repair. However demanding the task, we provide an applicable solution.

Research and development

With years of experience in plastic processing and industrial processes we are the ideal partner to work your plastic application. We have dedicated ourselves to constantly develop new and to persistently improve existing products. We strive to provide our customers with outstanding quality, reliability, performance and cost-efficient products.

Quality management

As an innovative company, Leister commits to transparent and consistent quality management. Leister Technologies AG is certified to comply with the ISO 9001 quality standards. All processes are regularly audited and improved to comply with all quality-relevant criteria; therefore, our products enjoy a reputation of providing reliable service even after years of use under adverse conditions.

Testing and certification

Our products are designed and developed to comply with nationally and internationally recognized standards. This includes both product-specific standards – such as ISO, IEC, EN or UL standards – as well as application-specific standards. For our client's protection, tests are carried out by accredited and independent test institutes. The products are then certified and qualified to carry the marking of conformity.

Application and laboratory testing

Our team of experts will assist you in choosing the right equipment for your application process. Running test series on your applications will help optimize processes. The equipment of the application laboratory allows comprehensive testing for process analysis and documentation of the results.

More than 130 Sales and Service Centers in more than 100 countries

We believe that the basis for customer satisfaction lies within the quality of our products and the smooth running global service network. A close network of more than 130 sales and service centers in more than 100 countries ensures competent and responsive service. Distributors and their staff are trained and certified by Leister on a regular basis; therefore, Leister know-how is locally available to you at all times.



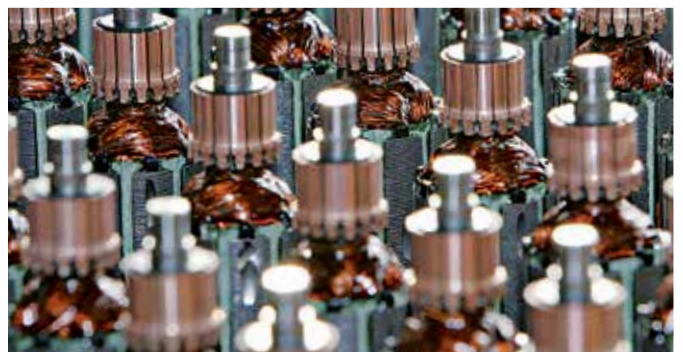



















GEOSTAR G5/G7



Contents

<ul style="list-style-type: none">  Roofing  Technical Textiles and industrial Fabrics  Civil Engineering / GEO  Plastic Fabrication  Flooring and Interior Decoration 	<ul style="list-style-type: none"> Hot-air hand tools 8 – 37 Blowers General accessories Welding rods <li style="padding-left: 20px;">Special applications  <li style="padding-left: 20px;">Shrinking  	
<ul style="list-style-type: none"> Roofing 	<ul style="list-style-type: none"> Automatic welders 38 – 49 Testing instruments  	
<ul style="list-style-type: none"> Technical Textiles and Industrial Fabrics Advertising (signs and banners) Tarpaulins / coverings for trucks Architecture Inflatable / hoses and filters Outdoor & clothing 	<ul style="list-style-type: none"> Automatic welders 50 – 69  	
<ul style="list-style-type: none"> Civil Engineering / GEO Tunnelling Landfill construction Mining Ponds and reservoirs Reservoirs and fisheries 	<ul style="list-style-type: none"> Automatic welders 70 – 91 Extrusion welders Testing instruments  	
<ul style="list-style-type: none"> Plastic Fabrication 	<ul style="list-style-type: none"> Extrusion welders 92 – 109 Welding rods  	
<ul style="list-style-type: none"> Flooring and Interior Decoration Welding floor coverings Groove cutting 	<ul style="list-style-type: none"> Hot-air welder 110 – 123 Grooving machine  	

Hot-Air Hand Tools

Roofing

Technical Textiles and Industrial Fabrics

Civil Engineering / GEO

Plastic Fabrication

Flooring and Interior Decoration



Hot-Air Hand Tools

Product overview	10 / 11
TRIAC ST	12 – 15
TRIAC AT	13 – 15
ELECTRON ST	16 / 17
HOT JET S	18 / 19
SOLANO AT	20 / 21
GHIBLI AW	22 / 23
GHIBLI	25
HOTWIND PREMIUM / SYSTEM	26
FORTE S3	27
AIRSTREAM ST	28 / 29
ROBUST	30
WELDING PEN R / WELDING PEN S	31
DIODE PID / DIODE S	32 / 33
MINOR	33
LABOR S	34
General accessories	36
Welding wires	37



TRIAC ST for use in the roughest of environments.



HOT JET S ideal for detail work on the roof.















DIODE S for use with draw welding on a tank detail.

Product overview Hot-air hand tools

									
Type	TRIANC ST	TRIANC AT	ELECTRON ST	HOT JET S	SOLANO AT	GHIBLI AW	GHIBLI	HOTWIND	FORTE S3
Voltage V~	230 / 120	230 / 120	230 / 120	230 / 120	230	120/230	120/230	230	3 × 230 / 3 × 400
Max. power W	1600	1600	2400 / 3400	460	2300	1800 / 2300	1500 / 2000	3700	10 000
Temperature °C	40 – 700	40 – 620	40 – 650	40 – 600	50 - 650	65 – 620	40 – 600	20 – 650	20 – 650
Size mm (L × W × H) Handle (∅)	338 × 90 56	338 × 90 56	338 × 90 56	235 × 70 40	270 × 75 × 240 45	280 × 90 × 220 45	195 × 85 × 160 57	332 × 106 × 179	390 × 132 85
Weight kg (without cord)~	1.0	1.0	1.1	0.4	0.75	1.1	0.9	2.2	4.4
Integrated blower	✓	✓	✓	✓	✓	✓	✓	✓	✓
Digital display		✓			✓	✓		✓(SYSTEM)	
Conformity mark	CE	CE	CE	CE	CE	CE	CE		CE
Approval mark	Ⓢ Ⓚ	Ⓢ Ⓚ	Ⓢ Ⓚ	Ⓢ Ⓚ	Ⓚ	Ⓢ		Ⓚ	Ⓢ
Protection class	□	□	□	□	□	□	□	□	□
Applications									
Outdoor use	✓	✓	✓	✓		✓			✓
Roofing 	✓	✓	✓	✓					
Billboards / Tarpaulins 	✓	✓		✓	✓				
Civil engineering / Tunneling / Landfills 	✓	✓	✓						
Plastic fabrication 	✓	✓		✓					
Flooring / Interior design 	✓	✓	✓	✓					
Shrinking 	✓	✓	✓	✓	✓	✓	✓	✓	✓
Special applications 					✓	✓	✓	✓	✓
Catalog page 	12 – 15	13 – 15	16 / 17	18 / 19	20 / 21	22 / 23	25	26	27

Product overview Hot-air hand tools and Blower

						
Type	AIRSTREAM ST	ROBUST	WELDING PEN R / S	DIODE PID / S	MINOR	LABOR S
Voltage V~	230	3 × 230 / 3 × 400	230	230	230	230
Max. power W	215	250	1000	1600 / 2000	100	800 / 900
Temperature °C			20 – 600	20 – 600		20 – 600
Size mm (L × W × H) Handle (Ø)	600 × 250 × 362	255 × 221	270 × 43 32	265 × 57 40	250 × 95 64	180 × 54 32
Weight kg (without cord)~	24	8.0	1.0	1.15	1.15	0.15
Integrated blower	✓	✓			✓	
Digital display			✓ (R)	✓ (PID)		
Conformity Mark	CE		CE	CE	CE	CE
Approval mark						
Protection Class	⊕	⊕	□	□	□	□
Applications						
Indoor use	✓	✓	✓	✓	✓	✓
Roofing 						
Billboards / Tarpaulins 						
Civil engineering / Tunneling / Landfills 						
Plastic fabrication 	✓	✓	✓	✓	✓	✓
Flooring / Interior design 						
Shrinking 	✓			✓		✓
Catalog page 	28 / 29	30	31	32 / 33	33	34

TRIAC ST: Design meets experience

The new TRIAC ST from Leister is primarily used for welding and plastic fabrication. During its development, a deliberate choice was made to do without extra technical features. Instead it is distinguished by comfort, being reliable versatile, robust and user friendly, like its predecessor the TRIAC S. A prominent feature here is the two-component handle, which is not only attractive, but also gives the user perfect grip. The low weight of less than 1 kg/2.18 lbs ensures a perfect weight balance.

Product advantage



Ergonomic handling:
The 2-component handle and perfect tool balance ensure ideal grip and optimum working even under the toughest conditions.

Perfect weight:
Weighing less than 1 kg, the TRIAC ST is even lighter than its predecessor.



Always keeps a cool head:
There is an actively cooled protective tube for greater work safety.



Welding power:
Thanks to the optimized, highly robust motor, TRIAC ST guarantees high welding power.

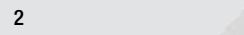

Reliability:
A new temperature manager and a high dust resistance provide the heating elements with a long service life.



Swiss thoroughness:
The air filters, located on either side, can easily be removed and cleaned. This ensures optimum air flow and maximum power output.

Optimum protection:
The filters offer active protection against moisture and dust.

TRIAC AT: Robust and intelligent.

The TRIAC AT is an intelligent hot-air hand tool for welding and shrinking plastics that is suitable for on-site use. It is designed for the needs of even the most demanding professional. Every tool undergoes stringent quality checks prior to leaving the factory in Switzerland. This high-quality hot-air hand tool is equipped for all situations. Its universal areas of application are virtually unlimited. The TRIAC AT will continue to prove its merit in any weather condition and is just as effective outside as it is indoors – all during continuous operation.

Hot-air hand tool

TRIAC ST



- Suitable for the work site
- Functional design: two-component handle grip and optimum center of gravity ensure good ergonomics
- Quick clean air filters
- Automatic carbon stop and heating element protection provide automatic protective measures

Technical data

Voltage	V~	120 / 230
Frequency	Hz	50 / 60
Power	W	1600 / 1600
Temperature	°C	40 – 700
Air volume (20°C)	l/min	240 (500 at max. temp)
Dynamic pressure	Pa	3000
Ø Nozzle holder	mm	31.5
Emission	dB(A)	67
Size (L × Ø)	mm	338 × 90, handle Ø 56
Weight	kg	<1 (without power cord)
Conformity mark	CE	
Approval mark		
Protection class II		

Article No.:

141.308	TRIAC ST, 120 V / 1600 W for push-fit nozzles with UK-plug
141.309	TRIAC ST, 230 V / 1600 W for push-fit nozzles with UK-plug
141.311	TRIAC ST, 230 V / 1600 W for push-fit nozzles with CH plug
141.227	TRIAC ST, 230 V / 1600 W for push-fit nozzles with Euro plug
144.013	TRIAC ST, 230 V / 1600 W for screw-on nozzles with Euro plug
153.891	TRIAC ST, 220 V / 1600 W for push-fit nozzles with KR-plug

Hot-air hand tool

TRIAC AT



- Suitable for the work site
- Closed loop controlled temperature
- Open loop controlled air volume
- Intelligent «e-Drive» operating unit
- Ergonomic handling
- Modern design

Technical data

Voltage	V~	120 / 230
Frequency	Hz	50 / 60
Power	W	1600 / 1600
Temperature	°C	40 – 620
Air volume (20°C)	l/min	160 – 240 (500 at max. temp)
Dynamic pressure	Pa	1600 – 3000
Ø Nozzle holder	mm	31.5
Emission	dB(A)	67
Size (L × Ø)	mm	338 × 90, handle Ø 56
Weight	kg	1 (without power cord)
Conformity mark	CE	
Approval mark		
Protection class II		

Article No.:

141.319	TRIAC AT, 120 V / 1600 W, with UK-plug
141.320	TRIAC AT, 230 V / 1600 W, with UK-plug
141.314	TRIAC AT, 230 V / 1600 W, with Euro-plug
141.322	TRIAC AT, 230 V / 1600 W, with CH-plug
142.737	TRIAC AT, 230 V / 1600 W for screw-on nozzles with Euro plug
148.005	TRIAC AT, 220 V / 1600 W, for push-fit nozzles with KR-plug



Overlap welding

Accessories TRIAC ST / TRIAC AT

	<p>Wide slot nozzle</p> <p>107.123 20 mm, 15° angled</p> <p>107.132 40 mm, 15° angled</p> <p>107.133 40 mm, perforated</p> <p>107.135 40 mm, PTFE-coated</p> <p>107.129 60 mm for bitumen</p> <p>107.131 80 mm for bitumen</p>		107.124 20 mm angled nozzle, 70°, push-fit
	<p>Wide slot nozzle</p> <p>105.475 20 mm, straight</p> <p>105.485 25 mm, straight</p> <p>105.494 30 mm, 15° angled</p>		105.431 3 mm speed weld nozzle, with small air-slide, push-fit on Ø 5 mm tubular nozzle
	105.487 Wide slot nozzle 20 mm, curved and angular, with clamping angle inwards		105.432 4 mm speed weld nozzle, with small air-slide, push-fit on Ø 5 mm tubular nozzle
	105.500 Wide slot nozzle 20 mm, 120° angled (right) 30° slanted forward openly		105.433 5 mm speed weld nozzle, with small air-slide, push-fit on Ø 5 mm tubular nozzle
	<p>107.130 Wide slot nozzle 40mm, 60° bent</p> <p>107.125 20 mm angled nozzle, 60°, push-fit, for right hander</p> <p>105.503 20 mm angled nozzle, 60°, push-fit</p>		107.139 4.5 x 12 mm speed weld nozzle for fillet weld, push-fit on Ø 5 mm tubular nozzle
	100.303 Ø 5 mm, tubular nozzle, push-fit		107.137 8 mm speed weld nozzle for tape welding, push-fit on Ø 5 mm tubular nozzle
	105.575 Ø 5 x 100 mm, tubular nozzle, push-fit		Speed weld nozzle, push-fit on Ø 5 mm tubular nozzle
	106.982 Ø 5 x 150 mm, extension nozzle, push-fit		106.992 5.7 mm, profile A
	105.576 tubular nozzle Ø 5 mm, 90° curved		106.993 7 mm, profile B
	106.996 Tacking nozzle, push-fit on Ø 5 mm tubular nozzle		106.989 Ø 3 mm
			106.990 Ø 4 mm
			106.991 Ø 5 mm
			156.470 Speed weld nozzle bend Ø 5 mm, push-fit on Ø 5 mm tubular nozzle



Mirror welding

More at the new accessories catalog at











www.leister.com/accessories



Draw welding



Shrinking

	105.622 Ø 5 mm, tubular nozzle, screw-on
	106.988 Tacking nozzle, screw-on
	126.552 Ø 4 mm drawing nozzle, screw-on for fluor plastics
	113.666 Ø 3 mm drawing nozzle with tacking tip, screw-on
	113.399 Ø 4 mm drawing nozzle with tacking tip, screw-on
	113.876 Ø 3 mm drawing nozzle without tacking tip, screw-on
	113.874 Ø 4 mm drawing nozzle without tacking tip, screw-on
	113.670 Drawing nozzle triangular-shaped With tacking tip, screw-on 5.7 mm, profile A
	113.877 Without tacking tip, screw-on 5.7 mm, profile A
	106.986 Without tacking tip, screw-on 7 mm, profile B
	106.987 Without tacking tip 7 × 5.5 mm
	157.717 Protection nozzle 31.5 mm, air outlet 23 mm, protection ring 80 mm
	107.344 135 mm welding mirror, push-fit
	143.833 Nozzle adapter for screw-on nozzles
	143.332 Protection tube for screw-on nozzles (for TRIAC ST until april 2017)
	156.092 Protection tube for screw-on nozzles (for TRIAC ST from mai 2017)
	144.134 Protection tube for screw-on nozzles (for TRIAC AT)
	141.375 Connection adapter M14 for Ø 21 mm nozzle with plug

	107.324 12 × 10 mm sieve reflector, push-fit on Ø 8 mm tubular nozzle
	107.337 50 × 35 mm sieve reflector, push-fit
	107.338 35 × 20 mm sieve reflector, push-fit
	107.326 25 × 150 mm shell reflector, push-fit
	107.307 27 × 35 mm spoon reflector, push-fit
	107.339 17 × 34 mm soldering reflector, push-fit
	106.128 7.5 mm soldering reflector
	142.717 Heating element for TRIAC ST / TRIAC AT, 230 V / 1550 W
	142.718 TRIAC ST / TRIAC AT, 120 V / 1550 W

More at the new accessories catalog at

General accessories

ELECTRON ST: Strong, compact and handy

The new ELECTRON ST is a real powerhouse among Leister's hand tools. The appearance of this tool has been modeled after the new TRIAC range. For the user, this means improved ergonomics and, as a result, the ability to work in more comfort. Existing ELECTRON nozzles fit the new model.

Product advantages



Powerful:
Suitable for any application thanks to its outstanding power rating of up to 3400 W.



Perfekte Ergonomie:
100 lighter and with a 2-component handle that's nearly 8 mm slimmer than its predecessor.



Infinitely adjustable:
Easy air temperature adjustment up to 650 °C.

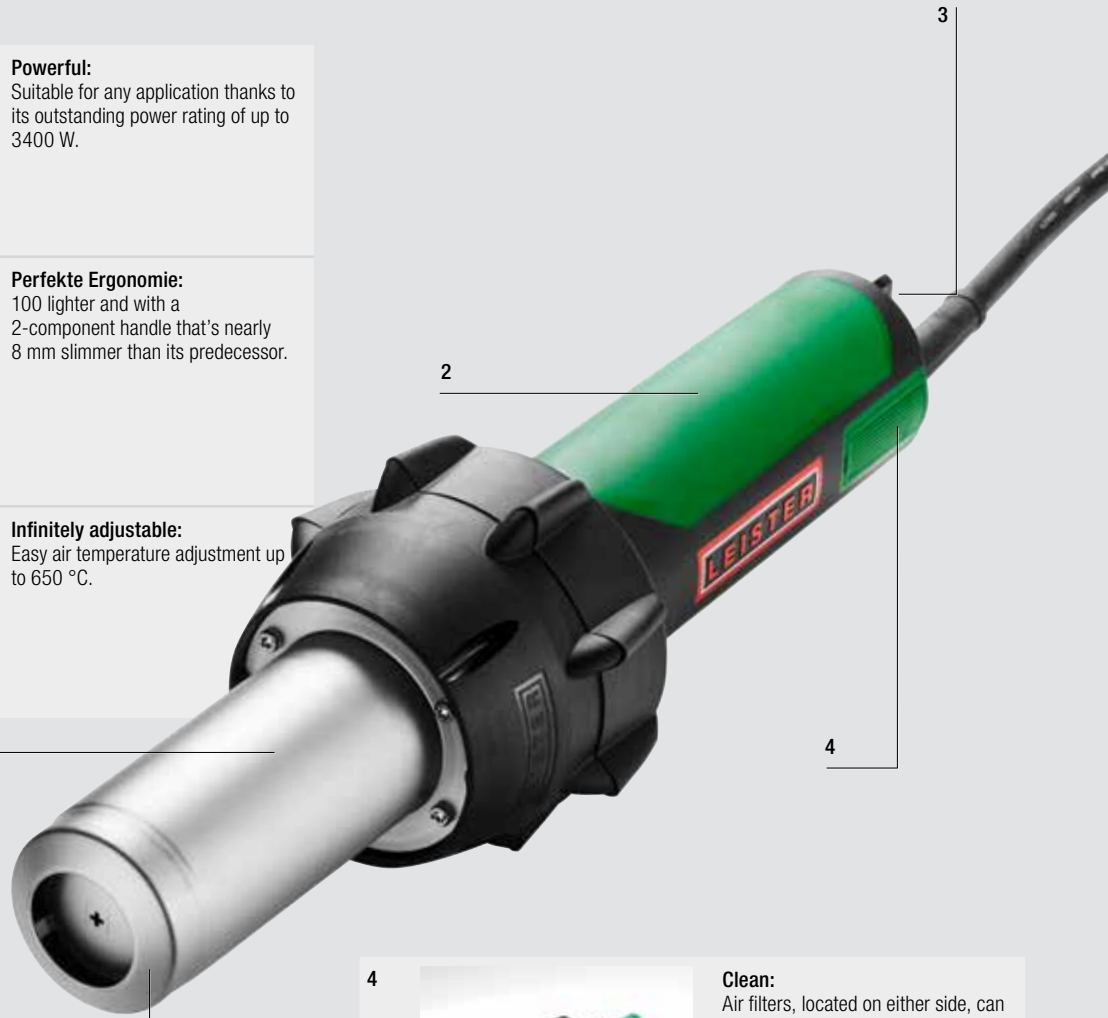

Clean:
Air filters, located on either side, can be removed and cleaned in no time at all.



Compatible:
All predecessor nozzles fit the ELECTRON ST.



Shrinking cable connections is just one of many applications for which the ELECTRON ST can be used.

Hot-air hand tool

ELECTRON ST



- Suitable for construction sites
- Leister's most powerful hand tool
- Easy-clean air filter
- Carbon stop and heating element protection provide automatic protective measures
- Sturdy tool case supplied

Technical data

Voltage	V~	230 / 230 / 200 / 120
Frequency	Hz	50 / 60
Power	W	2300 / 3400 / 3000 / 2400
Temperature	°C	40 – 650
Air volume (20°C)	l/min	360 (700 at max. temp)
Dynamic pressure	Pa	3400
Ø Nozzle holder	mm	50
Emission	dB(A)	67
Size (L × Ø)	mm	338 × 90, handle Ø 56
Weight	kg	1.1 (without power cord)
Conformity mark		CE
Approval mark		Ⓢ Ⓚ
Protection class II		Ⓜ

Article No.

145.567	ELECTRON ST, 230 V / 3400 W for push-fit nozzles with Euro plug
149.673	ELECTRON ST, 230 V / 2300 W for push-fit nozzles with Euro plug
145.563	ELECTRON ST, 120 V / 2400 W for push-fit nozzles with UK plug
145.568	ELECTRON ST, 230 V / 3400 W for push-fit nozzles with UK plug
154.839	ELECTRON ST, 220 V / 3400 W for push-fit nozzles with KR-plug

Accessories ELECTRON ST

	107.258	Wide slot nozzle, push-fit 70 × 10 mm, for bitumen
	107.653	Wide slot nozzle 75 × 2 mm, push-fit
	151.068	Tool stand for ELECTRON ST
	107.270	Wide slot nozzle 150 × 12 mm, push-fit
	107.229	Round nozzle 20 mm
	107.331	72 × 70 mm folding reflector, push-fit
	107.330	125 × 22 mm folding reflector, push-fit
	107.327	85 × 85 mm sieve reflector, push-fit
	107.333	130 × 150 mm sieve reflector, push-fit
	106.127	Ø 65 mm sieve reflector push-fit
	107.340	45 × 250 mm Shell reflector, push-fit
	107.346	270 mm welding mirror, push-fit
	142.281	Scraper nozzle
	107.134	Tape welding nozzle 40 mm
	160.842	Protection nozzle, air outlet 44 mm, protection ring 100 mm
	148.933	Protective tube
	145.606 149.675 145.604	Heating elements 230 V / 3300 W 230 V / 2200 W 120 V / 2300 W

More at the new accessories catalog at

General accessories

HOT JET S: Small and powerful.

As the most compact hot-air hand tool from Leister, the HOT JET S' low weight of 600 grams (including cord and slim handle) ensures high-powered, fatigue-free welding.



Especially suited for precise work.

Hot-air hand tool

HOT JET S



- The smallest Leister hot-air hand tool
- Stepless, electronically controlled temperature
- Stepless, electronically controlled air flow
- Low noise
- Flexible, integrated tool stand

Technical data

Voltage	V~	120 / 230
Frequency	Hz	50 / 60
Power	W	460 / 460
Temperature	°C	40 – 600
Air volume (20°C)	l/min	40 – 110 (200 at max. temp)
Pressure static	Pa	230 – 1600
Ø Nozzle holder	mm	21.3
Emission	dB(A)	59
Size (L × Ø)	mm	235 × 70, handle Ø 40
Weight	kg	0.4 (without power cord)
Conformity mark	CE	
Approval mark		
Protection class II		

Article No.:

100.648	HOT JET S, 230 V / 460 W, with Euro plug
100.862	HOT JET S, 120 V / 460 W, without plug
100.854	HOT JET S, 230 V / 460 W, with AUS plug
140.030	HOT JET S, 220W/ 460W for push-fit nozzles with KR-plug

Accessories HOT JET S

	107.141	15 mm wide slot nozzle, push-fit
	107.142	20 mm wide slot nozzle, push-fit
	105.549	10 × 2 mm wide slot nozzle
	107.144	Ø 5 mm tubular nozzle, push-fit
	105.567	Ø 5 × 150 mm extension nozzle, straight
	105.566	Ø 5 mm tubular nozzle, straight
	105.556	20 mm angled nozzle, 70° angled, push-fit
	106.996	Tacking nozzle, push-fit on Ø 5 mm tubular nozzle
	106.989	3 mm speed welding nozzle, push-fit on Ø 5 mm tubular nozzle
	106.990	4 mm speed welding nozzle, push-fit on Ø 5 mm tubular nozzle
	106.991	5 mm speed welding nozzle, push-fit on Ø 5 mm tubular nozzle
	156.470	Speed weld nozzle bend Ø 5 mm, push-fit on Ø 5 mm tubular nozzle
	106.992	5.7 mm, A profilee speed welding nozzle, push-fit
	106.993	7 mm, B profilee speed welding nozzle, push-fit
	105.431	3 mm speed welding nozzle, with small air-slide, push-fit on Ø 5 mm tubular nozzle
	105.432	4 mm speed welding nozzle, with small air-slide, push-fit on Ø 5 mm tubular nozzle
	105.433	5 mm speed welding nozzle, with small air-slide, push-fit on Ø 5 mm tubular nozzle



HOT JET S with angled nozzle welding a T-joint on the roof.



Fitting a solder shrink connection with the HOT JET S outfitted with a push-fit sieve reflector.

	107.137 8 mm speed welding nozzle for tape welding, push-fit on Ø 5 mm tubular nozzle
	107.139 4.5 x 12 mm speed welding nozzle for fillet weld, push-fit on Ø 5 mm tabular nozzle
	107.324 12 x 10 mm sieve reflector, push-fit on Ø 5 mm tubular nozzle
	107.146 Ø 2 mm soldering nozzle
	107.151 Ø 4 mm soldering nozzle
	107.148 Ø 3 x 1.5 mm soldering nozzle, oval
	107.310 35 x 20 mm sieve reflector, push-fit
	107.311 50 x 35 mm sieve reflector, push-fit
	107.312 25 x 30 mm spoon reflector, push-fit
	107.305 15 x 25 mm ironing nozzle
	143.831 Nozzle adapter for screw-on nozzles
	114.734 Ski repair nozzle with base plate
	100.818 230 V / 435 W heating element
	103.607 120 V / 435 W heating element

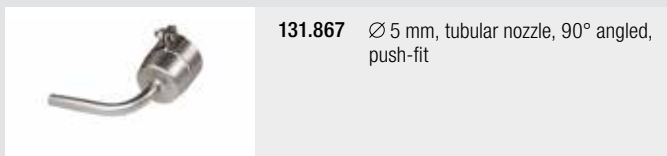

131.867 Ø 5 mm, tubular nozzle, 90° angled, push-fit

Small and handy: The HOT JET S is perfect when welding complicated details in billboard and tarpaulin applications.



More at the new accessories catalog at

General accessories

SOLANO AT: Light, quiet, durable

From our dialog with you, we know what you need. When we were developing the SOLANO AT, we focused on your requirements. This is why it is lighter, quieter and more durable than any other hot-air hand tool. Discover its unbeatable advantages – SOLANO AT.

Heat gun

SOLANO AT



Practical dust filter:
Robust, fine-mesh and easy to clean dust filter (exchangeable).



Customizable temperature and air flow limit values



Customizable direct start-up



Operating keys:
180° panorama soft-touch keypad for convenient operation.



Customizable cooling function



Customizable power management



Burn protection – A.B.D (anti-burn design):
For a safe handling of the hot-air blower.



Ergonomic:
due to its convenient design





SOLANO AT – Difficult leather parts – safe and efficient processing

Heat gun

SOLANO AT



- **Long-lasting:** thanks to the brushless motor and sturdy LEISTER heating element
- **Light and quiet:** weighs 750 g and runs extremely smoothly at < 65 dB for efficient and effortless operation
- **Economical:** saves up to 40% energy in Eco mode
- **Safe:** due to its multi-level system to protect against overheating
- **Simple:** due to its intuitive operation
- **Controlled:** consistent performance due to the intelligent temperature controller
- **Versatile:** suitable for numerous applications in various industries

Technical data

Voltage	V~	100	120	230
Power	W	1500	1800	2300
Temperature	°C	50 – 650		
Air volume	l/min (20°C)	160 – 300 [550 at max. temp]		
Emission	dB (A)	< 65		
Dimensions L x W x H (Ø handle)	mm	270 x 75 x 240 (45)		
Weight	g	750		
Conformity mark				CE
Approval mark				K
Protection class II				□

Article No.:

- 162.269 SOLANO AT 230 V / 2300 W with AUS plug, box (162.270 casing)
 - 162.271 SOLANO AT 220 V / 2100 W with KR plug, box (162.272 casing)
 - 162.273 SOLANO AT 120 V / 1800 W with US plug, box (162.274 casing)
 - 162.275 SOLANO AT 100 V / 1500 W with JP plug, box (162.276 casing)
- Scope of delivery: SOLANO AT, box / casing

Accessories SOLANO AT

	106.998	Wide slot nozzle 20 mm, push-fit
	106.999	Wide slot nozzle 40 mm, push-fit
	107.154	Tubular nozzle Ø 5 mm, push-fit
	107.006	Extension nozzle Ø 5 x 130 mm, straight
	107.308	Sieve reflector 50 x 35 mm
	107.309	Sieve reflector 35 x 20 mm
	107.313	Spoon reflector 25 x 30 mm, with screw connector
	107.314	25 x 30 mm spoon reflector, push-fit
	107.319	Sieve reflector Ø 65 mm
	147.222	Heat protection device
	162.067	Heating element, 230 V / 2200 W
	162.068	Heating element, 120 V / 1700 W
	162.069	Heating element, 100 V / 1450 W

More at the new accessories catalog at

General accessories

GHIBLI AW: Robust and ergonomic.

The GHIBLI AW is the robust and ergonomic heat gun used for shrink in cable manufacturing, heating and forming in the automobile industry, lap welding of truck sheeting and for deburring plastic parts. Thanks to the easy-to-grip, two-component frame, the GHIBLI AW fits perfectly in the hand. Temperature and air volume can easily be adjusted with the proven and intuitive "e-Drive" operating unit. The stand that is included in the scope of delivery and the

Heat gun

GHIBLI AW



Stand:
Thanks to the included stand, the GHIBLI AW can be placed in an optimum position at the workstation, thus reducing fatigue.



Practical air filter
Regular cleaning of the air filters ensures optimum air flow and maximum power.



Leister e-Drive
Temperature and air volume are easy to control and inspect with the proven "e-Drive" operating unit – for reproducible results.



Fatigue-free working
Thanks to the integrated suspension lug, the GHIBLI AW can be suspended for fatigue-free work.



Compatible
All of its predecessor's nozzles also fit on the GHIBLI AW. Comprehensive selection of compatible accessories.



Ergonomic handling
The two-component handle and the perfect device balance ensure an optimal grip and comfortable work, even under the harshest of conditions.



practical device suspension make working easier. The air filters can be readily removed and cleaned. And of course, all of the nozzles from its predecessor fit the new GIBLI AW.



Shrink applications in cable manufacturing – ideal with the GIBLI AW

Heat gun

GIBLI AW



- Ergonomic heat gun
- Digital temperature control
- Five-stage air volume control
- "e-Drive" operating unit for optimum process control
- 100% Swiss Made

Technical data

Voltage	V~	230 / 120
Frequency	Hz	50 / 60
Power	W	2300 / 1800
Temperature	°C	65 – 620
Air volume (20°C)	l/min	230 – 330 (600 at max. temp)
Pressure static	Pa	1800 – 3200
Ø Nozzle holder	mm	36.5
Emission	dB(A)	67
Dimensions (L × W × H)	mm	280 × 90 × 220, Handle Ø 45
Weight	kg	1.1 (without power cord)
Conformity mark		CE
Approval mark		Ⓢ
Protection class II		□

Article No.:

- 148.061 GIBLI AW, 230 V / 2300 W, Euro plug
 - 150.168 GIBLI AW, 230 V / 2300 W, UK plug
 - 150.169 GIBLI AW, 230 V / 2300 W, CH plug
 - 150.170 GIBLI AW, 120 V / 1800 W, CEE plug
 - 148.079 GIBLI AW, 100 V / 1500 W, JP plug
- Scope of delivery: GIBLI AW, case, stand, quick guide

Accessories for GIBLI AW

	106.998	Wide slot nozzle 20 mm, push-fit
	106.999	Wide slot nozzle 40 mm, push-fit
	107.154	Tubular nozzle Ø 5 mm, push-fit
	107.006	Extension nozzle Ø 5 × 130 mm, straight
	107.308	Sieve reflector 50 × 35 mm
	107.309	Sieve reflector 35 × 20 mm
	107.313	Spoon reflector 25 × 30 mm, with screw connector
	107.314	25 × 30 mm spoon reflector, push-fit
	107.319	Sieve reflector Ø 65 mm
	107.345	Welding mirror 135 mm, push-fit
	158.474	Protection nozzle, air outlet Ø 23 mm, protection ring Ø 80 mm
	107.007	Ø 37 mm Dehorning nozzle
	106.132	45 × 250 mm Shell reflector, push-fit
	145.582	Heating element, 230 V / 2200 W
	145.580	Heating element, 120 V / 1700 W

More at the new accessories catalog at

General accessories





GHIBLI: “The hot-air gun”.

GHIBLI, derived from a hot desert wind, certainly lives up to its name. Thanks to its two-step airflow switching and steplessly adjustable temperature, the GHIBLI can be used for the most diverse applications.



Shrinking cable connections with the GHIBLI.

Hot-air hand tool

GHIBLI



- Universal tool for welding and shrinking
- Welding results independent of voltage fluctuations and ambient temperature
- Two-step selectable airflow

Technical data		
Voltage	V~	120 / 230
Frequency	Hz	50 / 60
Power	W	1500 / 2000
Temperature	°C	40 – 600
Air volume (20°C)	l/min	250 / 300 (500 at max. temp)
Ø Nozzle holder	mm	36.5
Emission	dB(A)	70
Size (L × W × H))	mm	195 × 85 × 160, Handle Ø 57
Weight	kg	0.9 (without power cord)
Conformity mark		CE
Approval mark		
Protection class II		

Article No.:

101.881	GHIBLI 230 V / 2000 W with Euro plug
101.887	GHIBLI 120 V / 1500 W with US plug

Additional versions available upon request.

Accessories GHIBLI

	106.998	20 mm wide slot nozzle, push-fit
	106.999	40 mm wide slot nozzle
	107.154	Ø 5 mm tubular nozzle, push-fit
	107.006	Ø 5 × 130 mm extension nozzle, straight
	107.308	34 × 50 mm sieve reflector
	107.309	20 × 35 mm sieve reflector
	107.313	25 × 30 mm spoon reflector, with screw connector
	107.314	25 × 30 mm spoon reflector, push-fit
	107.319	Ø 65 mm sieve reflector
	158.474	Protection nozzle, air outlet Ø 23 mm, protection ring Ø 80 mm
	107.007	Ø 37 mm Dehorning nozzle
	107.345	135 mm welding mirror, push-fit
	106.132	150 × 25 mm Shell reflector, push-fit
	115.513	230 V / 1800 W heating element
	101.850	120 V / 1500 W heating element

More at the new accessories catalog at

General accessories



HOTWIND: The new dimension.

Weighing just 2.2 kg, the HOTWIND can be used either as an integrated or bench-top device. The high maximum temperature of 650 °C means that the HOTWIND can be used in a variety of ways.



HOTWIND SYSTEM with wide slot nozzle integrated in a blow-off application.

Hot-air hand tool

HOTWIND PREMIUM / SYSTEM



HOTWIND SYSTEM

- Ideal for warming, heating, forming and drying
- Stepless adjustment of the heating and blower
- Integrated device and heating element protection
- Extremely smooth running
- Ideal for 24/7 operation

Technical data

Voltage	V~	230
Power	W	3700
Temperature	°C	650
Size (L × W × H)	mm	332 × 106 × 179
Weight	kg	2.2 (without power cord)
Approval mark		
Protection class II		

Article No.:

142.609 HOTWIND PREMIUM, 230 V / 3700 W, with Euro plug
 142.645 HOTWIND SYSTEM, 230 V / 3700 W, with Euro plug

Additional versions available upon request

Accessories

HOTWIND PREMIUM / SYSTEM

		Wide slot nozzle, push-fit (a × b)
		<p>107.260 85 × 15 mm</p> <p>107.259 150 × 12 mm</p> <p>105.977 200 × 9 mm</p> <p>107.263 250 × 12 mm</p> <p>107.262 300 × 4 mm</p> <p>105.992 400 × 4 mm</p> <p>105.991 500 × 4 mm</p>
		125.317 Flange connector, push-fit a = 90 mm
		107.335 Ø 150 mm sieve reflector, push-fit
		107.248 Stainless steel filter, push-fit on air intake
		141.723 Hand tool kit (handle and protective tube)
		143.530 230 V / 3600 W heating element

FORTE S3: Flameless shrinking.

The most powerful hot-air hand tool from Leister. The FORTE S3 is extremely well-suited for flameless shrinking of pallets and bulky goods.



Flameless shrink-wrapping of pallets and bulky goods with the FORTE S3.

Hot-air hand tool

FORTE S3

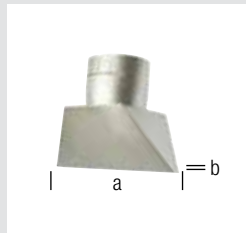

	Wide slot nozzle, push-fit (a × b)
106.028	220 × 12 mm
107.272	300 × 12 mm
106.018	400 × 10 mm
106.024	500 × 7 mm
107.267	500 × 15 mm
106.023	600 × 4 mm
106.026	600 × 9 mm

- Powerful pallet shrink-wrapping
- Uniform shrinkage
- May be used in confined spaces
- Integrated tool stand

Technical data			
Voltage	V~	3 × 230	3 × 400
Power	kW	10	10
Temperature	°C	650	
Size (L × Ø)	mm	390 × 132, handle Ø 85	
Weight	kg	4.4 (without power cord)	
Conformity mark		CE	
Approval mark		S	
Protection class II		□	
Article No.:			
102.027 FORTE S3, 3 × 400 V / 10 kW with 16A CEE plug			
Additional versions available upon request			

AIRSTREAM ST: The quiet and efficient air supply unit.

With its plug & play functionality, all you need to do is plug in the AIRSTREAM ST for a constant supply of clean, dry air – for welding constructions with the highest cleanliness requirements. Also ideal for use in quiet environments. Need to work with two hand tools in parallel? No problem thanks to the simultaneous power and air supply. The unit includes a hand tool stand, fits into every work bench, and is fitted with castors for easy mobility. A highly practical solution!



1 Dual operation:
The two tool connections enable parallel operation of two tools or offer the added flexibility of having a second hand tool ready for a subsequent work step.



2 The quick-change artist:
It is easy to integrate into the existing environment thanks to its cubic design, and can also be fitted with additional castors for easy mobility. The practical cover can be used as a tool stand. The AIRSTREAM ST can be turned around to fit perfectly into any work bench.



3 Quality is measurable:
If you know what you want, you need to be able to set the air volume using the air volume measuring device. The volume flow is crucial for the input of energy and has a direct influence on the quality of the weld.

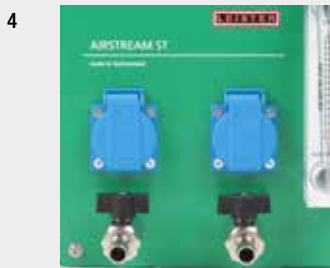

4 Logic for a longer service life:
When the unit is switched on, the hand tools are always supplied with air and power at the same time. In case of reaching the daily target or a significant pause in production, the AIRSTREAM ST prevents the connected tools from overheating by employing its integrated cool-down mode.





AIRSTREAM ST, the quiet air supply unit.

Blower

AIRSTREAM ST



- Quiet operating mode
- Cool-Down-Mode
- Low energy consumption
- Two hand tools can be connected
- Compatible mit WELDING PEN, DIODE and LABOR
- Flow meter
- Brushless technology

Technical Data		
Voltage	V~	230
Power	W	215
Frequency	Hz	50
Air volume	L/min	200 (Total)
Emission	L _{pA} (dB)	< 48 (with 3 m hose)
Size (L x B x H)	mm	600 x 250 x 362 (with handle)
Weight	kg	24
Conformity mark		CE
Protection class I		⊕

Scope of delivery:
Air supply unit, hose transition pieces, clips, quick guide

Article-No.:
158.822 AIRSTREAM ST, 230 V/215 W, EU-plug

Accessories AIRSTREAM ST

	159.535 Roller set
	159.481 Air hose connection set



Easy parallel operation.



A reliable companion.

ROBUST: The powerhouse.

Versatile and operable at high ambient temperatures of up to 60 °C. Despite its small size, the ROBUST is a real powerhouse. This blower can simultaneously supply air for up to three hot-air hand tools.



ROBUST blower, serving as the external air supply for the WELDING PEN.

Blower

ROBUST



- High-performance, compact design
- Sound-suppression
- Can be integrated at any position
- Can be used as an external air supply to 1 WELDING PEN R or up to max. 3 DIODE S / PID or max. 3 LABOR S (with 107.281 hose adapter)

Technische Daten

Frequency	Hz	50	60
Power	W	250	250
Air volume (20 °C)	l/min	1200	1300
Static pressure	kPa	8.0	10.5
Max. ambient temperature	°C	60	60
Max. air inlet temperature	°C	60	60
Noise emission level	dB(A)	62	62
Protection (IEC 60529)		IP 54	IP 54
Outside diameter air inlet	Ø mm	38	38
Outside diameter air outlet	Ø mm	38	38
Weight	kg	8.0	8.0
Conformity mark			
Protection class I		⊕	⊕

Artikel-Nr.:

Voltage V~	50 Hz	1 × 120	1 × 230	3 × 230 / 400
	60 Hz			3 × 440 – 480
Without cord	Article No.:	103.434		103.429
3 m cord / Euro plug	Article No.:		103.432	

Accessories ROBUST

	107.354 Stainless steel filter, push-fit on air intake
	107.281 Ø 38 mm hose connection adapter, 3 output each 14 mm
	113.859 Ø 14 mm air hose
	101.031 Ø 14 mm hose clip for air hose

WELDING PEN: Slim and flexible.

The WELDING PEN is a hot-air hand tool optimized for draw welding. Due to its slim design and swivelling external air supply it makes hard work easy.



WELDING PEN R combined with angle adapters make welding possible even in very tight spaces.

External air hand tool

WELDING PEN R / WELDING PEN S



- Digital temperature display (WELDING PEN R)
- Connection makes working easier.
- Cooled heating element tube
- Used in combination with ROBUST blower or compressed air

Technical data		
Voltage	V~	230
Power	W	1000
Temperature	°C	20 – 600
Size (L × Ø)	mm	270 × 43, handle Ø 32
Weight	kg	1.0 (with 3 m cord / air hose and Y-connection)
Conformity mark		CE
Protection class II		□

Article No.:

- 114.275 WELDING PEN S, 120 V / 600 W, with UK-plug, 2.5 m hose
- 114.380 WELDING PEN R, 230 V / 1000 W, with Euro plug, 2.5 m hose
- 113.081 WELDING PEN S, 230 V / 1000 W, with Euro plug, 2.5 m hose
- 114.926 WELDING PEN R, 230 V / 1000 W, with Euro plug, 6 m hose
- 114.274 WELDING PEN S, 230 V / 1000 W, with Euro plug, 6 m hose
- 114.927 WELDING PEN R, 230 V / 1000 W, with Euro plug, 9 m hose
- 114.273 WELDING PEN S, 230 V / 1000 W, with Euro plug, 9 m hose

Accessories WELDING PEN R / S

	105.622	Ø 5 mm tubular nozzle, 15° screw-on
	106.988	Tacking nozzle, screw-on
	113.666	Ø 3 mm round drawing nozzle with tacking tip, screw-on
	113.399	Ø 4 mm round drawing nozzle, with tacking tip, screw-on
	113.876	Ø 3 mm round drawing nozzle without tacking tip, screw-on
	113.874	Ø 4 mm round drawing nozzle, without tacking tip, screw-on
	113.670	Triangular drawing nozzle with tacking tip, screw-on, 5.7 mm, profile A
	113.877	without tacking tip, screw-on 5.7 mm, profile A
	106.986	without tacking tip, screw-on 7 mm, profile B
	106.987	without tacking tip, screw-on 7 × 5.5 mm
	126.552	Ø 4 mm drawing nozzle, screw-on for fluor plastics
	127.726	Angular adapter for screw-on nozzles, screw-on 30°
	127.727	45°
	141.375	Connection adapter M14 for Ø 21.3 mm nozzle with plug
	113.412	230 V / 1000 W heating element for WELDING PEN R and WELDING PEN S

Swiveling air hose for easy working.



More at the new accessories catalog at

General accessories 36/37

DIODE PID / S: The powerful pair.

There are two options for high-quality work: The closed-loop DIODE PID provides the perfect welding temperature at all times. The DIODE S easily puts you in control with a manual temperature knob.



Convenient wire welding using the powerful and lightweight DIODE PID.

External air hand tool

DIODE PID / DIODE S



- Operated with MINOR or ROBUST blower or with compressed air
- Digitally controlled and displayed temperatures (DIODE PID)
- Cooled heating element tube
- Suitable for field applications when used in combination with a MINOR blower

Technical data

Voltage	V~	120 / 230
Power	W	1600
Temperature	°C	20 – 600
Size (L x Ø)	mm	265 x 57, handle Ø 40
Weight	kg	1.15 kg (with 3 m cord / 3 m air hose)
Conformity mark	CE	
Protection class II	□	

Article No.:

101.303 DIODE PID, 230 V / 1600 W, push-fit, with Euro plug
 101.281 DIODE S, 230 V / 1600 W, push-fit, with Euro plug
 101.304 DIODE PID, 230 V / 1600 W, screw-on, with Euro plug
 101.282 DIODE S, 230 V / 1600 W, screw-on, with Euro plug
 101.293 DIODE S, 120 V/1600 W for push-fit nozzles, with UK-plug

Additional versions available upon request

Hand tool and blower

DIODE PID / DIODE S with MINOR



MINOR blower and DIODE PID with screw-on drawing nozzle.

- Ideal for assembly work

Technical data

Voltage	V~	120 / 230
Power	W	1600
Temperature	°C	20 – 600
Size (L x Ø)	mm	265 x 57, handle Ø 40
Weight	kg	2.5 kg (with 3 m cord / 1.5 m air hose)
Conformity mark	CE	
Protection class II	□	

Article No.:

108.880 DIODE PID with MINOR, 230 V / 1700 W, screw-on, 1.5 air hose, Euro-plug
 101.441 DIODE S with MINOR, 230 V / 1700 W, push-fit, 1.5 air hose, Euro-plug

Additional versions available upon request







The MINOR blower as an air supply for the DIODE PID.

MINOR: The mobile air supplier.







Don't be deceived by the MINOR's small size and low weight. This blower delivers sufficient air to enable quality work with the DIODE PID / DIODE S or LABOR S.

Accessories DIODE PID / DIODE S

With push-fit nozzle

	100.303 Ø 5 mm tubular nozzle, for versions with nozzles, push-fit
	Speed welding nozzle, push-fit on Ø 5 mm tubular nozzle 106.992 5.7 mm, profile A 106.993 7 mm, profile B 106.989 3 mm 106.990 4 mm 106.991 5 mm 156.470 5 mm bent
	106.996 Tacking nozzle, push-fit on Ø 5 mm tubular nozzle
	143.833 Nozzle adapter for screw-on nozzles
	100.296 Heating element DIODE PID, 230 V / 1550 W 100.650 Heating element DIODE PID, 120 V / 1600 W 100.689 Heating element DIODE S, 230 V / 1550 W 100.702 Heating element DIODE S, 120 V / 1600 W

With screw-on nozzle

	105.622 Ø 5 mm tubular nozzle, screw-on
	106.988 Tacking nozzle, screw-on
	113.666 Ø 3 mm round drawing nozzle with tacking tip, screw-on 113.399 Ø 4 mm round drawing nozzle, with tacking tip, screw-on 113.876 Ø 3 mm round drawing nozzle without tacking tip, screw-on 113.874 Ø 4 mm round drawing nozzle, without tacking tip, screw-on
	113.670 Triangular drawing nozzle, with tacking tip, screw-on, 5.7 mm 113.877 Without tacking tip, screw-on 5.7 mm, profile A
	106.986 Without tacking tip, screw-on 7 mm, profile B 106.987 7 x 5.5 mm
	126.552 4 mm drawing nozzle, screw-on, for fluor plastics
	141.375 Connection adapter M14 for Ø 21.3 mm nozzle with plug

More at the new accessories catalog at

Blower

MINOR



- Lightweight and compact
- Powerful
- Serves as a mobile air supply for the DIODE PID / DIODE S and LABOR S
- Suitable for work on construction sites

Technical data

Voltage	V~	230
Power	W	100
Air volume (20°C)	l/min	400
Pressure static	Pa	4000 (40 mbar)
Air outlet (external)	mm	14.5
Size (L x Ø)	mm	250 x 95, handle Ø 64
Weight	kg	1.15 (with 3 m cord)
Conformity mark	CE	
Protection class II	□	

Article No.:

108.747	MINOR, 230 V / 100 W, with Euro plug
109.988	MINOR, 120V / 100W, with UK plug

Additional versions available upon request

LABOR S: Small and handy.

Developed for laboratory use but also eminently suitable for small welding tasks where access is difficult.



LABOR S, used in combination with MINOR as an external air supply.

External Air Hand tool

LABOR S



- Temperature adjustment via rotary knob
- Very small and handy device
- Ideal for draw welding and tacking
- Air supply with ROBUST blower, MINOR (p. 27) or with compressed air
- Ideal for mobile use when coupled with MINOR blower

Technical data

Voltage	V~	230
Power	W	800 / 900
Temperature	°C	20 – 600
Size (L x Ø)	mm	180, handle Ø 32
Weight	kg	0.15 (without air hose and without cord)
Conformity mark	CE	
Approval mark		
Protection class II	□	

Article No.:

- 101.716 LABOR S with connection box, 230 V / 800 W with Euro plug, air hose 3 m
 - 101.754 LABOR with MINOR blower, 230 V / 900 W with Euro plug, air hose 1.5 m
- Additional versions available upon request

Accessories LABOR S

	107.144	Ø 5 mm tubular nozzle, push-fit
	106.992	Speed weld nozzle, push-fit on Ø 5 mm tubular nozzle
	106.993	5.7 mm, profilee A
	106.989	7 mm, profilee B
	106.990	3 mm
	106.991	4 mm
	156.470	5 mm
	156.470	5mm bent
	106.996	Tacking nozzle, push-fit on Ø 5 mm tubular nozzle
	143.831	Nozzle adapter for screw-on nozzles
	107.146	Ø 2 mm soldering nozzle
	107.151	Ø 4 mm soldering nozzle
	107.148	Ø 3 x 1.5 mm soldering nozzle, oval
	105.622	Ø 5 mm tubular nozzle, screw-on
	106.988	Tacking nozzle, screw-on
	113.666	Ø 3 mm round drawing nozzle with tacking tip, screw-on
	113.399	Ø 4 mm round drawing nozzle with tacking tip, screw-on
	113.876	Ø 3 mm round drawing nozzle without tacking tip, screw-on
	113.874	Ø 4 mm round drawing nozzle without tacking tip, screw-on
	113.670	Triangular drawing nozzle, with tacking tip, screw-on, 5.7 mm
	113.877	Without tacking tip, screw-on 5.7 mm, profile A
	106.986	Without tacking tip, screw-on 7 mm, profile B
	106.987	7 x 5.5 mm
	126.552	4 mm drawing nozzle, screw-on, for fluor plastics
	101.581	230 V / 800 W heating element

More at the new accessories catalog at

General accessories

36/37



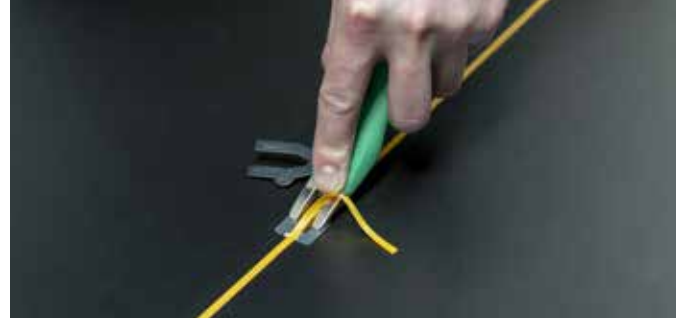

Simple reworking of welding seams with the Leister trimming knife.

Hot-air hand tools

General accessories

	106.974	80 mm silicone pressure roller		160.015	Cable extension cord 15 m, with CEE 400V plug
	140.160	40 mm silicone pressure roller with ball bearings (silicone)		159.239	Cable extension cord 15 m, with EU plug 230V
	140.599	Spare roll for 140.160		106.997	Ø 6 mm rotary burr for drilling machine, for car repairs
	140.161	Pressure roller 28 mm, with ball bearings (silicone)		116.798	Brass brush
	140.598	Spare roll for 140.161		142.647	Brass brush Ø 3 mm
	106.976	28 mm pressure roller (PTFE)		107.348	Tool rest for TRIAC AT, TRIAC ST, ELECTRON ST, HOT JET S, LABOR S
	106.972	Brass pressure roller with ball bearings		137.855	Leister cutter with five spare blades
	117.000	Trimming knife with 0.6 mm spacer for vinyl and linoleum with 5 spare blades included		138.902	Hooked blade for LEISTER-cutter (10 dispenser with 10 pcs=100 pcs)
	117.005	5 spare blades		138.539	Straight-edge blade for LEISTER-cutter (10 dispenser with 10 pcs = 100 pcs)
	117.007	1 universal spacer 0.6 mm		151.382	Inside corner tool
	138.314	Seam probe tester for overlap seams		153.009	Plastfix
	151.188	Chamfer planer for T-joints for sealing sheets		154.259	Scraper blade
	152.676	Weld seam template		154.026	Contour scraper
	157.544	Leister Universal scissors 260 mm with special shaft grinding		116.586	Storage case for TRIAC AT, TRIAC ST, ELECTRON ST
	160.353	Cable cord roller 25 m, with 1 x CEE 400V and 2 x EU socket 230V			
	161.152	Cable cord roller 25 m, with 1 x CEE 400 V and 2 x T23 CH socket 230 V			
	161.207	Cable cord roller 25 m, with 1 x CEE 400 V and 2 x Typ E with ground pin socket 230 V			
	164.048	Cable cord roller 45 m, 4 x 230 V, EU socket			

More at the new accessories catalog at



Welding rods

Article		Profile	Colour	kg
Welding accessories PE				
104.283	HDPE welding rod	A	■	3
104.294	HDPE welding rod	A	□	3
104.284	HDPE welding rod	B	■	5
104.299	HDPE welding rod	B	□	5
106.650	HDPE welding band	C	□	1
104.300	LDPE welding rod	A	■	3
161.612	HDPE welding rod	D	■	2
116.918	HDPE welding rod	D	■	2
Welding accessories PP				
104.287	PP welding rod	A	■	3
104.301	PP welding rod	A	■	3
106.642	PPs welding rod, flame resistant	A	■	3
104.288	PP welding rod	B	■	5
126.356	PP welding band	C	□	2
161.611	PP welding rod	D	■	2
Welding accessories PVC				
104.296	PVC-U welding rod	A	□	3
104.278	PVC-U welding rod	A	■	3
106.641	PVC-U welding rod	A	■	3
104.280	PVC-U welding rod	B	■	5
104.279	PVC-U welding rod	B	■	5
109.925	PVC-U welding rod	D	■	4
104.302	PVC-P welding rod (soft)	A	□	3
Welding accessories ABS				
104.295	ABS welding rod	A	□	3
113.587	ABS welding rod	A	■	3
107.027	ABS welding band	C	□	1

Article		Profile	Colour	kg
Welding accessories div.				
104.297	PA welding rod	A	■	3
104.298	PC welding rod	A	□	3
104.313	PC welding rod / ABS / ALPHA (Honda)	A	■	3
104.308	PUR welding rod	A	■	3
106.654	Xenoy welding band	C	■	2
104.304	PVDF welding rod	A	□	3
104.303	POM welding rod	A	□	3
112.185	PC/PBTP Xenoy welding rod	A	□	3
Test bundles				
107.036	Test bundle bodywork welding rods, each consisting of profile A pieces of 37 cm single marked 6× HDPE, 6× PP, 6× PA, 6× PC, 6× ABS, 6× PCABS / ALPHA Honda, 6× PC / PBTP / Xenoy	A		
107.037	Test bundles standard each consisting of profile A pieces of 37 cm single marked 5× PVC-U, 5× PVC-P, 5× PP, 5× ABS, 5× HDPE, 3× PC, 3× PA, 3× POM, 3× LDPE, 3× PC / ABS / ALPHA Honda, 3× PC / PBTP / Xenoy	A		
107.040	Test bundle welding band each consisting of profile C pieces of 37 cm single marked 9× HDPE, 8× 2 mm white, 9× PP, 8× 2 mm natural, 9× ABS, 8× 2 mm white, 9× PC / PBTP / Xenoy grey	C		

Profile sizes

Profile A	Profile B	Profile C	Profile D

Dimensions in mm





Aldi logistics center 50000m2 TPO Membrane, Switzerland



Exploration Place First, Wichita, USA



Schöni transport Centre, Switzerland

Roofing

Roofing welders overview	40
UNIDRIVE 500	41 / 42
UNIROOF AT / ST	43 - 45
VARIMAT V2 / VARIMAT S	46 / 47
BITUMAT B2	48
EXAMO USB / Testing instrument	49

Hot Air Tools for Roofing

TRIAC ST	12 – 15
TRIAC AT	13 – 15
ELECTRON ST	16 / 17
HOT JET S	18 / 19
General accessories	36 / 37







Simple operation in combination with high welding performance.



Flameless welding of modified bitumen with the BITUMAT. B2.

Overview Roofing Welders

				
Materials	Thermoplastic Single-Ply membranes			Modified Bitumen
Type of welding machine	UNIDRIVE 500	UNIROOF AT/ST	VARIMAT V2 / VARIMAT S	BITUMAT B2
Main application	Parapets, tight spaces, pitched roofs	Parapets, edges Residential construction surfaces under 500 m2	Welding close to edges Industrial surfaces over 500 m2	First bitumen layer
Roof construction				
Flat roof	✓✓✓	✓✓✓	✓✓✓	✓✓✓
Sloped roof	✓✓✓	✓✓	✓	✓
Basic weld seams	✓	✓✓	✓✓✓	✓✓✓
Detail work	✓✓✓	✓✓✓	✓	✓
Thickness of sealing sheets	up to 1.8 mm	up to 1.8 mm	up to 2 mm / 1.8 mm	up to 6 mm
Special features	Welding on both sides with rotating nozzle	Ideal for roof edge welding	Double welding performance against competitors	Flameless welding
Parapet spacing in mm	45	100	110	200
Generator operation	4KW	At least 6 kW to supply a hot air hand tool	At least 10 kW to supply a hot air hand tool	
Electronics				
Regulated for drive and heater (closed-loop system)	UNIDRIVE 500	UNIROOF AT	VARIMAT V2	
Controlled for drive and heater (open loop)		UNIROOF ST	VARIMAT S	BITUMAT B2
Speed m/min.				
Drive	0.7 – 4.5	1 – 10	0.7 – 12	0.8 – 12
Welding speed (depending on material)	1 – 2.5	2 – 3	4 – 8	3 – 6
Recommended welding start parameter depending type of membrane (tested by room condition 20°C)	PVC membrane: 2.0 m/min, 480 – 520°C, air volume 100% TPO/FPO membrane: 2.0 m/min, 420 – 470°C, air volume 100%	UNIROOF AT PVC: 2.0 m/min, 520°C, air volume 100% TPO: 2.5 m/min, 450°C, air volume 100% UNIROOF ST PVC: 1.8 m/min, 520°C, air volume 100% TPO: 2.0 m/min, 450°C, air volume 100%	VARIMAT V 2 PVC: 4.0 m/min, 550°C, air volume 85% TPO: 5.0 m/min., 500°C, air volume 100% VARIMAT S: PVC: Temperature level 8.5–9 (550°C) TPO: No trailing roller, can only be used to limited degree	nozzle till 100 mm Modified Bitumen: 5.0 m/min, 650°C, air volume 100%
Weight kg	4.5	17.5	35 / 28	40
Blower technology	Brushless	Brushless	Brushless / Brush motor	Brush motor
Catalog page	 41 / 42	43 - 45	46 / 47	48

✓✓✓ = Highly suitable, ✓✓ = Suitable, ✓ = Limited suitability

Reliable and cost-effective – everywhere – UNIDRIVE 500

The compact UNIDRIVE 500 semi-automatic hot-air welder impresses with its many advantages. Guided by two ergonomic handles, you can achieve the ideal pressure to ensure high-quality welding results. Change welding direction with ease via a rotating nozzle and reversible drive. The UNIDRIVE 500 is ideal for all roof applications, even in tight spaces, and welds two to three times faster than manual welding. Lap welding with the UNIDRIVE 500 – reliable and cost-effective – everywhere.

Semi-automatic hot-air welder

UNIDRIVE 500

1



Reliable:
Ergonomic handle for balanced pressure during manual welding

2



Safe:
Constant parameters and reliable quality – even with undervoltage

3



Flexible: Stainless steel nozzle for all welding application

4



Customized: Reversible drive allows for welding in either direction





Whether on or at the roof parapet or welding domed skylights, connections, or small terraces – the UNIDRIVE 500 shows its worth when space is tight.

Semi-automatic hot-air welder

UNIDRIVE 500











- **Safe:** Constant parameters and reliable quality – even with undervoltage
- **Fast:** Up to three times faster than manual welding
- **Customized:** Reversible drive allows for welding in either direction
- **Practical:** Compact and lightweight semi-automatic hot-air welder: 4.5 kg, 30 cm high
- **Economical:** Maintenance-free, brushless motors

Technical data		UNIDRIVE 500 100 V	UNIDRIVE 500 100 – 120 V	UNIDRIVE 500 220 – 240 V
Voltage	V~	100	120	230
Power	W	1500	1800	2200
Temperature	°C	100 – 560		
Air volume	%	45 – 100		
Speed	m/min	0.7 – 4.5		
Emission	L _{pA} (dB)	70 (K = 3 dB)		
Size (L × H × B)	mm	297 × 173 × 275		
Weight	kg	4.5		
Conformity mark		CE		
Protection class I		⊕		

Article No.:

163.144 UNIDRIVE 500, 40 mm, 220 – 240 V/2200 W, Euro plug, Silicone rollers
 163.146 UNIDRIVE 500, 40 mm, 220 – 240 V/2200 W, CEE 3 pol. blue, Silicone rollers
 163.148 UNIDRIVE 500, 40 mm, 100 – 120 V/1800 W, UK plug, Silicone rollers
 163.149 UNIDRIVE 500, 40 mm, 100 V/1500 W, JP plug, Silicone rollers
 163.150 UNIDRIVE 500, 30 mm, 220 – 240 V/2200 W, EU plug, Silicone rollers
 163.151 UNIDRIVE 500, 40 mm, 220 – 240 V/2200 W, CEE 3 pol. blue, Steel rollers
 163.152 UNIDRIVE 500, 15 mm, 220 – 240 V/2200 W, CEE 3 pol. blue, Steel rollers
 Included with purchase: Welding machine, device case, hex key, quick guide

Accessories UNIDRIVE 500

	164.586 15 mm 164.576 30 mm 164.403 40 mm	Overlap welding nozzle
	163.930	Pressure roller, steel 15 mm
	163.357	Pressure roller steel 40 mm
	162.551	Support wheel, silicone
	161.156	Silicone rubber roller 40 mm
	159.911	Wheel for silicon rubber roller 40 mm
	151.847	Brass brush
	164.605 156.531	Storage case UNIDRIVE 500 Carrying strap for Leister case
	145.582 165.176 165.179	Heating elements 230 V / 2200 W Heating elements 120 V / 2100 W Heating elements 100 V / 1600 W

UNIROOF AT/ST: Welding close to the edge made easy.

The new UNIROOF AT/ST roof welder is your flexible partner for welding thermoplastic roofing membranes on flat or pitched roofs (up to 30°). Thanks to its slim design and construction, as well as the movable transport axle, converting of the machine is no longer needed. Now, you can effortlessly weld close to the edge (to 100 mm) at the parapet or on the parapet and as easily in narrow circumstances.

Hot-air welder

UNIROOF AT/ST



No more time consuming converting: The ultra slim roof welding machine with its movable transport axle masters welding close to the edge (up to 100 mm) at or on the parapet, and wherever it gets narrow.



UNIROOF provides elaborate ergonomic handling thanks to steering bar and handle: Roll or carry the UNIROOF whenever, wherever you want to, it's so handy!



UNIROOF AT: The closed-loop technology for drive motor, temperature and air blower keeps the welding parameters at a constant level and thus delivers reliably leak proof results – a clear asset when it comes to process reliability and investment safety.



UNIROOF AT: Functional control panel with display for welding parameters (set point and actual figures during runtime) as well as voltage for better control. Save time with programmable welding profiles for common roof membranes.



UNIROOF ST for purists: Closed-loop controlled drive motor with open-loop technology for the control of temperature and air blower. Simple control (regulation) with potentiometer/rotary knobs.



Optimum overall performance and easy-to-operate: The direct-driven, maintenance-free pressure wheel [brushless drive motor integrated in pressure wheel] leads to higher contact pressure, welding speed and thus causes zero chain wear.

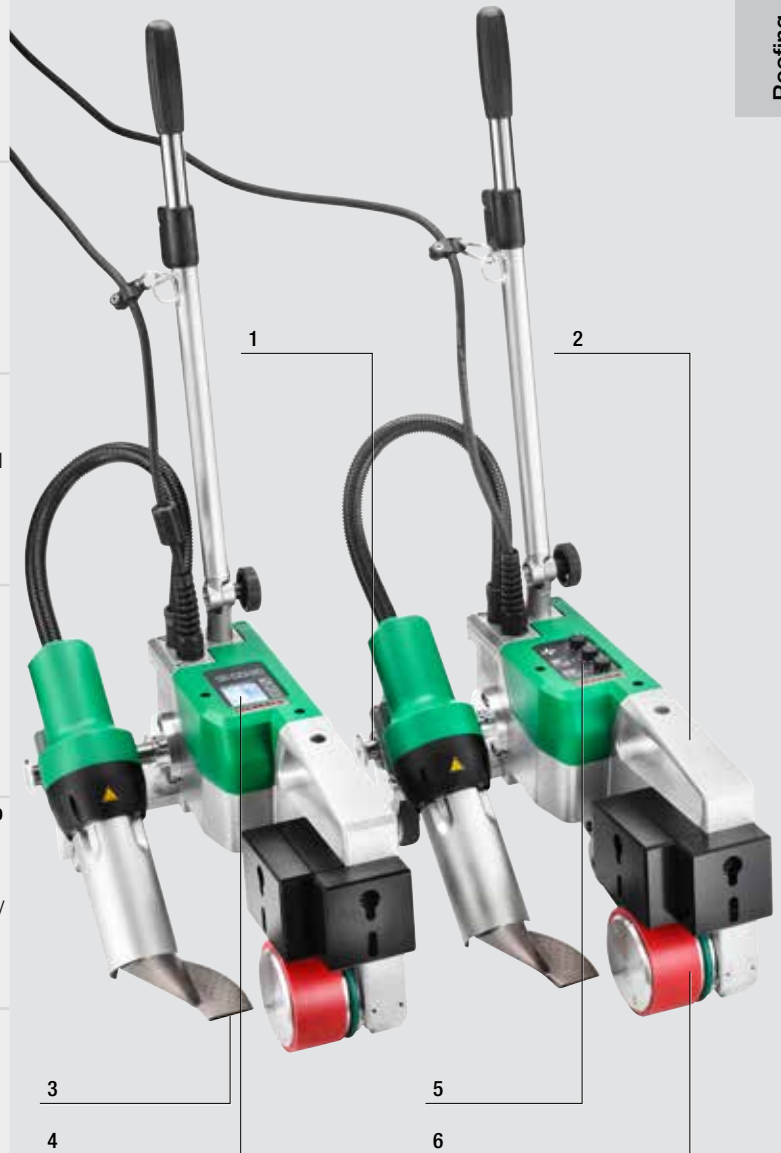

Roofing

With 3450 W performance, 230 V and 15 Amps in the box, the UNIROOF AT/ST offers speedy top performance on any roof.



Thanks to its ultra slim design, the UNIROOF welds effortlessly even in areas which are narrow and difficult to access.

Hot-air welder

UNIROOF AT



- No retooling, thanks to movable transportation axle
- Maintenance-free direct drive and closed-loop technology
- Ergonomic handling, flexible relocating and optimal machine guiding
- 66% higher welding performance compared to similar machines
- Welding roof structure profiles

Technical Data		UNIROOF AT
Voltage	V~	100 / 220 – 240
Frequenz	Hz	50 / 60
Power	W	1500 / 3450
Temperature, stepless	°C	100 – 620
Air flow range	%	45 – 100
Drive speed, stepless	m/min	1.0 – 10.0
Size (L × B × H)	mm	475 × 244 × 260
Weight	kg	17.5 (incl. 3 additional weights)
Materials		PP, PVC, TPO, ECB, EPDM, EVA, FPO, PO, PIB (other materials upon request)
Conformity mark		CE
Protection class I		⊕
Fan		maintenance-free
Operation		Digital with display
Temperature control		Closed-loop System
Article No.:		
153.598	UNIROOF AT, 220 – 240 V / 3450 W, 40 mm, with Euro-plug	
153.599	UNIROOF AT, 120 V / 1800 W, 40 mm (1.6 inch), with US-plug	
157.188	UNIROOF AT, 220 – 240 V / 3450 W, 30 mm, with Euro-plug	
166.368	UNIROOF AT, 220 – 240 V / 3450 W, 40 mm, mit Korea Stecker	

Hot-air welder

UNIROOF ST



- No retooling, thanks to movable transportation axle
- Maintenance-free direct drive and open-loop technology
- Ergonomic handling, flexible relocating and optimal machine guiding
- 38% higher welding performance compared to similar machines
- Welding roof structure profiles

Technical Data		UNIROOF ST
Voltage	V~	100 / 220 – 240
Frequenz	Hz	50 / 60
Power	W	1500 / 3450
Temperature, stepless	°C	100 – 620
Air flow range	%	45 – 100
Drive speed, stepless	m/min	1.0 – 10.0
Size (L × B × H)	mm	475 × 244 × 260
Weight	kg	17.5 (incl. 3 additional weights)
Materials		PP, PVC, TPO, ECB, EPDM, EVA, FPO, PO, PIB (other materials upon request)
Conformity mark		CE
Protection class I		⊕
Fan		brush motor
Operation		Potentiometer
Temperature control		Open-loop System
Article No.:		
153.600	UNIROOF ST, 220 – 240 V / 3450 W, 40 mm, with Euro-plug	
157.189	UNIROOF ST, 220 – 240 V / 3450 W, 30 mm, with Euro-plug	
153.601	UNIROOF ST, 120 V / 1800 W, 40 mm (1.6 inch), with US-plug	

Accessories UNIROOF AT/ST

	155.414 Roof structure profile kit
	155.325 Grip-nozzle 40 mm 149.597 spring plate
	152.742 Additional weight, front 1.5 kg 152.741 Additional weight, lateral 2.0 kg
	154.462 Nozzle calibration device
	132.429 Welding plate
	138.817 Steelbrush to clean nozzle
	154.522 Transportation axle 300 mm
	152.706 Transportation axle 220 mm for radius welding
	154.827 Storage case UNIROOF
	155.577 Locking plate for additional weights
	137.843 T-shape guide bar

	108.129 T-shape guide bar upper part
	156.446 UNIROOF AT/ST 80 mm bitumen kit
	155.473 Heating element 230 V / 3300 W 153.947 Heating element 120 V / 1800 W 154.231 Heating element 100 V / 1500 W 145.604 Heating element 120 V / 2300 W* * Suitable for undervoltage so that the temperature can be reached



versatile, easy to maintain, efficient.

VARIMAT V2: Fast and dependable.

Using the new VARIMAT V2, polymer roofing membranes can be welded more rapidly resulting in lower cost. Users appreciate its streamlined ergonomics and its ease of use. The clearly laid out operating unit's "e-Drive" allows for the control of all relevant weld parameters.



Highly reliable in application even at undervoltage.

Hot-air welder

VARIMAT V2



- Process reliability: Machine cuts out if undervoltage is too high
- Patented spherical roller compensates unevenness
- Guide bar for ergonomic handling
- Maintenance free blower means lower service costs
- User-friendly display with "e-Drive" (press and turn control) to recall preset and saved welding settings
- Constant drive with regulated electronics





Technical data

Voltage	V~	230 / 400
Power	W	3680 / 5700
Temperature	°C	100 – 600
Speed	m/min	0.7 – 12
Air flow range	%	50 – 100
Width of welding nozzle	mm	40
Size (L x W x H)	mm	640 x 430 x 330
Weight	kg	35
Conformity mark		CE
Protection class I		⊕

Article No.:

- 138.108 VARIMAT V2, 230 V / 3680 W, Euro plug, storage case
- 137.821 VARIMAT V2, 400 V / 5700 W, 16 A CEE-plug, storage case
- 141.572 VARIMAT V2, 230 V / 3680 W, with 80 mm nozzle for bitumen, Euro plug, device case
- 153.428 VARIMAT S, 230 V / 4600 W, Euro-plug
- 153.427 VARIMAT S, 400 V / 5700 W, CEE-plug

Accessories VARIMAT V2

1		Ergonomic Height and angle of guide-bar can be adjusted easily
2		Maintenance-free High performance and brushless blower motor, no brushes to change
3		Intuitive Protected design. Easy-to-view display with "e-drive" and easy-to-store welding settings
4		Weld seam control The green air dam belt keeps the hot air in the welded seam. High speed New welding nozzle with protected design for reliable welding quality
5		More stability The patented pressure roller smoothes out any unevenness

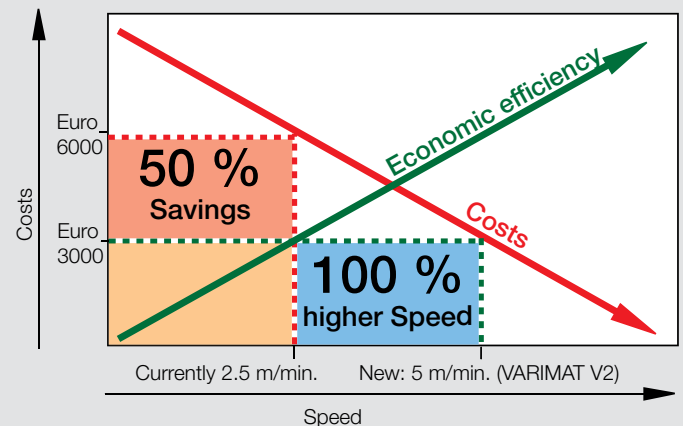



Welded with standard nozzle.



Welded with grip nozzle 25% higher weld seam strength. Mainly for TPO sealing sheets.

	113.995 Grip-nozzle 30 mm for TPO / FPO single plies
	113.600 Grip-nozzle 40 mm for TPO / FPO single plies
	110.805 20 mm overlap welding nozzle for thermoplastic sealing sheeting
	107.067 Additional weight for even more pressure
	139.048 Sturdy storage case 720 × 470 × 450 mm plywood, green included with purchase
	107.649 Replacement rolls
	132.429 Welding plate for optimum welding start included with purchase
	138.817 Steel brush to clean nozzle included with purchase
	146.514 Solar profile kit for Renolit
	143.162 Gentle pressure roller for difficult ground conditions
	119.111 Chuck cone for replacing silicone pressure roller
	151.530 Mirror welding kit, nozzle right, for special welding applications
	107.612 Heating elements 230 V / 4400 W
	107.613 400 V / 5500 W

	143.179 Complete set with rake nozzle, 40 mm, and pressure roller, soft 40 mm Rake nozzle to solve the problems caused by bubbles forming on hard surfaces.
	116.323 Rake nozzle, 40 mm
	143.163 Pressure roller, soft, 40 mm (silicone only)
	108.923 Welding unit bitumen-kit 80 mm, 230 V
	108.924 Welding unit bitumen-kit 100 mm, 230 V
	108.925 Welding unit bitumen-kit 120 mm, 230 V
	108.927 Welding unit bitumen-kit 100 mm, 400 V / 6100 W
	108.928 Welding unit bitumen-kit 120 mm, 400 V / 6100 W
	115.892 Welding unit bitumen-kit 80 mm, 400 V / 6100 W
	159.408 Nozzle positioning gauge VARIMAT V2

BITUMAT B2: The flameless.

Welding of modified bitumen sheeting (SBS, APP) with the flameless BITUMAT B2 is much safer than welding with an open flame. The weld strength is significantly better and the single step process makes welding more economical.



Easy unit guidance and clean working with the BITUMAT B2.

Hot-air welder

BITUMAT B2



- Flameless welding of modified bitumen
- No shrinking of the insulation due to integrated air dam
- Uniform welding results
- High working speed
- Requires only one user to efficiently weld seams (torch welding requires two)









Technical data

Voltage	V~	230 / 400
Power	W	6700 / 6700
Temperature	°C	20 – 650
Speed	m/min	0.8 – 12
Air flow range	%	85 – 100
Welding nozzle width	mm	75 / 100 / 120
Size (L x W x H)	mm	690 x 490 x 330
Weight	kg	40 (with cable)
Conformity mark		CE
Approval mark		Ⓢ
Protection class I		Ⓢ

Article No.:

- 140.438 BITUMAT B2 400 V / 6700 W, 75 mm, 16 A-CEE-plug
 - 140.437 BITUMAT B2 400 V / 6700 W, 100 mm, 16 A-CEE-plug
 - 140.436 BITUMAT B2 230 V / 6700 W, 75 mm, 32 A-CEE-plug
 - 138.386 BITUMAT B2 230 V / 6700 W, 100 mm, 32 A-CEE-plug
- Additional versions available upon request.

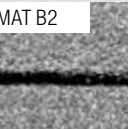
Accessories BITUMAT B2

	138.048	75 mm bitumen nozzle
	138.047	100 mm bitumen nozzle
	137.895	100 mm pressure roller with gap
	137.896	75 mm pressure roller with gap
	140.229	100 mm pressure roller without gap
	140.228	75 mm pressure roller without gap
	156.447	80 mm silicon pressure roller
	158.222	100 mm silicon pressure roller
	140.476	Lifting device
	155.328	BITUMAT B2 120 mm bitumen kit
	140.489	Sturdy storage case, 750 x 555 x 450 mm (included with purchase)
	126.594	Heating elements 400 V / 6500 W
	126.386	230 V / 6500 W

Considerably better welding results when compared with open flame tools. No damage to insulating material due to integrated air dam.

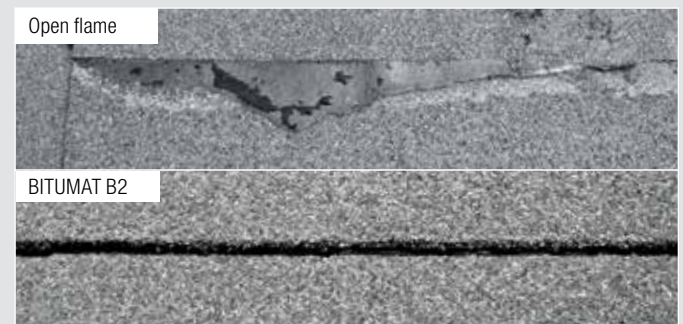

EXAMO: The inspector.

Is your seam sealed? Can it withstand the specified peel, tensile and shear forces? EXAMO performs tests at the construction site – quick, reliable and uncomplicated.



Testing a weld seam with the EXAMO USB.

Tensiometer

EXAMO 300F USB, 600F USB



- Construction-site approved
- Handy, robust and reliable
- Testing of elongation, peak force, tear force, test speed and position
- With jaws also suitable for geo textiles (see accessories)
- Electronic recording of the measurement data

Technical Data			
Type		300F USB	600F USB
Voltage	V~	230	230
Power	W	200	200
Tensile load	N	4000	4000
Jaw spacing	mm	5 – 300	5 – 600
Range	mm	300	600
Test speed	mm/min	20 – 550	20 – 550
Sample thickness	mm	max. 7	max. 7
Sample width	mm	max. 40 (60 optional)	max. 40 (60 optional)
Size (L x W x H)	mm	750 x 270 x 190 (case)	1050 x 270 x 190 (case)
Weight	kg	14	17.5
Conformity mark		CE	CE
Protection class I		⊕	⊕

Article No.:	
139.059	EXAMO 300F USB, 230 V / 200 W, incl. USB memory stick, Euro plug
139.060	EXAMO 600F USB, 230 V / 200 W, incl. USB memory stick, Euro plug

Accessories EXAMO 300F USB, 600F USB

	134.832	Testing and calibration kit to test and calibrate your EXAMO USB
	108.185	Jaw kit 60 mm for geotextiles including two pairs of jaws
	144.416	USB memory-stick

Leister offers a service to create a welding window. With new sealing sheets in particular, it is important to have the right starting parameters.

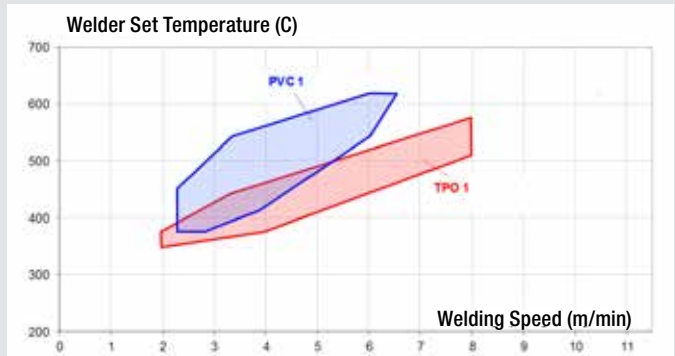

Typical welding windows for TPO and PVC



For testing T-joints

Article No.:	
153.026	VACUUM BELL Ø 320 mm
153.024	VACUUM PUMP 230V
153.025	VACUUM PUMP 120V



STER
HEMTEK ST
made in Switzerland





Truck cover



Awning



Flood protection

Technical Textiles & Industrial Fabrics

Product overview hot-air welders	52 / 53
HEMTEK ST	54 / 55
HEMTEK K-ST	56 / 57
SEAMTEK 900 AT	58 / 59 / 62
SEAMTEK W-900 AT	60 - 62
VARIANT T1	64 / 65
VARIANT T1 Overlap	65
VARIANT T1 TAPE	66
UNIPLAN 300 / 500	67 / 68
TAPEMAT / TAPEMAT SPRIEGEL	69

Hot-Air Hand Tools

TRIAK ST	12 – 15
TRIAK AT	13 – 15
HOT JET S	18 / 19
SOLANO AT	20 / 21
GHIBLI AW	22 / 23
General accessories	36 / 37



Billboard

Stationary welding machines

				
Device type	HEMTEK ST	HEMTEK K-ST	SEAMTEK 900 AT	SEAMTEK W-900 AT
Max. voltage V~	120 / 230	120 / 230	230 / 240	230 / 240
Max. power W	1800 / 2350 / 3450	1800 / 2350	4500	3900
Temperature °C	100 – 650	100 – 650	120 – 700	0 – 680
Speed m/min	0.8 – 12	0.8 – 12	0.1 – 30	0.8 – 30
Welding width mm	20 / 30 / 40	8	8 – 64	8 – 64
Size (L × W × H) mm	433 × 350 × 600	433 × 350 × 600	1500 × 702 × 1500	1700 × 702 × 1500
Weight kg	27.0	27.0	238.0	238.0
Welding options				
Overlap welding	✓		✓	✓
Hem welding	✓		✓	✓
Piping welding	✓	✓	✓	✓
Tape welding	✓		✓	✓
Prayer weld			✓	✓
Pole pocket	✓		✓	✓
Butt joint with tape			✓	✓
Welding technologies				
Hot-air welding	✓	✓	✓	
Hot-wedge welding				✓
Features				
Temperature regulation			✓	✓
Drive regulation			✓	✓
Temperature and drive infinitely adjustable	✓	✓	✓	✓
Digital display			✓	✓
Catalog page	 54 / 55	56 / 57	58 / 59 / 62	60 - 62



Tents

Product overview hot-air welders for Technical Textiles & Industrial Fabrics

							
Device type	VARIANT T1 Overlap	VARIANT T1 TAPE 50 mm	VARIANT T1 TAPE 25 mm	UNIPLAN 300	UNIPLAN 500	TAPEMAT 50 mm	TAPEMAT SPRIEGEL 100 / 125 mm
Max. voltage V~	230 / 400	230 / 400	230 / 400	120 / 230	120 / 230	3 × 400	3 × 400
Max. power W	3680 / 5700	3680 / 5700	3680 / 5700	1800 / 3450	1800 / 3450	10 000	10 000
Temperature °C	100 – 620	100 – 620	100 – 620	100 – 620	100 – 620	100 – 650	100 – 650
Speed m/min	1.5 – 18	1.5 – 18	1.5 – 18	1 – 16	1 – 16	4 – 20	4 – 20
Welding width mm	20 / 40	50	25	20 / 30 / 40	20 / 30 / 40	50	2 × 20
Size (L × W × H) mm	500 × 400 × 195	700 × 415 × 85	700 × 415 × 85	500 × 310 × 300	500 × 310 × 300	555 × 435 × 370	555 × 435 × 370
Weight kg	22.5	28.0	28.0	15.0	16.0	35.0	40.0
Conformity mark	CE	CE	CE	CE	CE	CE	CE
Certification scheme	CCA	CCA	CCA	CCA	CCA	CCA	CCA
Protection class	⊕	⊕	⊕	⊕	⊕	⊕	⊕
Welding options							
Overlap welding	✓			✓	✓		
Hem welding	✓			✓	✓		
Piping welding	✓			✓	✓		
Tape welding		✓	✓			✓	✓
Prayer weld	✓	✓	✓	✓	✓	✓	✓
Hem pipe	✓	✓	✓	✓	✓	✓	✓
Welding technologies							
Hot-air welding	✓	✓	✓	✓	✓	✓	✓
Hot-wedge welding							
Features							
Temperature regulation	✓	✓	✓	✓	✓		
Drive regulation	✓	✓	✓	✓	✓		
Temperature and drive infinitely adjustable	✓	✓	✓	✓	✓	✓	✓
Digital display	✓	✓	✓	✓	✓		
Catalog page	 64 / 65	65	66	67 / 68	67 / 68	69	69

HEMTEK ST: Hem Welding has never been so easy.

The HEMTEK ST is designed for a wide range of applications and is particularly intuitive to use. Once the machine is mounted, you can start welding immediately. Preparing or finishing with hot-air hand tools is no longer necessary. From now on, you can quickly weld promotional banners or tarpaulins from corner-to-corner with ease.

Hot-air Welding machine

HEMTEK ST

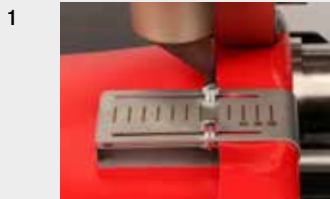

1 Hem guide:
Three applications possible with one hem guide: Hem (20/30/40 mm); Pole pocket up to 100 mm; Piping.



2 Table clamp:
The quick-clamp lock enables you to mount the machine quickly and easily onto almost any work table.



3 Control panel:
The intuitive control unit guarantees a stress-free welding experience. Temperature, speed and airflow can easily be adjusted. Integrated cooldown mode gently cools the machine.



4 Foot pedal:
The HEMTEK ST can be operated comfortably with the foot pedal so that both hands are free to guide the material.



5 Pressure roller:
Thanks to the integrated weight, pressure can be adjusted steplessly. The roller incorporates high contact pressure with an intelligent eccentric system. Various nozzle widths and rollers for specific applications are available.



Thanks to the foot pedal, both hands are free to guide the material. High weld quality and stress-free welding experience guaranteed.



Whether sitting or standing, the HEMTEK ST can be used at almost any work table.

Hot-air Welding machine

HEMTEK ST

- Welding speeds of up to 12 m per minute
- Very strong blower
- Tool-free setting of the hem guide
- One hem guide, three applications:
Hem: 20/30/40 mm; Pole pocket: up to 100 mm; Piping
- Easy-to-use: Thanks to the foot pedal, your hands are free to guide the material
- Everything in a single step: No need to weld with hot-air hand tools afterwards
- All welding parameters are adjustable
- Cooldown mode
- Can be mounted onto almost any table: freely adjustable quick-clamp lock

Technical data		120 V		230 V	
Voltage	V~	120	230	230	230
Frequency	Hz	50/60	50/60	50/60	50/60
Power	W	1800	3450	2350	2350
Temperature, stepless	°C	100 – 650			
Air quantity, stepless		1 – 10			
Drive, stepless	m/min	0.8 – 12			
Welding width	mm	20/30/40	30/40	20	
Emission	L _{pA} (dB)	70 (K = 3 dB)			
Size (L × W × H)	mm	433 × 350 × 600			
Weight	kg	27 (Including table mount)			
Conformity mark		CE	CE	CE	
Protection class I		⊕	⊕	⊕	

Included with purchase:

Hot-air welder, table mount, hem guide, scraper, silicone stopper, quick guide, general catalog, folder

Article No.:

- 157.862 HEMTEK ST, 230 V/2350 W, 20 mm, EU-plug
- 157.861 HEMTEK ST, 230 V/3450 W, 30 mm, EU-plug
- 157.860 HEMTEK ST, 230 V/3450 W, 40 mm, EU-plug
- 157.868 HEMTEK ST, 230 V/2350 W, 20 mm, UK-plug
- 157.867 HEMTEK ST, 230 V/3450 W, 30 mm, UK-plug
- 157.866 HEMTEK ST, 230 V/3450 W, 40 mm, UK-plug

Accessories HEMTEK ST

	157.048 20 mm 157.047 30 mm 108.117 40 mm
	157.070 20 mm 157.071 30 mm 161.202 40 mm
	157.707 20 mm 157.706 30 mm 157.705 40 mm
	157.098 Nozzle adjustment gauge
	156.472 Adjustable hemming/piping guide
	157.879 Adjustable hemming/piping guide for heavy materials
	155.800 Overlap guide
	159.780 Tape welding guide
	169.971 Tape delivery system
	160.269 Contact pressure weight large
	153.947 120V/1800W (20/30/40 mm) 149.675 230V/2200W (20 mm) 145.606 230V/3300W (30/40 mm)
	157.540 Rubber stoppers

HEMTEK K-ST: Piping creation made easy

Based on your individual needs, you can produce your own piping with the HEMTEK K-ST. Because the HEMTEK K-ST is extremely flexible, you can react even faster to specific customer inquiries. The easy-to-use, infinitely-adjustable guide enables process-reliable piping creation with different lug widths. The foot pedal means you have both hands free and can use them to guide the material. This allows you to concentrate fully on the welding process.

Hot-air welder

HEMTEK K-ST



Piping guide:
Process-secure, easy guidance of the piping cord up to 13mm for optimum results.



Control panel: The intuitive control unit guarantees a stress-free welding experience. The temperature and speed can be adjusted easily. The integrated cool-down mode gently cools the machine.



Table clamp:
The quick-clamp lock enables you to mount the machine quickly and easily onto any work table.



Foot pedal: The HEMTEK K-ST can be operated comfortably with the foot pedal so both hands are free to guide the material.





You can operate the HEMTEK K-ST at any work table – sitting or standing.

Hot-air welder

HEMTEK K-ST

- Piping creation made easy
- Lug width infinitely adjustable
- Piping diameter 3 – 13 mm
- Up to 12 m/min
- Quick and easy installation of the machine
- Thanks to the foot pedal, you can use both hands to guide the material and piping. High welding quality and a stress-free welding experience are guaranteed.

Technical Data		120 V	220 – 240 V
Voltage	V~	120	230
Frequency	Hz	50/60	50/60
Power	W	1800	2350
Temperature, stepless	°C	100 – 650	
Drive, stepless	m/min	0.8 – 12	
Welding seam width	mm	8	
Emission	L _{pA} (dB)	70 (K = 3 dB)	
Size (L × B × H)	mm	433 × 350 × 600	
Weight	kg	27 (including table fastening)	
Conformity mark		CE	CE
Protection class I		⊕	⊕

Scope of delivery:
Hot-air welder, table fastening console, flap piping guide, quick guide, main catalog, folder

Article no.
162.499 HEMTEK K-ST, 230 V / 2350 W, EU plug
162.605 HEMTEK K-ST, 120 V / 1800 W, US plug

Accessories

	163.796 Modification kit K-ST
	161.202 Pressure roller below 40 mm
	161.259 Flap-piping nozzle 8 mm
	163.798 Nozzle adjustment gauge
	160.749 Double flap-piping guide
	149.675 Heating element 230 V / 2200 W
	116.798 Brass brush

Piping kits for converting HEMTEK ST to HEMTEK K-ST

Existing	Required for HEMTEK K-ST (piping production)		
HEMTEK ST	Modification kit K-ST 163.796	Pressure roller below 161.202	Heating element 230 V / 2200 W 149.675
157.862 20 mm EU plug	•	•	
157.861 30 mm EU plug	•	•	•
157.860 40 mm EU plug	•	•	•
157.868 20 mm UK plug	•	•	
157.867 30 mm UK plug	•	•	•
157.866 40 mm UK plug	•	•	•
157.871 20 mm US plug	•	•	
157.870 30 mm US plug	•	•	
157.869 40 mm US plug	•		

SEAMTEK 900 AT: Maximum flexibility for your specific application

The intelligent construction of the SEAMTEK 900 AT makes practically any welding application possible. Thanks to the well-thought-out multi-arm system, the machine can be set to a specific configuration for the application in record time. The huge selection of various drive wheels, nozzles and guides guarantees maximum flexibility. The intuitive operation of the user interface takes place entirely via touchscreen and permits simple adjustment of the regulated parameters.

Welding machine

SEAMTEK 900 AT

1		<p>Intuitive</p> <ul style="list-style-type: none"> • All parameters can be modified via touchscreen • Complete regulation of all parameters
2		<p>Application-friendly</p> <ul style="list-style-type: none"> • Tool-free nozzle adjustment • Rapid wheel replacement
3		<p>Pedestal</p> <ul style="list-style-type: none"> • Overlap welding • Hem and piping welding • 3D / Inflatable welding • Tape welding
4		<p>Quickarm</p> <ul style="list-style-type: none"> • Endless welding of pipes and hoses • Overlap welding
5		<p>Sidearm</p> <ul style="list-style-type: none"> • Circumference welding • Tape welding • Sealing of end caps • Strip welding
6		<p>Tape Delivery System</p> <ul style="list-style-type: none"> • Application of seam sealing tape • Welding of reinforcement tape • Welding of hot melt adhesive tape



Leister SEAMTEK 900 AT

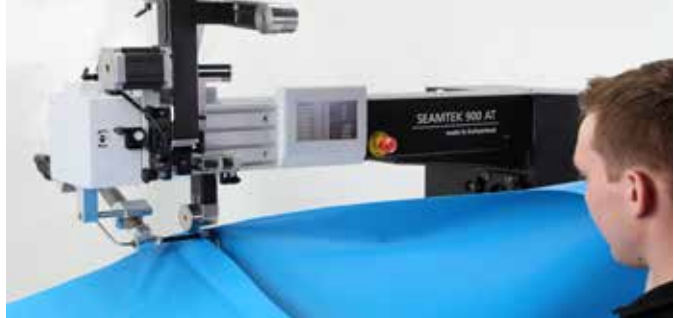

Easy, economical and safe welding.

Welding machine

SEAMTEK 900 AT



- Multi-arm system guarantees great flexibility
- Digitally regulated welding parameters
- Intuitive user interface
- Quiet operation
- Test mode for rapid parameter determination
- Drive wheels and guides can be quickly changed
- Maintenance-free and durable





Technical data

Voltage	V~	230 / 240
Power	W	4500
Temperature	°C	120 – 700
Speed		0.1 – 30
Size (L × W × H)	mm	1500 × 702 × 1500
Weight	kg	238 kg Base 268 kg Fully loaded
Required air pressure	bar	6.2
Welding seam width	mm	8 – 64

Article No.:

155.555	SEAMTEK 900 AT Base version with pedestal, 2 steel pressure rollers 25 mm, standard nozzle 25 mm
155.777	Quick arm
155.666	Side arm
155.888	Tape Delivery System (TDS)
155.386	Monitoring unit for the SEAMTEK 900 AT

Accessories SEAMTEK 900 AT

	Wheel, Steel, Ø 63.5 mm 155.392 8 mm 155.393 13 mm 155.863 19 mm 154.593 25 mm 155.864 38 mm 155.394 50 mm 155.865 57 mm 154.619 64 mm
	SEAMTEK Nozzle 157.808 8 mm (Low Flow) 157.799 13 mm (Low Flow) 151.598 13 mm 151.601 19 mm 151.597 25 mm 151.608 38 mm 151.599 50 mm 151.850 55 mm 151.600 64 mm
	152.941 Closing nozzle with angle
	152.956 Hem nozzle



SEAMTEK 2000 AT (2 m frame). Delivery time on request.

SEAMTEK W-900 AT: Variable speed for maximum efficiency

The SEAMTEK W-900 AT is the first welding machine to feature the innovative hot-wedge technology from LEISTER. This new welding machine is based on the tested and trusted SEAMTEK 900 AT. It allows you to easily reduce the welding speed without interruption during critical points in the welding process, while maintaining the same level of seam quality. Discover the benefits of the SEAMTEK W-900 AT and boost your welding efficiency.

Welding machine

SEAMTEK W-900 AT

1		Innovation <ul style="list-style-type: none">• The speed can be changed during the welding process, just like when using a sewing machine• Temperature is automatically adjusted to your speed• Highly efficient, up to 680 °C
2		Significant potential for savings <ul style="list-style-type: none">• Virtually no energy consumption in standby mode• Significantly lower energy consumption than comparable machines• Inexpensive replacement wedges
3		Ready for use in just a few seconds <ul style="list-style-type: none">• No preheating required• Hot wedge heats up immediately at the start of the welding process
4		Safe and easy <ul style="list-style-type: none">• Reduce the speed easily during the welding process without affecting the seam quality• The hot wedge cools down as soon as it is swiveled out (or in standby mode). This reduces the risk of burns
5		Outstanding seam results <ul style="list-style-type: none">• Flat, precise seams, even when welding curves• Better welding results with fewer waves and wrinkles in the case of delicate materials



LEISTER SEAMTEK W-900 AT



Dinghies © Marek Uliasz | Dreamstime.com



Innovative hot-wedge technology

Welding machine

SEAMTEK W-900 AT



- Easy to change wedge bracket
- Multi-arm system with pedestal and quickarm
- Welding parameters digitally regulated
- Intuitive user interface
- Practically silent
- Compressed air connection not required
- Welding parameters can be saved
- Virtually no smoke
- Low-maintenance
- Digital wizard to adjust the wedge position





Technical data

Voltage	V~	230 / 240
Power	W	3900
Temperature	°C	0 – 680
Speed	m/min	0.8 – 30
Dimensions (L × B × H)	mm	1700 × 702 × 1500
Weight	kg	238
Welding seam width	mm	8 – 64

Article No.:

159.159	SEAMTEK W-900 AT with pedestal and a power supply (without wheels and wedge bracket)
160.330	Additional power supply
155.777	Quickarm
155.888	Tape delivery system

SEAMTEK W-900 AT accessories

	Wedge bracket for 3D applications
162.854	8 mm
162.847	13 mm
162.846	19 mm
162.700	25 mm
162.809	38 mm
162.818	50 mm
162.829	57 mm
162.837	64 mm
	Wedge bracket for high-speed applications
163.172	8 mm
163.173	13 mm
163.174	19 mm
163.175	25 mm
163.176	38 mm
163.177	50 mm
163.178	57 mm
163.179	64 mm
	3D wedge package 5 piece
163.419	8 mm
163.420	13 mm
163.421	19 mm
163.422	25 mm
163.423	38 mm
163.424	50 mm
163.425	57 mm
163.426	64 mm
	High-speed wedge package 5 Stk.
163.427	8 mm
163.428	13 mm
163.429	19 mm
163.430	25 mm
163.431	38 mm
163.432	50 mm
163.433	57 mm
163.434	64 mm



Aircraft hangar / angarstroy.com

Accessories SEAMTEK 900 AT / SEAMTEK W-900 AT

	<p>Wheel, Silicone, 50A, Ø 63.5 mm</p> <p>155.401 13 mm 155.402 19 mm 155.403 25 mm 155.404 38 mm 155.405 50 mm 155.406 57 mm 155.407 64 mm</p>		<p>155.400 Holder system for guides</p>
	<p>155.660 Adjustable overlap guide, 0 – 64 mm</p>		<p>156.780 Overlap guide for quick arm</p>
	<p>155.530 Adjustable hem-/ piping guide 0 – 50 mm</p>		<p>155.410 Connection adapter for fume extraction</p>
	<p>155.760 Adjustable hem-/ piping guide 0 – 60 mm, for heavy materials</p>		<p>158.789 Tape cutting unit 18 – 25 mm (Compressed air needed)</p>
	<p>155.380 Open Hem/Pocket Guide up to 110 mm</p>		<p>158.928 Puller unit (Compressed air needed)</p>
	<p>155.540 Modular 3D guide</p>		<p>159.389 Adjustable Pedestal table</p>
	<p>156.760 Overlap guide from the left</p>		<p>158.139 LED gooseneck work lamp</p>
	<p>156.770 Adjustable acrylic tape guide</p>		



VARIANT T1: Quality, productivity, ergonomic.

The robust VARIANT T1 is very versatile. It is used in various applications for hem, overlap and tape welding. VARIANT T1 convinces with its high working speed, particularly with vehicle tarpaulin production for welding lap, reinforcement and anti-vandalism tapes. Thanks to the “e-Drive” operating concept, setting the relevant welding parameters could not be easier.

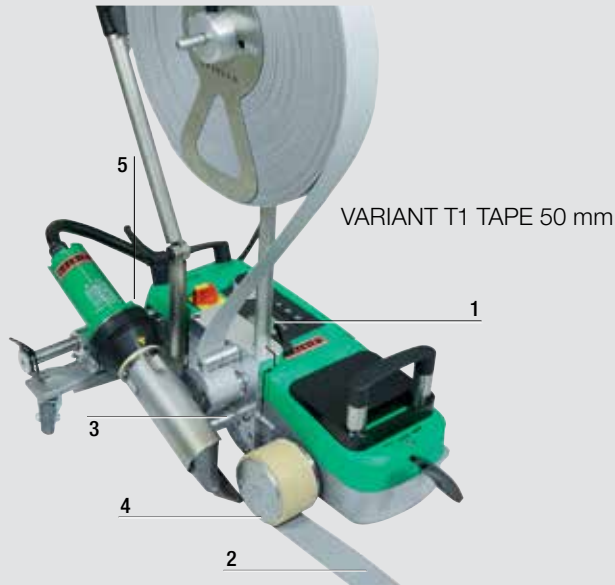

VARIANT T1 TAPE 50 mm

VARIANT T1

1		<p>Economical: Up to 18 m/min welding speed and powerful, maintenance-free hot air blower.</p>
2		<p>Reliable: Constant, wrinkle-free welds thanks to process-optimised nozzle.</p>
3		<p>Hem- / piping welding kit: Welding hems, hem pockets and piping in short time with easy-to-use accessories.</p>

VARIANT T1 TAPE

1		<p>User-friendly: Clear display plus "e-Drive" and storable welding parameters.</p>
2		<p>Highly flexible: Conversion kits make it possible to work with different types of tape: 50 mm reinforcement and 25 mm anti-vandalism tapes (see image).</p>
3		<p>Feeding to perfection: The new guide rollers make it easy to position the material and keep it taut right up to the final centimeter.</p>
4		<p>Dual-action: The pressure roller can easily be converted from a 50 mm width to a 25 mm one (anti-vandalism tape) or vice versa.</p>
5		<p>Optional: The laser guide keeps the VARIANT T1 TAPE firmly on course.</p>

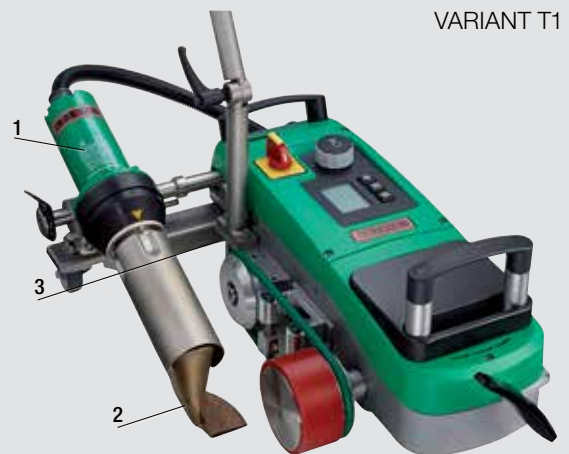

VARIANT T1

VARIANT T1: Compact, fast and reliable.

This tool's top welding speed of up to 18 m/min and its slim, compact design make it a winning choice.



Very easy hem and piping welds with the hem / piping welding kit.

Hot-air welder

VARIANT T1 Overlap



- Top welding speed up to 18m/min
- Perfect view into the weld seam
- Sturdy and durable for professional use
- Smooth lifting device for precise positioning
- Simple operation due to "e-Drive" operating concept

Technical data

Voltage	V~	230 / 400 (3LNPE)
Power	W	3680 / 5700
Temperature	°C	100 – 620
Speed	m/min	1.5 – 18
Air flow range	%	40 – 100
Welding seam width	mm	20 or 40
Size (L × W × H)	mm	500 × 400 × 195
Weight	kg	22 (without 1.5 m cord)
Conformity mark		CE
Protection class I		⊕

Article No.:

141.891	VARIANT T1, 230 V / 3680 W, 40 mm nozzle, with Euro plug
141.892	VARIANT T1, 230 V / 3680 W, 20 mm nozzle, with Euro plug
141.893	VARIANT T1, 400 V / 5700 W, 40 mm nozzle, with CEE plug (3LNPE)
141.894	VARIANT T1, 400 V / 5700 W, 20 mm nozzle, with CEE plug (3LNPE)
156.145	VARIANT T1, 230 V / 3680 W, 40 mm, nozzle, with CEE 3-16 plug

Additional versions available upon request.

Accessories VARIANT T1 Overlap

	142.650	Hem / piping welding kit complete, comprising:
	142.221	Hold-down device
	141.326	Piping roll
	140.530	Hem / piping add-on part
	168.446	Adapter profile 50mm hem guide
	148.961	Conversion kit, VARIANT T1 Overlap to VARIANT T1 TAPE 25 mm
	148.962	Conversion kit, VARIANT T1 Overlap to VARIANT T1 TAPE 50 mm
	160.850	Weight bracket complete
	161.297	Overlap kit 50 mm
	159.899	Impeller adjustable
	139.438	Additional weight 3 kg
	116.798	Brass brush
	140.771	Overlap welding nozzle 20 mm
	141.558	Overlap welding nozzle 40 mm
	140.429	25 mm pressure roller complete
	138.938	45 mm pressure roller complete
	142.705	Sturdy storage case
	107.612	Heating elements 230 V
	107.613	400 V



An economical, ergonomic tool for welding reinforcement tapes.

Tape hot-air welder

VARIANT T1 TAPE



VARIANT T1 TAPE 25 mm, anti-vandalism

- Fastest, most precise automatic tape welding tool (up to 18 m/min)
- "e-Drive" operating unit
- Easy to use
- Taut tape guidance
- Kits for converting VARIANT T1 Overlap to 25 or 50 mm TAPE

Technical data





Voltage	V~	230 / 400
Power	W	3680 / 5700
Temperature	°C	100 – 620
Air flow range	%	50 – 100
Speed	m/min	1.5 – 18
Welding seam width	mm	50 oder 25
Size (L x W x H)	mm	700 x 415 x 85
Weight	kg	28 (with 3 m cord)
Conformity mark	CE	
Protection class I	⊕	

Article No.:

148.963	VARIANT T1 TAPE 25	mm, 230 V / 3680 W, with Euro plug
148.964	VARIANT T1 TAPE 50	mm, 230 V / 3680 W, with Euro plug
148.965	VARIANT T1 TAPE 25	mm, 400 V / 5700 W, with CEE plug (3LNPE)
148.966	VARIANT T1 TAPE 50	mm, 400 V / 5700 W, CEE plug (3LNPE)

Additional versions available upon request.

Accessories VARIANT T1 TAPE

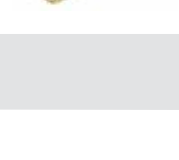
	149.652	Conversion kit VARIANT T1 TAPE 25 mm to VARIANT T1 TAPE 50 mm: 1 nozzle, 4 guide rollers, 1 gauge
	149.653	Conversion kit VARIANT T1 TAPE 50 mm to VARIANT T1 TAPE 25 mm: 1 nozzle, 4 guide rollers, 1 gauge
	149.654	Conversion kit VARIANT T1 TAPE to VARIANT T1 Overlap 20 mm
	149.655	Conversion kit VARIANT T1 TAPE to VARIANT T1 Overlap 40 mm
	149.100	Magnetic tool holder
	149.344	Laser guide
	139.438	Additional weight 3 kg
	116.798	Brass brush
	160.189	Anti-vandal tape 150 m
	107.612 107.613	Heating elements 230 V 400 V

Automatic, practical, safe – UNIPLAN 300 / UNIPLAN 500

Whether you are welding truck tarpaulins, tents, or banners, the UNIPLAN 300 and UNIPLAN 500 automatic welders are the ideal choice. Integrated lifting of the tarpaulins and automatic swiveling-in of the nozzle make the work easier for you and increases reliability. Thanks to the moveable swivel castor wheel, it is easy to get around obstacles such as grommets, hooks, or other accessories. Automatic, practical, safe – UNIPLAN 300 / UNIPLAN 500.

Hot-air welder

UNIPLAN 300 / UNIPLAN 500



automatic and safe:
swiveling in of the nozzle



practical:
integrated lifting of the tarpaulin



quick modification:
users can change from overlap welding to hem or pipe welding in one, easy step

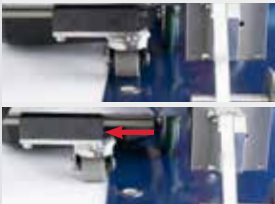

moveable swivel castor wheel:
to avoid obstacles such as grommets and hooks



reliable:
controlled temperature and speed



Technical Textiles and Industrial Fabrics



UNIPLAN 300/UNIPLAN 500: ideal for lap, hem, and piping welding either on a table or on the ground.

Hot-air welder

UNIPLAN 300 / UNIPLAN 500



UNIPLAN 300



UNIPLAN 500

- Blower motor with brushes
- Hot-air blower welding capacity of 12,500 rpm
- Display for setting the welding parameters
- Low-maintenance, brushless motor
- Hot-air blower for higher welding capacity of 18,000 rpm
- Display for setting and saving the welding parameters

Technical data		UNIPLAN 300		UNIPLAN 500	
Voltage	V~	120	230	120	230
Frequency	Hz	50 / 60			
Power	W	1800	3450	1800	3450
Temperature, stepless	°C	100 – 620			
Drive, stepless	m/min	1 – 16			
Nozzle width	mm	20 / 30 / 40			
Blower speed	rpm	12'500		18'000	
Blower motor		brushed		brushless (maintenance-free)	
Emission level	LpA (dB)	70 (K = 3 dB)			
Size (L x W x H)	mm	500 x 310 x 300			
Weight (without cable)	kg	15		16	
Conformity marking		CE			
Protection class I		⊕			

Article No.:	40 mm	30 mm	20 mm
UNIPLAN 300, 230 V, with EU plug	164.545	164.546	164.547
UNIPLAN 300, 230 V, with UK plug	164.551	164.552	164.553
UNIPLAN 300, 120 V, with US plug	164.557	164.558	164.559
UNIPLAN 500, 230 V, with EU plug	164.548	164.549	164.550
UNIPLAN 500, 230 V, with UK plug	164.554	164.555	164.556
UNIPLAN 500, 120 V, with US plug	164.560	164.561	164.562

Included with purchase:

UNIPLAN 300: Automatic welder, overlap guide, quick guide, transportation box
 UNIPLAN 500: Automatic welder, overlap guide, hem guide, material lifting device, 2 weights (1.25 kg each), weight holder base, weight holder extension, brass brush, short handle, nozzle adjustment gauge, quick guide, transportation box

Accessories UNIPLAN 300 / UNIPLAN 500

	165.083 Pressure roller kit 20 mm
	165.403 Pressure roller kit 30 mm
	165.082 Pressure roller kit 40 mm
	164.315 Nozzle 20 mm
	164.314 Nozzle 30 mm
	160.421 Nozzle 40 mm
	166.187 Hem guide
	165.791 Nozzle adjustment gauge
	160.351 Additional weight 1.25kg
	164.497 Weight holder base
	164.498 Weight holder extension
	157.000 Material lifting device
	163.878 Swivel castor wheel
	165.542 Handle console
	159.000 Long handle
	165.562 Short handle
	155.473 Heating element 230 V
	145.604 Heating element 120 V
	166.550 Piping kit 20 mm
	165.600 Piping kit 30 mm
	165.400 Piping kit 40 mm
	159.900 Piping pressure roller 20 mm
	165.500 Piping pressure roller 30 mm
	161.100 Piping pressure roller 40 mm
	169.082 Hold-down device

TAPEMAT: The power pack.

For rapid, economical strip welding of truck covers and industrial curtains. Very fast strip welder at up to 20 meters per minute.



Welding tape at maximum speed.

Tape hot-air welder

TAPEMAT



- High welding speed
- Process-optimized nozzle
- Maintenance-free, brushless blower
- Intuitive operation and simple handling

Spiegel hot-air welder

TAPEMAT SPIEGEL



- Top welding speed
- Process-optimized, high-precision nozzle
- Maintenance-free, brushless blower
- Easy to exchange counter-pressure roller
- Constant tarpaulin bow tension

Technical Textiles and Industrial Fabrics

Accessories

TAPEMAT / TAPEMAT SPIEGEL

Technical data		TAPEMAT	TAPEMAT SPIEGEL
Voltage	V~	3 × 400	3 × 400
Power	kW	10	10
Temperature	°C	~ 650	~ 650
Speed	m/min	4 – 20	4 – 20
Welding seam width	mm	50	100 / 125
Size (L × W × H)	mm	555 × 435 × 370	555 × 435 × 370
Weight	kg	35	40
Conformity mark		CE	CE
Approval mark		Ⓢ	Ⓢ
Protection class I		Ⓢ	Ⓢ

Article No.:

- 129.757 TAPEMAT 50 mm, 400 V / 10 kW, with 16A CEE plug
 138.229 TAPEMAT Spiegel 100 mm, 400 V / 10 kW, with 16A CEE plug
 133.597 TAPEMAT Spiegel 125 mm, 400 V / 10 kW, with 16A CEE plug

	138.242	Lifting device
	131.690	TAPEMAT 50 mm welding nozzle
	137.412	TAPEMAT SPIEGEL 100 mm welding nozzle, complete weld seam 20 mm left and right
	135.392	125 mm welding nozzle, complete weld seam 20 mm left and right
	101.991	3 × 400 V / 3 × 3300 W heating element

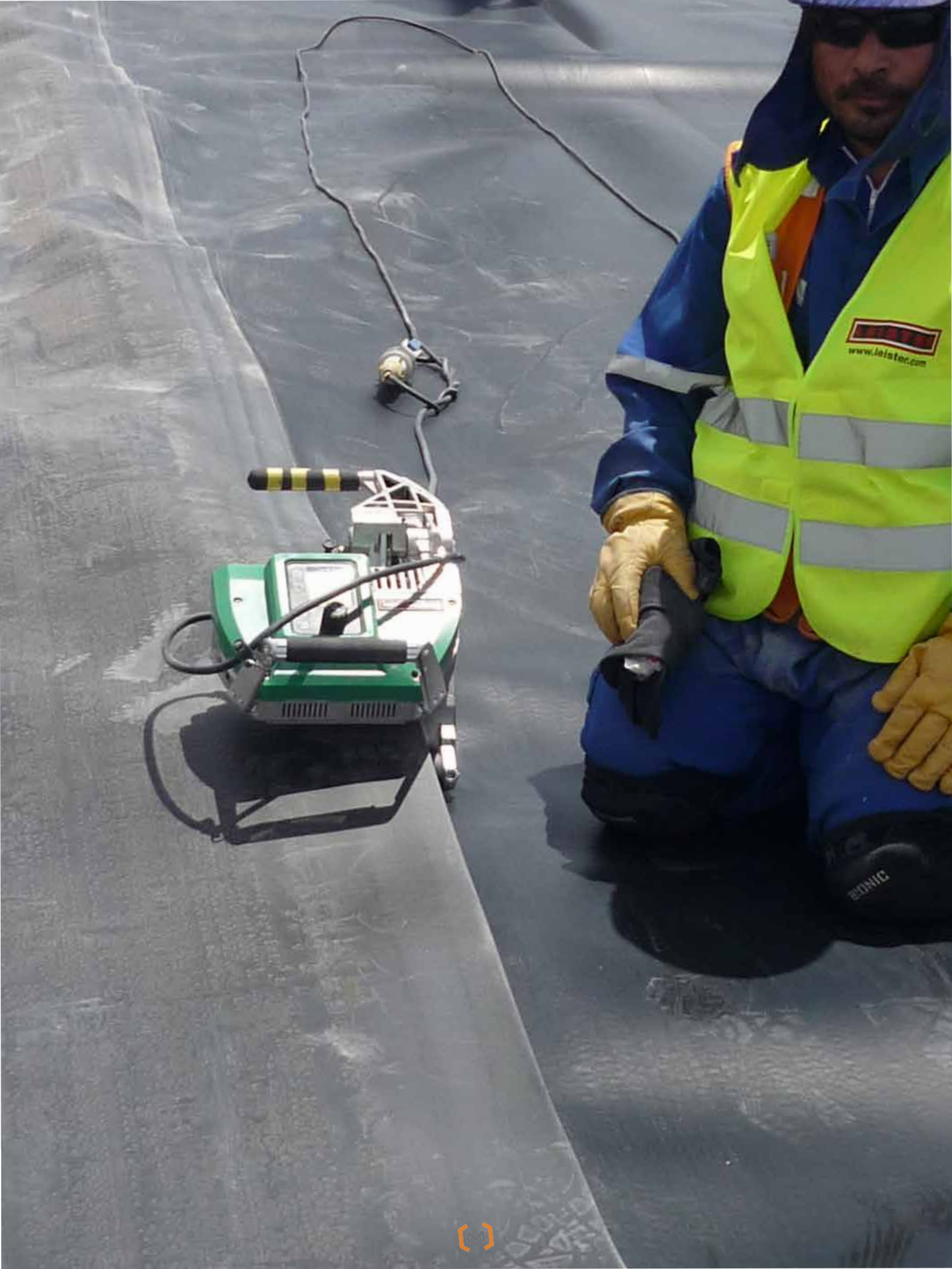



Shrimp Farm HDPE 0.5 mm



Tunnel PVC 2.5 mm



Water Reservoir HDPE 2.0 mm

Civil Engineering / Tunneling / Landfills

Product overview wedge welder	72
Product overview extrusion welder	73
GEOSTAR G7 / GEOSTAR G5	74 / 75
GEOSTAR G7 LQS / GEOSTAR G5 LQS	74 / 75
LQS - Leister Quality System	76 / 77
COMET / COMET USB	78 / 79
TWINNY T7 / TWINNY T5	80 / 81
TWINNY S	82
UNIDRIVE 500	83
WELDPLAST S6	84
WELDPLAST S4	85
WELDPLAST S2 / S2 TPO	86
FUSION 3 / FUSION 3C	87 / 88
EXAMO F300 USB / F600 USB	89
Vacuum test system	90
Compressed air testing system	91

Hot Air Tools

TRIAC ST	12 – 15
TRIAC AT	13 – 15
ELECTRON ST	16 / 17
General accessories	36 / 37

Possibilities of welding seams



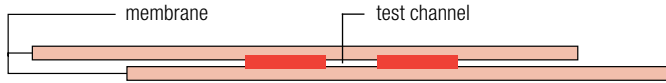

Overlap seam with test channel



Overlap seam without test channel



Product overview wedge welders for Civil Engineering / Tunnelling / Landfills

							
Device type	GEOSTAR G7 / G7 LQS	GEOSTAR G5 / G5 LQS	COMET / COMET USB	TWINNY T7	TWINNY T5	TWINNY S	UNIDRIVE 500
Voltage V~	230	120 / 230	120 / 230	230	120 / 230	120 / 230	120 / 230
Max. Power W	2800	1800 / 2800	1800 / 1500 / 1200	3450	1800 / 3450	1900 / 2900	2300
Temperature °C	80 – 460	80 – 460	80 – 420	560	560	80 – 600	20 – 600
Speed m/min	0.8 – 12	0.8 – 12	0.8 – 3.2	0.8 – 8	0.8 – 8	0.2 – 2.5 (4.0/6.0 ¹)	0.5 – 5
Max. Welding pressure N	1500	1500	1000	1000	1000	1000 (500)	
Weld seam width mm	2 × 15	2 × 15	2 × 15	2 × 15	2 × 15	2 × 15	15 / 30 / 40
Max. overlap mm	150	150	125	125	125	125	
Data recording	- / ✓	- / ✓	- / ✓	- / ✓			
Digital display	✓	✓	✓	✓			
Size (L × W × H) mm	482 × 278 × 269	482 × 278 × 269	295 × 250 × 245	323 × 360 × 259	323 × 360 × 259	350 × 390 × 270	297 × 173 × 275
Weight kg	17.7	16.4	7.5	10.5	9.9	6.5 – 6.9	4
Conformity mark	CE	CE	CE	CE	CE	CE	CE
Protection class	⊕	⊕	⊕	⊕	⊕	⊕	⊕
Welding technologies							
Hot-wedge welding	✓	✓	✓				
Combi-wedge welding				✓	✓	✓	✓
Applications							
HDPE, LDPE, TPO, FPO, PP	1.0 – 3.0 mm	0.8 – 3.0 mm	0.5 – 2.5 mm	0.5 – 2.5 mm	0.5 – 2.5 mm	0.5 – 2.5 mm	0.5 – 2.5 mm
PVC, CSPE, EIA	-	0.8 – 3.0 mm *(steel wedge only)	0.5 – 3.0 mm *(steel wedge only)	-	-	0.5 – 3.0 mm	-
Catalog page	 74 / 75	74 / 75	78 / 79	80 / 81	80 / 81	82	83

¹ For details, see page 82

Attention these are Leister recommendations only, depending upon material specifications the possible min. thicknesses may vary. For more information please contact your Leister Distributor.

* Please note PVC, CSPE and all Chlorinated products are only to be welded with steel wedges.



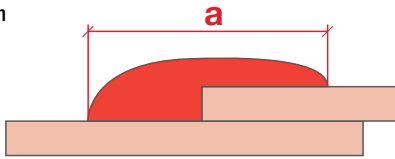

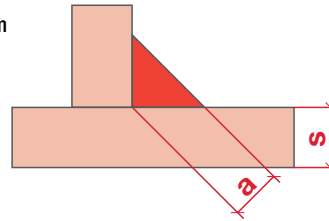

Overlap seam



Fillet welding seam



Product comparison

	Digitally regulated extrusion welders			Air heated extrusion welders	
					
Device type	WELDPLAST S6	WELDPLAST S4	WELDPLAST S2	FUSION 3	FUSION 3C
Output (HDPE) kg/hr	3.9 – 6	1.5 – 4	0.6 – 2.3	1.8 – 3.6	1.8 – 3.6
Material	HD-PE, PP	HD-PE, PP	HD-PE, PP, PVC	HD-PE, PP	HD-PE, PP
Wall thickness mm	15 – 40	8 – 35	4 – 20	8 – 25	8 – 25
Welding rod Ø mm	4 – 5	3 – 4 / 4 – 5	3 – 4	3 – 4 / 4 – 5	3 – 4 / 4 – 5
Weight kg	14	8.7	5.8	7.2	6.9
Length mm	821	560	450	690	588
Voltage V~	230	230	230	230	230
Screw extruder	yes	yes	yes	yes	yes
Container construction	✓✓	✓✓	✓✓	✓✓	✓✓
Pipeline construction	✓✓	✓✓	✓✓	✓✓	✓✓
Landfills / civil engineering	✓✓	✓✓	✓	✓✓	✓
Brushless blower	yes	yes	yes	no	no
Remarks	1	1	1	2	2
Catalog page	 84	85	86	87 / 88	87 / 88

✓✓ very suitable ✓ suitable

1: Air and plast temperatures are shown via a display and can be separately and freely adjusted.
 2: The air temperature is adjusted by means of a potentiometer (rotary dial). The heating of the plastic mass is performed by the pre-heating air.

Civil Engineering /
GEO

Overview of Extrusion Welders Output (kg/hr)

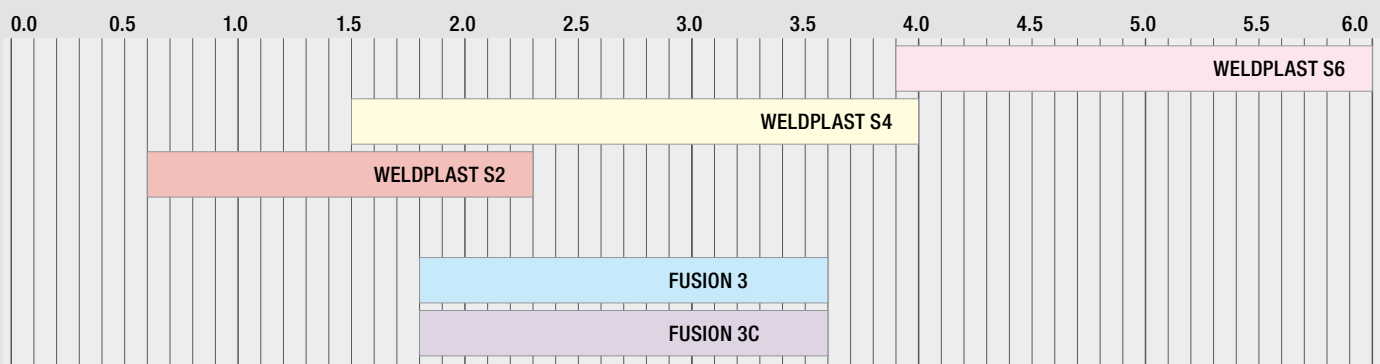

GEOSTAR G5 and GEOSTAR G7 – Faster, lighter, smarter

Wedge welding redefined: Leister's new GEOSTAR welders change the civil engineering landscape. This mid-size, lightweight welder boasts a robust, cast aluminum frame for quality welding of geomembranes. The GEOSTAR also features a unique digital display with all key weld parameters: heat, speed, pressure and supply voltage. The new design makes field servicing a cinch—wedge can be removed and replaced in under a minute. include: easy loading

Wedge welders

GEOSTAR G7 / G7 LQS, G5 / G5 LQS



- Welding speed up to 12 m/min
- G7 Longer wedge allows for welding up to 45% faster than the G5
- High heating capacity / heating power
- Digital display of weld pressure
- Integrated voltage display
- Wedge replacement in less than one minute
- Adjustable chassis height

Technical data		GEOSTAR G7 / G7 LQS
Voltage	V~	220 – 240
Frequency	Hz	50 / 60
Power	W	2800
Max. heating temperature	°C	460
Welding wedge	mm	130 × 50
Max. overlap	mm	150
Max. welding force	N	1500
Weld width with test channel	mm	2 × 15
Drive speed*1	m/min	0.8–12 Level 1: 0.8–7 Level 2: 1.5–12
Dimensions (L × W × H)	mm	482 × 278 × 269
Weight	kg	17.7
Materials		HD-PE 1.0–3.0 mm PP, LD-PE, TPO, FPO additional materials upon request
Mark of conformity		CE
Protection Class I		⊕

*1: Conversion of gear 1–2 using position change of sprocket wheels

Article No.

- 151.035 GEOSTAR G7, 230V / 2800W, Roller width 50 mm, copper wedge with test channel, with Euro plug
155.152 GEOSTAR G7 LQS data recording, 230 V / 2800 W, copper wedge with test channel, with Euro plug

Scope of delivery: Automatic welder, transport box, 3 pcs. Allen keys, cleaning brush, Quick guide

Technical data		GEOSTAR G5 / G5 LQS
Voltage	V~	120 / 220 – 240
Frequency	Hz	50 / 60
Power	W	1800 / 2800
Max. heating temperature	°C	460
Welding wedge	mm	90 × 50
Max. overlap	mm	150
Max. welding force	N	1500
Weld width with test channel	mm	2 × 11 / 2 × 15
Drive speed*1	m/min	0.8–12 Level 1: 0.8–6 Level 2: 1.5–12
Dimensions (L × W × H)	mm	482 × 278 × 269
Weight	kg	16.4
Materials		HD-PE 0.8–3.0 mm PP, LD-PE, TPO, FPO, PVC-P*2, CSPE*2, EIA*2 additional materials upon request
Mark of conformity		CE
Protection Class I		⊕

*2: Requires steel wedge

Article No.

- 151.683 GEOSTAR G5, 230V / 2800W, Roller width 50 mm, copper wedge with test channel, with Euro plug
151.618 GEOSTAR G5, 120V / 1800W, Roller width 50 mm, copper wedge with test channel, without plug
156.135 GEOSTAR G5 LQS data recording, 230 V / 2800 W, copper wedge with test channel, with Euro plug

Scope of delivery: Automatic welder, transport box, 3 pcs. Allen keys, cleaning brush, Quick guide

of material, natural flow of material through the machine and innovative handle ergonomics for easy carry and rest positions. The GEOSTAR is available in two performance classes: the standard GEOSTAR G5 and extended-wedge GEOSTAR G7.



The GEOSTAR easily welds 240 m without difficulty in a single pass during a field test (South Africa)..

Accessories

GEOSTAR G7/G7 LQS, G5/G5 LQS

	148.489 Wedge Kit GEOSTAR G7, 130 × 50 mm, 230V/2500W, copper wedge with test channel
	151.684 Wedge Kit GEOSTAR G5, 90 × 50 mm, 230V/2500W, copper wedge with test channel
	153.557 stainless steel wedge with test channel 90 × 50mm, 230V/2500W
	149.174 Wedge-Kit GEOSTAR G5, 90 × 50 mm 120V/1600W, copper wedge with test channel
	153.560 stainless steel wedge with test channel 90 × 50 mm 120V/1600W Other wedges on request
	153.361 Drive roll D50 mm × 50 (75) mm; Traction Step, Steel, pointed knurled, with test channel
	Drive roll D50 mm × 50 mm;
	153.338 Steel, sharp edge knurled, with test channel
	153.359 Steel, blunt edge knurled, with test channel Other rollers on request
	155.568 50mm straight profile Roller w/screw
	154.272 78mm Silicone Rollers w/screw
	154.676 50mm Silicone Rollers w/screw
	146.204 Prefabrication wagon for Geostar
	146.346 Side support for Prefabrication wagon (4 pieces required)
	151.847 Brass brush



For further accessories see www.leister.com/geostar



LQS – Leister Quality System

The Leister Quality System (LQS) allows you to compile full quality documentation for all aspects of your welding work. You can document every welding seam as a table, graphic or even with GPS coordinates. The Leister Quality System provides all the advantages of state of the art technology, helping installers enhance on site QC/QA and installation standards overall.

TWINNY T7 LQS / T5

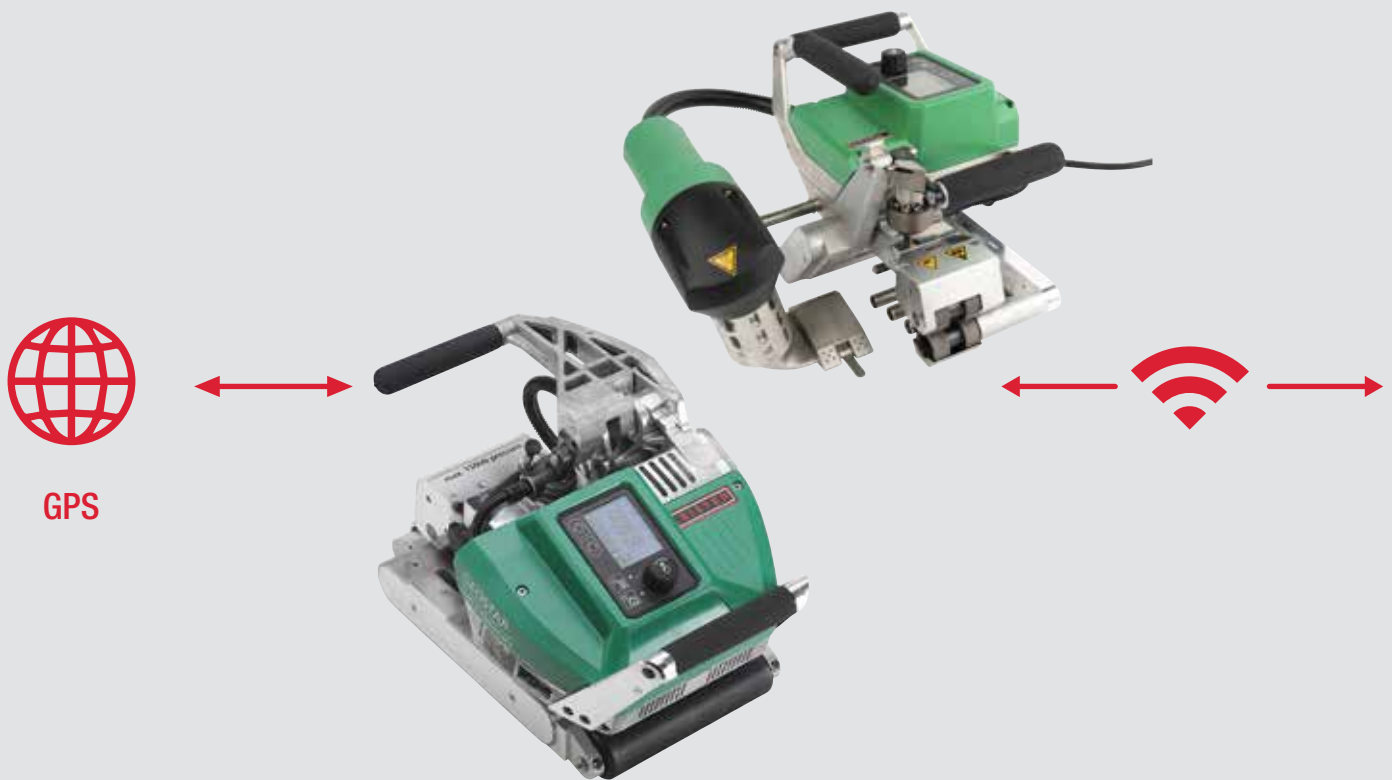

GEOSTAR G7 LQS / G5 LQS



Pinpoint precision

By activating the GPS function, you can assign the welding seams precisely to the relevant location (for GPS and GLONASS format).



LQS

- Activatable data recording
- Welding parameter monitoring via alarm function
- Data storage for 10,000 welds



Wireless data transfer

After the welding process, the data can be transferred conveniently via WiFi. The transfer process only takes a few seconds.





GEOSTAR LQS in field operation.



Civil Engineering /
GEO

Data evaluation on mobile devices
 The data is evaluated digitally via the LQS app. This app can be downloaded free of charge from the Windows or Android Store. The LQS menus are extremely easy to navigate and are adapted to users' needs.

Data cloud
 The data cloud opens up lots of extra possibilities:

- Cloud function can be switched on/off
- External data backup
- Unit management
- User management
- Decentralized access of welding data for remote team members

Welding report
 The LQS app can be used to produce records in all standard forms:

- Welding report
- Tables and graphics
- pdf and csv format

COMET / COMET USB: The highflyers.

This compact, heavy-duty welding machine is in use worldwide. The small powerhouse is specially designed for the demands of landfill sites, mines and tunnels. Documentation made simple: The COMET USB memory system is designed for use on construction sites. Because this compact hot-wedge welding machine records all relevant welding parameters, data transfer is mere child's play.

Wedge welder

COMET



- Lightweight and compact
- Digital display of temperature and velocity
- Closed loop control of temperature and drive
- Easy and user-friendly

Technical Data

Voltage	V~	230
Power	W	1850 / 1500 / 1200
Temperature	°C	80 – 420
Max. overlap	mm	125
Speed	m/min	0.8 – 3.2
Welding pressure	N	100 – 1000
Weld seam width	mm	2 × 15, with test channel
Material thickness	mm	0.5 – 3
Size (L × B × H)	mm	295 × 250 × 245
Weight	kg	7.5
Conformity mark		CE
Protection class I		⊕

Article No.

- 107.547 COMET, with wedge 50 mm for PE, 230 V / 1200 W *
- 107.538 COMET, with wedge 70 mm for PE, 230 V / 1500 W *
- 145.893 COMET, with wedge 95 mm for PE, 230 V / 1850 W *
- 107.558 COMET, with wedge 50 mm for PVC, 230 V / 1200 W *
- 107.553 COMET, with 50mm wedge for PE, 120 V / 1200 W *
- 107.539 COMET, with 70mm wedge for PE, 120 V / 1500 W *

* with test channel, EURO plug

Included with purchase: Welder, quick guide, guide-bar short, storage case

Wedge welder

COMET USB



- Digital display of welding pressure
- Complete recording of all relevant welding parameters
- USB memory system designed for use on construction sites
- Convenient data transfer

Technical Data

Voltage	V~	230
Power	W	1850 / 1500 / 1200
Temperature	°C	80 – 420
Max. overlap	mm	125
Speed	m/min	0.8 – 3.2
Welding pressure	N	100 – 1000
Weld seam width	mm	2 × 15, with test channel
Material thickness	mm	0.5 – 3
Size (L × B × H)	mm	295 × 250 × 245
Weight	kg	7.5
Conformity mark		CE
Protection class I		⊕

Article No.

- 137.626 COMET USB, with wedge 50 mm for PE, 230 V / 1200 W *
- 138.088 COMET USB, with wedge 70 mm for PE, 230 V / 1500 W *
- 146.052 COMET USB, with wedge 95 mm for PE, 230 V / 1850 W *

* with test channel, EURO plug

Included with purchase: Welder, quick guide, guide-bar short, memorystick, storage case





Comet operating in the tunnel ...



... or on a landfill site.

Accessories COMET / COMET USB

	112.974 Extremely light cross handle 145 gram, material: aluminum
	129.224 Guide-bar, complete
	144.416 USB memory stick



Perfectly protected in the storage case.
126.448
 (included with purchase)

	100.327 Driving roller 50 mm, steel, sharp edge knurled, with test channel
	100.328 Driving roller 50 mm, steel, sharp edge knurled, without test channel
	100.329 Driving roller 50 mm, steel, blunt edge knurled, with test channel
	100.330 Driving roller 50 mm, steel, blunt edge knurled, without test channel
	100.331 Driving roller 50 mm, silicon, with test channel
	100.332 Driving roller 50 mm, silicon, without test channel

Roles are compatible with COMET and TWINNY T and S welding machines.

Fields of application COMET / COMET USB

Power	1850 W		1500 W		1200 W	
	Wedge	Material thickness	Wedge	Material thickness	Wedge	Material thickness
PE-HD, PE-C, PP	95 mm copper	1.5 – 3.0 mm	70 mm copper	1.0 – 2.5 mm	50 mm copper	0.5 – 1.5 mm
PE-LD	95 mm copper	1.5 – 3.0 mm	70 mm copper	1.0 – 2.5 mm	50 mm copper	0.5 – 1.5 mm
PVC-P			70 mm steel	2.0 – 3.0 mm	50 mm steel	1.0 – 2.0 mm

Plug and weld – TWINNY T7 und TWINNY T5

If you want to weld thin or thick geomembranes (0.5 to 2.5 mm) 20-100 mills quickly, easily and safely, the TWINNY T7 or TWINNY T5 are your go-to automatic welders. Both tools are well-rounded, thanks to their practical design and intuitive operation. The TWINNY T7 comes equipped with highly-efficient data recording ability thanks to the LQS function, GPS, Wi-Fi and connection to the myLeister app are guaranteed. Plug and weld – TWINNY T7 and T5.

Hot-air welder

TWINNY T7/T5

1		quick drive speed of 0.8 to 8 m/min
2		T7: brushless blower motor significantly greater air volume
3		dry and clean the hot air dries moisture in no time at all, while dust and sand are blown away
4		Optimum handling thanks to clever grip options
5		a. T7: Communication module myLeister with WiFi, GPS, LQS, voltmeter, e-Drive b. T5: Basic functions with digital accuracy
6		Gearbox and motor separated with service-friendly timing belt
7		Reinforced double-row drive chains
8		Field kit for more ground clearance
9		a. T7: digital joining force display b. T5: Force module with overload protection

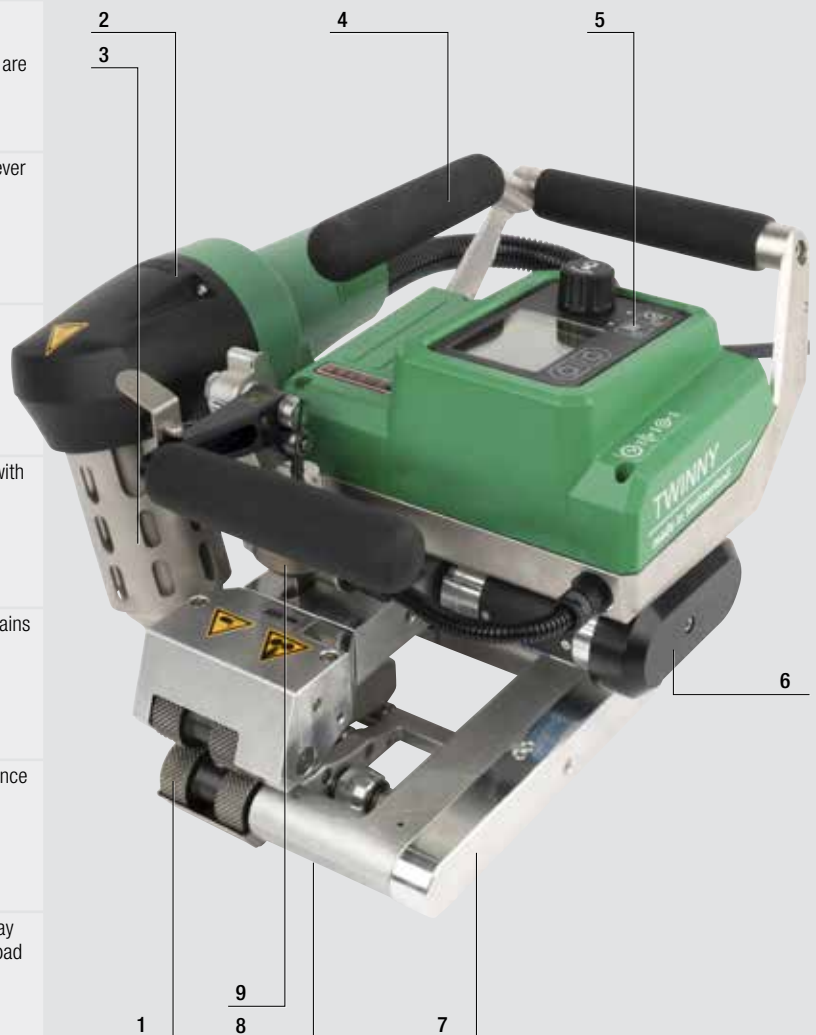



Display TWINNY T7



Display TWINNY T5

Hot-air welder

TWINNY T7/T5



- **powerful:** 3300 watts, enabling more heating power
- **sustainable:** TWINNY T7 and T5 are durable and easy to service

Technical data		TWINNY T7	TWINNY T5
Voltage	V~	230	230 / 120
Frequency	Hz	50 / 60	50 / 60
Power	W	3450	3450 (1800 @ 120V)
Max. Temperature	°C	560	560
Blower Motor	rpm	Maintenance free Brushless Motor max.18'000	Brushed Motor max. 12'000
Air volume	%	45 – 100	
Max. Overlap	mm	125	
Max. Welding pressure	N	1000	
Drive speed	m/min	0.8 – 8	
LQS, WIFI, GPS		Yes	No
Digital Pressure display		Yes	No
Digital Voltage display		Yes	No
Audible / Visual Alarms		Yes	No
Welding pressure overload protection		Visual and acoustical warning	Mechanical
Size (L x W x H)	mm	350 x 360 x 260	
Weight	kg	10.5	9.9
Conformity		CE	
Protection class		⊕	

Accessories TWINNY T7/T5

	155.629	Combi-wedge long, 50 mm, with test channel
	155.630	Combi-wedge long, 50 mm, without test channel
	155.634	Combi-wedge short, 50 mm, with test channel
	155.637	Combi-wedge short, 50 mm, without test channel
	159.135	Long handle complete
	164.025	Indoor roller kit

Article No.:

- CEE blue Euro plug
 164.198 164.197 TWINNY T7 230 V / 3450 W CWL w/TC Ro 50 mm sharp Field kit
 164.215 164.214 TWINNY T7 230 V / 3450 W CWS w/TC Ro 50 mm sharp Field kit
 164.217 164.216 TWINNY T7 230 V / 3450 W CWL wo/TC Ro 50 mm blunt Field kit
 164.219 164.218 TWINNY T7 230 V / 3450 W CWS wo/TC Ro 50 mm blunt Field kit
 164.221 164.220 TWINNY T7 230 V / 3450 W CWS wo/TC Ro 50 mm Silicone Indoor kit
 164.223 164.222 TWINNY T5 230 V / 3450 W CWL w/TC Ro 50 mm sharp Field kit
 164.225 164.224 TWINNY T5 230 V / 3450 W CWS w/TC Ro 50 mm sharp Field kit
 164.227 164.226 TWINNY T5 230 V / 3450 W CWL wo/TC Ro 50 mm blunt Field kit
 164.229 164.228 TWINNY T5 230 V / 3450 W CWS wo/TC Ro 50 mm blunt Field kit
 164.231 164.230 TWINNY T5 230 V / 3450 W CWS wo/TC Ro 50 mm Silicone Indoor kit
 CEE yellow plug
 164.232 TWINNY T5 120 V / 1800 W CWS w/TC Ro 50 mm sharp Field kit
 164.233 TWINNY T5 120 V / 1800 W CWS wo/TC Ro 50 mm blunt Field kit

CWL = Combi wedge long / CWS=Combi wedge short / W/TC = with Test channel / wo/TC = without Test Channel / Ro = Roller width

Scope of delivery: Machine, storage case, cleaning brush, Instruction manual

TWINNY S: Perfect weight.

This lightweight tool is optimized for overhead welding and is ideal for thin materials used in civil engineering and tunnel construction. Leister offers a choice between replaceable combi-wedges with or without test channel.



TWINNY T, with convenient cross-handle, at work overhead welding in a tunnel.

Combi-wedge welder

TWINNY S



- Simple operation
- Lightweight
- High welding speed
- Stepless adjustment of temperature and drive
- Perfect welding result even in harsh environmental conditions thanks to hot-air system.

Technical Data

Voltage	V~	120 / 230
Power	W	2900 / 1900
Temperature	°C	80 – 600
Max. overlap	mm	125
Speed		
drive 256:1	m/min	0.2 – 2.5
drive 144:1		1.4 – 4 (6)
Welding pressure	N	1000 / 500 (256:1 / 144:1)
Size (L x W x H)	mm	350 x 390 x 270
Weight	kg	6.5 – 6.9
Conformity mark		CE
Protection class II		□

Article No.

- 119.031 TWINNY S for tunnel construction, drive 256:1, 230 V / 2900 W, with test channel, combi-wedge long, Euro plug
 119.039 TWINNY S for tunnel construction, drive 256:1, 120 V / 1900 W, with test channel, combi-wedge long, w/o plug

Included with purchase:

Tunneling version: Welder, quick guide, guide-bar short, storage case

Accessories TWINNY S

	112.974 Extremely light cross handle 145 gram, material: aluminum
	Combi-wedge short 100.517 50 mm, with test channel 100.518 50 mm, without test channel
	Combi-wedge long, complete 100.525 50 mm, with test channel 100.526 50 mm, without test channel, slotted, perforated
	126.448 Storage case (included with purchase)
	101.905 230 V / 2750 W heating element, TWINNY S 101.910 230 V / 2100 W heating element, TWINNY S 101.913 120 V / 1800 W heating element, TWINNY S

See COMET for roles.

UNIDRIVE 500: safe and economical – everywhere

Guided by two ergonomic handles, you can achieve the ideal pressure to ensure high-quality welding results. Changing direction – via key combination and dual drive, it couldn't be easier!



The perfect choice for welding joint sealing tape.

Semi-automatic hot-air welder

UNIDRIVE 500



- **Safe:** Constant parameters and reliable quality – even with undervoltage
- **Fast:** Up to three times faster than manual welding
- **Customized:** Reversible drive allows for welding in either direction
- **Practical:** Compact and lightweight semi-automatic hot-air welder: 4.5 kg, 30 cm high
- **Economical:** Maintenance-free, brushless motors

Technical data		UNIDRIVE 500 100 V	UNIDRIVE 500 100-120 V	UNIDRIVE 500 220-240 V
Voltage	V~	100	120	230
Power	W	1500	1800	2200
Temperature	°C	100 – 580		
Air volume	%	45 – 100		
Speed	m/min	0.7 – 4.5		
Emission	L _{pA} (dB)	70 (K = 3 dB)		
Size (L × H × B)	mm	297 × 173 × 275		
Weight	kg	4.5		
Conformity mark		CE		
Protection class I		⊕		

Article No.:

- 163.144 UNIDRIVE 500, 40 mm, 220-240 V / 2200 W, Euro plug, Silicone rollers
 - 163.146 UNIDRIVE 500, 40 mm, 220-240 V / 2200 W, CEE 3 pol. blue, Silicone rollers
 - 163.148 UNIDRIVE 500, 40 mm, 100-120 V / 1800 W, UK plug, Silicone rollers
 - 163.149 UNIDRIVE 500, 40 mm, 100 V / 1500 W, JP plug, Silicone rollers
 - 163.150 UNIDRIVE 500, 30 mm, 220-240 V / 2200 W, EU plug, Silicone rollers
 - 163.151 UNIDRIVE 500, 40 mm, 220-240 V / 2200 W, CEE 3 pol. blue, Steel rollers
 - 163.152 UNIDRIVE 500, 15 mm, 220-240 V / 2200 W, CEE 3 pol. blue, Steel rollers
- Included with purchase: Welding machine, device case, hex key, quick guide

Accessories UNIDRIVE 500

	164.586 15 mm 164.576 30 mm 164.403 40 mm
	163.930 Pressure roller, steel 15 mm
	163.357 Pressure roller steel 40 mm
	162.551 Support wheel, silicone
	161.156 Silicone rubber roller 40 mm
	159.911 Wheel for silicon rubber roller 40 mm
	151.847 Brass brush
	164.605 Storage case UNIDRIVE 500 156.531 Carrying strap for Leister case
	145.582 Heating elements 230 V / 2200 W 165.176 Heating elements 120 V / 2100 W 165.179 Heating elements 100 V / 1600 W

WELDPLAST S6: The workhorse.

WELDPLAST S6 is the world's highest rated handheld extrusion welder. With an output of 6 kg/h, it is surprisingly maneuverable. It features a brushless, preheat motor, multifunction display and comfortable ergo-grip, making the S6 Leister's flagship extrusion welder.



WELDPLAST S6, Gold Mine Mexico.

Digitally regulated extrusion welder

WELDPLAST S6



- 6 kg output per hour
- Highest possible preheating capacity
- Adjustable control wheel
- Maintenance-free hot-air blower
- Multifunctional display

Technical Data

Voltage	V~	230
Power	W	4600
Material		PE /PP
Welding rod	mm	Ø 4 – 5
Output	kg/h	3.9 – 6.0
Size (L x W x H)	mm	821 x 116 x 240
Weight	kg	14
Conformity mark		CE
Protection class I		⊕

Article No.

134.318 Extrusion Welder WELDPLAST S6, 230 V / 4600 W, with CEE 32A plug

Included with purchase: WELDPLAST S6, overlap welding shoe, storage case

Accessories WELDPLAST S6

		146.239 Welding shoe complete
		146.240 54 x 40 x 52 mm blank welding shoe
		146.241 25 mm overlap
		146.706 35 mm overlap
		146.242 35 mm overlap
		145.899 40 mm overlap
		146.245 20 mm V-seam
		146.246 25 mm V-seam
		146.247 30 mm V-seam
		146.232 20 mm fillet weld seam (a = 14 mm*)
		146.233 25 mm fillet weld seam (a = 17.5 mm*)
		146.234 30 mm fillet weld seam (a = 21 mm*)
		146.230 Corner seam Ø 14 mm
		146.218 Corner seam Ø 20 mm
		* a = welding seam thickness
		117.055 35 mm preheat nozzle, large
		136.859 50 mm preheat nozzle, XL large
		117.790 Side hot-air guide (Position 9h/3h)
		116.367 Ultra strong storage case WELDPLAST S6 (included with purchase)
		149.744 Insulation sleeve

General accessories



WELDPLAST S4

The WELDPLAST S4 is the first extrusion welder of its kind with brushless, maintenance-free motor for generating preheated air. Output of up to four kilograms per hour is made possible thanks to the S4's powerful drive system.



The powerful WELDPLAST S4 at work.

Digitally regulated extrusion welder

WELDPLAST S4



- Compact housing design reduces noise and guarantees optimal cooling for the electronics and drive.
- Microprocessor to regulate the welding process and to monitor the tool
- Menu with function programs
- Dual-sided twist-free wire intake
- Maintenance-free blower

Technical Data

Voltage	V~	230
Power	W	3680
Material		PE /PP
Welding rod	mm	Ø 3 – 4 / Ø 4 – 5
Output	kg/h	1.5 – 4.0
Size (L x W x H)	mm	560 x 110 x 300
Weight	kg	8.7
Conformity mark		CE
Protection class I		⊕

Article No.

146.812	WELDPLAST S4, 230 V / 3680 W, 4–5 mm, top hot-air guide, overlap welding shoe 40 mm, preheat nozzle large, with Euro plug, storage case
116.948	WELDPLAST S4, 230 V / 3680 W, 3–4 mm, side hot-air guide, blank welding shoe, preheat nozzle large, medium and small, with Euro plug, storage case

Accessories WELDPLAST S4

	146.239 54 x 40 x 52 mm blank welding shoe
	146.240 74 x 50 x 58 mm blank welding shoe
	146.241 25 mm overlap
	146.706 30 mm overlap
	146.242 35 mm overlap
	145.899 40 mm overlap
	146.243 12 mm V-seam
	146.244 15 mm V-seam
	146.245 20 mm V-seam
	146.246 25 mm V-seam
	146.247 30 mm V-seam
	146.525 12 mm fillet weld seam (a = 8.5 mm*)
	146.231 15 mm fillet weld seam (a = 10 mm*)
	146.232 20 mm fillet weld seam (a = 14 mm*)
	146.233 25 mm fillet weld seam (a = 17.5 mm*)
	146.234 30 mm fillet weld seam (a = 21 mm*)
	146.230 Corner seam Ø 14 mm
	146.218 Corner seam Ø 20 mm
	* a = welding seam thickness
	144.904 45° angled adapter
	145.704 90° angled adapter Caution: You must use welding shoes with an integrated air guide for this
	117.064 Side hot-air guide
	117.065 Top hot-air guide
	117.053 preheat nozzle small, 20 mm
	117.518 medium, 25 mm
	141.177 large, 35 mm
	136.231 Pre-heat reflector
	149.723 Insulation sleeve

WELDPLAST S2: The masterpiece.

The WELDPLAST S2 is a compact, ergonomically designed workhorse. The handy size extruder puts out two kilograms per hour and can even weld TPO materials without difficulty.



The robust WELDPLAST S2 welding a patch in a tunneling application.

Digitally regulated extrusion welder

WELDPLAST S2 / S2 TPO



- Maintenance-free blower
- Perfect weld seam quality
- Multifunctional display
- Ergonomic and handy
- Successfully operated worldwide

Technical Data

Voltage	V~	230
Power	W	3000
Material standard version		PE /PP
Welding rod	mm	∅ 3 – ∅ 4
Output ∅ 3 mm	kg/h	PE: 0.6 – 1.3 PP: 0.5 – 1.2
Output ∅ 4 mm	kg/h	PE: 1.0 – 2.3 PP: 0.9 – 2.0
Size (L × W × H)	mm	450 × 98 × 260
Weight	kg	5.8
Conformity mark		CE
Protection class I		⊕

Article No.

127.215 WELDPLAST S2, 230 V / 3000 W, with Euro plug
 Included with purchase: WELDPLAST S2, blank welding shoe, storage case
 136.602 WELDPLAST S2, 230 V / 3000 W, TPO, with Euro plug
 Included with purchase: WELDPLAST S2, UBL-blank welding shoe, storage case

Accessories WELDPLAST S2 / S2 TPO

	145.945	Welding shoe complete
	145.946	45 × 30 × 54 mm blank welding shoe
	145.896	74 × 50 × 58 mm blank welding shoe
	145.947	25 mm overlap
	145.897	30 mm overlap
	145.915	35 mm overlap
	145.907	8 / 10 mm V-seam
	145.903	12 mm V-seam
	145.909	15 mm V-seam
	145.944	20 mm V-seam
	145.815	8 / 10 mm fillet weld (a = 7 mm*)
	145.812	12 mm fillet weld (a = 8.5*)
	145.940	15 mm fillet weld (a = 10*)
	146.645	20 mm fillet weld (a = 14 mm*)
	146.649	Corner outside seam 10 mm
	146.651	Corner outside seam 12 mm
	145.811	Corner outside seam 15 mm
	145.488	Corner seam ∅ 14 mm
		Corner seam ∅ 20 mm
		* a = welding seam thickness
	139.460	45° angled adapter
	139.461	90° angled adapter
	134.361	Air filter (included with purchase)
	143.776	Textile dust filter (not included with purchase)
	155.829	Air filter
	131.451	Tool rest
	136.231	Preheat reflector
	154.002	Insulation sleeve

General accessories



FUSION 3 / 3C: THE slim twins.

With its long and narrow shape, the FUSION 3 enables comfortable work, even on the ground. The slightly shorter 3C also provides an astounding output volume of up to eight pounds per hour.



Due to its length, the FUSION 3 is especially suited for civil engineering applications.

Air heated extrusion welder

FUSION 3



- High welding performance
- Compact and handy
- Motor start-up protection prevents cold start
- Dual-sided twist-free wire intake
- 360° rotatable welding shoe

Air heated extrusion welder

FUSION 3C



- High welding performance
- Compact and handy
- Motor start-up protection prevents cold start
- Dual-sided twist-free wire intake
- 360° rotatable welding shoe

Technical Data

Welding rod Ø	mm	Version Ø 3 – 4		Version Ø 4 – 5	
		3	4	4	5
Output PE	kg/h	2.0 – 2.5	2.7 – 3.6	2.1 – 2.6	2.7 – 3.6
Output PP	kg/h	1.8 – 2.3	2.5 – 3.4	1.8 – 2.4	2.5 – 3.4
Voltage	V~	230			
Power	W	3500			
Material		PE / PP			
Size (L x W x H)	mm	670 x 90 x 180			
Weight	kg	7.2			
Conformity mark		CE			
Protection class II		□			

Artikel-Nr.

118.300 FUSION 3, 230 V / 3500 W, Welding rod Ø 3 – 4 mm, Euro plug
144.615 FUSION 3, 230 V / 3500 W, Welding rod Ø 4 – 5 mm, Euro plug

Included with purchase: FUSION 3, Welding shoe overlap 30 mm, storage case

Technical Data

Welding rod Ø	mm	Version Ø 3 – 4		Version Ø 4 – 5	
		3	4	4	5
Output PE	kg/h	2.0 – 2.5	2.7 – 3.6	2.1 – 2.6	2.7 – 3.6
Output PP	kg/h	1.8 – 2.3	2.5 – 3.4	1.8 – 2.4	2.5 – 3.4
Voltage	V~	230			
Power	W	3200			
Material		PE / PP			
Size (L x W x H)	mm	588 x 98 x 225			
Weight	kg	6.9			
Conformity mark		CE			
Protection class II		□			

Artikel-Nr.

123.866 FUSION 3C, 230 V / 3200 W, Welding rod Ø 3 – 4 mm, Euro plug
144.826 FUSION 3C, 230 V / 3200 W, Welding rod Ø 4 – 5 mm, Euro plug

Included with purchase: FUSION 3C, blank welding shoe, storage case



The FUSION 3 for comfortable working in upright positions.

Accessories FUSION 3 / FUSION 3C

	145.945	Welding shoe complete
	145.946	45 × 30 × 54 mm blank welding shoe
	145.896	25 mm overlap
	145.947	30 mm overlap
	145.897	35 mm overlap
	145.915	8 / 10 mm V-seam
	145.907	12 mm V-seam
	145.903	15 mm V-seam
	145.909	20 mm V-seam
	145.916	25 mm V-seam
	145.905	30 mm V-seam
	145.944	8 / 10 mm fillet weld (a = 7 mm*)
	145.815	12 mm fillet weld (a = 8.5 mm*)
	145.812	15 mm fillet weld (a = 10 mm*)
	145.940	20 mm fillet weld (a = 14 mm*)
	145.816	25 mm fillet weld (a = 17.5 mm*)
	145.817	30 mm fillet weld (a = 21 mm*)
	146.643	Corner outside seam 8 mm
	146.645	Corner outside seam 10 mm
	146.649	Corner outside seam 12 mm
	146.651	Corner outside seam 15 mm
	145.811	Corner seam Ø 14 mm
	145.488	Corner seam Ø 20 mm
* a = welding seam thickness		
	148.817	45° angled adapter
	148.816	90° angled adapter
	135.082	Air filter in stainless steel FUSION 3C
	131.451	Tool rest WELDPLAST S2 / S2 PVC / FUSION 2 FUSION 3C
	160.454	WELDPLAST S4 / S6 / FUSION 3
	136.231	Preheat reflector
	149.421	Insulation sleeve FUSION 3
	149.420	Insulation sleeve FUSION 3C

General accessories

	144.095	Welding rod de-reeler
	123.173	Storage case WELDPLAST S4 / FUSION 3
	119.540	WELDPLAST S2 / S2 TPO / FUSION 3C (included with purchase)
	134.567	Heating element, 230 V / 2600 W, for WELDPLAST S6
	109.984	230 V / 2200 W, for WELDPLAST S4 / S2
	113.268	230 V / 1100 + 1100 W, for FUSION 3
	123.561	230 V / 1750 W, for FUSION 3C

FUSION 3C with heat blanket.



EXAMO: The inspector.

Is your seam sealed? Can it withstand the specified peel, tensile and shear forces? EXAMO performs tests at the construction site – quick, reliable and uncomplicated.



Blank in uniform size, quickly produced with the COUPON CUTTER 500.

Tensiometer

EXAMO 300F USB, 600F USB



- Construction-site approved
- Handy, robust and reliable
- Testing of elongation, peak force, tear force, test speed and position
- With jaws also suitable for geo textiles (see accessories)
- Electronic recording of the measurement data

Technical Data

Type		300F USB	600F USB
Voltage	V~	230	230
Power	W	200	200
Tensile load	N	4000	4000
Jaw spacing	mm	5 – 300	5 – 600
Range	mm	300	600
Test speed	mm/min	20 – 550	20 – 550
Sample thickness	mm	max. 7	max. 7
Sample width	mm	max. 40 (60 optional)	max. 40 (60 optional)
Size (L x W x H)	mm	750 x 270 x 190 (case)	1050 x 270 x 190 (case)
Weight	kg	14	17.5
Conformity mark		CE	CE
Protection class I		⊕	⊕

Article No.:

- 139.059 EXAMO 300F USB, 230 V / 200 W, incl. USB memory stick, Euro plug
 139.060 EXAMO 600F USB, 230 V / 200 W, incl. USB memory stick, Euro plug

Accessories EXAMO 300F USB, 600F USB

	134.832	Testing and calibration kit to test and calibrate your EXAMO USB
	108.185	Jaw kit 60 mm for geotextiles including two pairs of jaws
	144.416	USB memory-stick
	161.540	COUPON CUTTER 500, for standard-compliant specimens: 15/20/25 x 150 mm
	160.576	Cutting plate
	137.855	Leister cutter with four spare blades
	138.902	Hooked blade for LEISTER-cutter (10 dispenser with 10 pcs=100 pcs)
	138.539	Straight-edge blade for LEISTER-cutter (10 dispenser with 10 pcs = 100 pcs)
	163.140	MEMBRANE PULLER Pull handle for membranes 1.0 – 3.0 mm

VACUUM PUMP / VACUUM BOX: Fast and reliable.

The simple, safe and non-destructive way to test the tightness of overlap weld seams, using the Leister VACUUM BOX/BELL. Soapy water is applied to the welding zone to be checked. After connection to the VACUUM PUMP, a vacuum is generated above the zone with the VACUUM BOX/BELL. Thanks to its generous dimensions, and the practical drain valve, even longer weld seams can be tested quickly and reliably.

Testing instruments

VACUUM BELL



- Simple and precise tightness testing
- Round structural form, ideal for details and uneven surfaces.
- Manometer bar/psi

Testing instruments

VACUUM BOX



- Large testing area
- Simple handling
- Clear arrangement of the fittings
- Manometer bar/psi

Testing instruments

VACUUM PUMP



- Durable VACUUM PUMP
- Perfectly packaged and handy
- Flexible, robust hose

Article No.:

153.026 VACUUM BELL Ø 320 mm

152.981 VACUUM BOX 830 × 320 × 150 mm

153.024 VACUUM PUMP 230V

153.025 VACUUM PUMP 120V

Caution: The complete testing system is made up from a combination of one VACUUM BOX or VACUUM BELL to be operated with one VACUUM PUMP.

Compressed air testing device.

The reliable and handy compressed air testing device from Leister is the perfect solution for testing the tightness of double tap seams with test channels. The revised model now offers even more reliable results – not only during operation but also for the discovery of leaks.



Testing the leak-tightness of lap seams with test channel.

Testing instrument Compressed air testing device with thin testing needle



- Thin, flexible needle
- Simple and precise tightness testing
- High user safety through hand and needle protection
- Manometer with bar and psi scale
- Practical device case



Manometer standard (bar/psi)

Article No.:
142.475 Flexible injection needle with manometer

Accessories



142.569 Flexible spare needle (fits also to 150.720)

Testing instrument Compressed air testing device with thick testing needle



- Very strong, tapered needle
- Simple and precise tightness testing
- High user safety through hand and needle protection
- Manometer with bar and psi scale
- Practical device case



Manometer ASTM (psi/kPa)

Article No.:
150.720 Tapered injection needle with manometer (standard)
158.374 Tapered injection needle with manometer PSI (ASTM)

Accessories



150.142 Tapered Spare needle (fits also to 142.475)





Air purification system, Spain. Material: HD-PE



The Wave House, San Diego. Material: PVC



Electroplating tank, Turkey. Material: PP

Plastic Fabrication

Overview of hand extruders	94
FUSION 1	96 / 97
WELDPLAST S6	98
WELDPLAST S4	99
WELDPLAST S2 / S2 PVC	100 / 101
WELDPLAST 1	102
FUSION 3 / 3C	103 / 104
FUSION 2	105
WELDPLAST 200-i / 600-i	106 / 107
General accessories hand extruders	108
Welding rods	109

Hot-Air Hand Tools

TRIAC ST	12 – 15
TRIAC AT	13 – 15
HOT JET S	18 / 19
AIRSTREAM ST	28 / 29
ROBUST	30
WELDING PEN R / WELDING PEN S	31
DIODE PID / DIODE S	32 / 33
MINOR	33
LABOR S	34
General accessories	36 / 37

Possibilities of welding seams

a = seam size s = material thickness α = milling angle

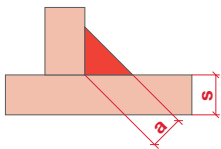

Fillet welding seam

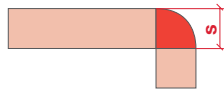

Corner outside seam

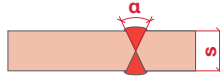

X-seam

s = 10 – 40 mm = α 60°
s = 50 – 60 mm = α 50°

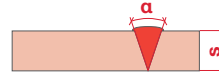





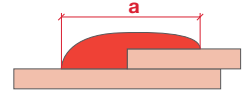



V-seam

s = 5 – 20 mm = α 60°
s = 25 – 30 mm = α 50°



Overlap seam

Product comparison

	Digitally regulated extrusion welders				Air heated extrusion welders			
								
Device type	WELDPLAST S6	WELDPLAST S4	WELDPLAST S2	WELDPLAST S1	FUSION 3	FUSION 3C	FUSION 2	FUSION 1
Output (HDPE) kg/hr	3.9 – 6	1.5 – 4	0.6 – 2.3	0.2 – 0.8	1.8 – 3.6	1.8 – 3.6	1.3 – 1.8	0.2 – 0.8
Material	HD-PE, PP	HD-PE, PP	HD-PE, PP, PVC	PE, PP, PVC, etc.	HD-PE, PP	HD-PE, PP	HD-PE, PP	PE, PP
Wall thickness mm	15 – 40	8 – 35	4 – 20	4 – 10	8 – 25	8 – 25	6 – 15	4 – 10
Welding rod Ø mm	4 – 5	3 – 4 / 4 – 5	3 – 4	3 – 4	3 – 4 / 4 – 5	3 – 4 / 4 – 5	4	3 – 4
Weight kg	14	8.7	5.8	4.7	7.2	6.9	5.9	3.4
Length mm	821	560	450	435	690	588	450	435
Voltage V~	230	230	230	230 / 120	230	230	230	230
Screw extruder	yes	yes	yes	yes	yes	yes	yes	yes
Container construction	✓✓	✓✓	✓✓	✓✓	✓✓	✓✓	✓✓	✓✓
Pipeline construction	✓✓	✓✓	✓✓	✓✓	✓✓	✓✓	✓✓	✓✓
Landfills / civil engineering	✓✓	✓✓	✓	○	✓✓	✓	○	○
Brushless blower	yes	yes	yes	yes	no	no	no	no
Remarks	1	1	1	1	2	2	2	3
Catalog page	 98	99	100 / 101	102	103 / 104	103 / 104	105	96 / 97

✓✓ very suitable ✓ suitable ○ unsuitable

1: Air and Plast temperatures electronically controlled with integrated display.

2: Hot air heated extruder temperature controlled manually.

3: Warm air heated extruder, air temperature electronically controlled with integrated display.

Overview of Extrusion Welders Output (kg/hr)

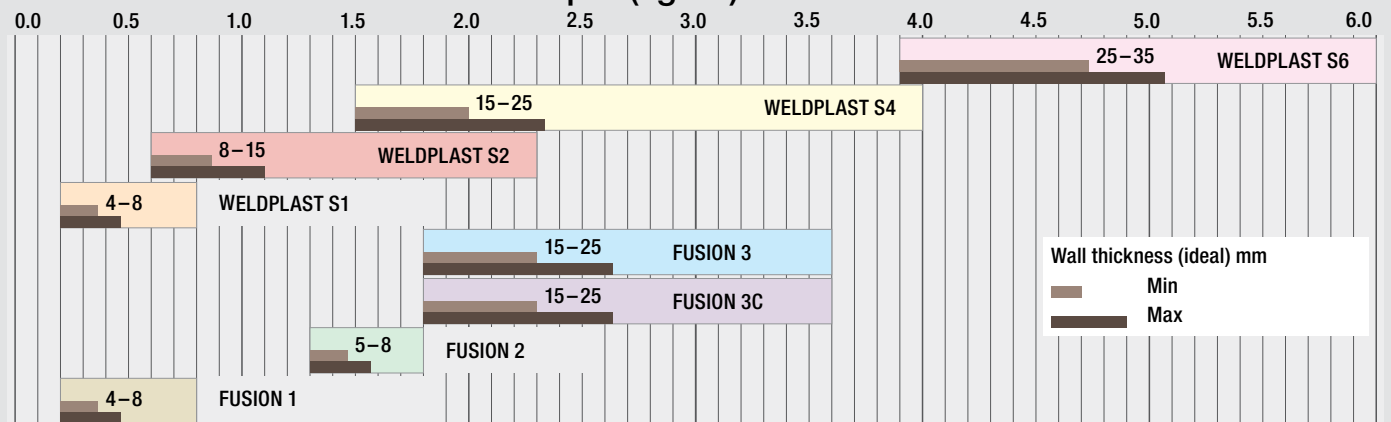



Ingeniously simple – FUSION 1

Your satisfaction is our goal. Which is why we are developing welding devices to meet your requests and requirements. And with the usual LEISTER quality, of course. The reduced design of the FUSION 1 offers increased maneuverability when welding. Flexibility guarantees an optimally mountable handle. Ingeniously simple extrusion welding – FUSION 1.

Digitally regulated extrusion welder

FUSION 1

1		Rod shape: Reduced design for increased maneuverability in small spaces
2		Double-sided wire intake: For more flexibility when welding
3		LED light: To illuminate the welding area
4		Handle: Can be mounted for one-handed welding





FUSION 1 – More flexibility during welding thanks to its slim design.

Digitally regulated extrusion welder

FUSION 1



- **Controlled:** Automatically controlled air temperature
- **Suspension device:** Effortlessly weld longer by hanging up the device
- **Compact and slimline:** Thanks to integrated air guide

Technical data

Voltage	V~	230
Power	W	1200
Materials		PE, PP
Welding rod Ø	mm	3 – 4
Output Ø 3 HD-PE	kg/h	0.2 – 0.5
Output Ø 4 HD-PE	kg/h	0.3 – 0.8
Size (L × B × H)	mm	435 × 92 × 133 (236 with handle)
Weight	kg	3.4
Conformity marking		CE
Protection class II		□

Article No.:

- 162.799 FUSION 1, 120 V / 1450 W, US-plug
- 162.800 FUSION 1, 230 V / 1200 W, Euro-plug
- 163.165 FUSION 1, 230 V / 1200 W, Industrial CEE-plug

Included with purchase: FUSION 1, case, welding shoe, Allen key, quick guide, handle

Accessories FUSION 1

	163.793 Welding shoe CL14 IA
	163.778 Welding shoe K5/6 IA
	163.780 Welding shoe K8/10 IA
	163.779 Welding shoe K12 IA
	163.782 Angled welding shoe AK-10 70°
	163.784 Angled welding shoe AK-10 30°
	163.785 Angled welding shoe AV-10 30°
	163.786 Welding shoe Rohling IA
	162.665 Insulation sleeve

WELDPLAST S6: The workhorse.

WELDPLAST S6 is the world's highest rated handheld extrusion welder. With an output of 6 kg/hr, it is surprisingly maneuverable. It features a brushless, preheat motor, multifunction display and comfortable ergo-grip – making the S6 Leister's flagship extrusion welder.



The WELDPLAST S6 is guided easily with the practical control wheel grip.

Digitally regulated extrusion welder

WELDPLAST S6



- 6 kg output per hour
- Highest possible preheating capacity
- Adjustable control wheel
- Maintenance-free hot-air blower
- Multifunctional display

Technical Data

Voltage	V~	230
Power	W	4600
Material		PE / PP
Welding rod	mm	Ø 4 or Ø 5
Output	kg/h	3.9 – 6.0
Size (L x W x H)	mm	821 x 116 x 240
Weight	kg	14
Conformity mark		CE
Protection class I		⊕

Article No.:

134.318 WELDPLAST S6, 230 V / 4600 W, Industrial CEE-plug 32A

Included with purchase: WELDPLAST S6, overlap welding shoe, storage case

Accessories WELDPLAST S6

		146.239	Welding shoe complete
		146.240	54 x 40 x 52 mm blank welding shoe
		146.241	25 mm overlap
		146.706	30 mm overlap
		146.242	35 mm overlap
		145.899	40 mm overlap
		146.245	20 mm V-seam
		146.246	25 mm V-seam
		146.247	30 mm V-seam
		146.232	20 mm fillet weld seam (a = 14 mm*)
		146.233	25 mm fillet weld seam (a = 17.5 mm*)
		146.234	30 mm fillet weld seam (a = 21 mm*)
		146.644	Corner outside seam 10 mm
		146.646	Corner outside seam 12 mm
		146.652	Corner outside seam 15 mm
		146.230	Corner seam Ø 14 mm
		146.218	Corner seam Ø 20 mm
		*a = Welding seam thickness	
		117.055	35 mm preheating nozzle, large
		136.859	50 mm preheat nozzle, XL Large
		117.790	Side hot-air guide
		149.744	Insulation sleeve WELDPLAST S6

WELDPLAST S4: The workmate.

The WELDPLAST S4 is the first extruder of its kind with a brushless, maintenance-free motor for generating pre-heated air. Output of up to four kilograms per hour is made possible thanks to the S4's powerful drive system.



The powerful WELDPLAST S4 in use.

Digitally regulated extrusion welder

WELDPLAST S4



- Compact housing design reduces noise and guarantees optimal cooling for the electronics and drive.
- Microprocessor regulates the welding process and monitors the tool
- Menu with function programs
- Dual-sided, twist-free wire intake
- Maintenance-free blower

Technical Data

Voltage	V~	230
Power	W	3680
Material		PE / PP
Welding rod	mm	Ø 3 – 4 / Ø 4 – 5 mm
Output	kg/h	1.5 – 4.0
Size (L x W x H)	mm	560 x 110 x 300
Weight	kg	8.7
Conformity mark		CE
Protection class I		⊕

Article No.:

- 116.948 WELDPLAST S4, 230 V / 3680 W, 3 – 4 mm, Euro plug, blank welding shoe
- 146.813 WELDPLAST S4, 230 V / 3680 W, 4 – 5 mm, Euro plug, welding shoe K 15
- Included with purchase: WELDPLAST S4, preheat nozzle large, medium and small, storage case

Accessories WELDPLAST S4

	146.239	54 x 40 x 52 mm blank welding shoe
	146.240	74 x 50 x 58 mm blank welding shoe
	146.241	25 mm overlap
	146.706	35 mm overlap
	146.242	35 mm overlap
	145.899	40 mm overlap
	146.243	12 mm V-seam
	146.244	15 mm V-seam
	146.245	20 mm V-seam
	146.246	25 mm V-seam
	146.247	30 mm V-seam
	146.525	12 mm fillet weld seam (a = 8.5 mm*)
	146.231	15 mm fillet weld seam (a = 10 mm*)
	146.232	20 mm fillet weld seam (a = 14 mm*)
	146.233	25 mm fillet weld seam (a = 17.5 mm*)
	146.234	30 mm fillet weld seam (a = 21 mm*)
	146.642	Corner outside seam 8 mm
	146.644	Corner outside seam 10 mm
	146.646	Corner outside seam 12 mm
	146.652	Corner outside seam 15 mm
	146.230	Corner seam Ø 14 mm
	146.218	Corner seam Ø 20 mm
		* a = Welding seam thickness
	144.904	Angled adapter 45°
	145.704	Angled adapter 90°
		Caution: You must use welding shoes with an integrated air guide for this.
	117.064	Side hot-air guide
	117.065	Top hot-air guide
	117.053	Preheat nozzle
	117.518	20 mm, small
	141.177	25 mm, medium
	149.723	35 mm, large
	149.723	Insulation sleeve WELDPLAST S4

Plastic Fabrication

General accessories



WELDPLAST S2 / S2 PVC: The masterpieces.

WELDPLAST S2 and S2 PVC are masterpieces of modern technology. While externally they fulfill the highest requirements of functionality and design, their interior satisfies the highest expectations concerning the material to be processed. The WELSDPLAST S2 PVC has integrated corrosion protection and has been especially designed to satisfy the high requirements of PVC extrusion welding. Their perfect seam quality makes both – WELDPLAST S2 and S2 PVC – reliable partners for today and tomorrow.

Digitally regulated extrusion welder

WELDPLAST S2



- Maintenance-free blower
- Perfect weld seam quality
- Multifunctional display
- Ergonomic and handy
- Successfully operated worldwide

Technical Data

Voltage	V~	230
Power	W	3000
Material		PE / PP Other materials on request
Welding rod	mm	Ø 3 oder Ø 4
Output Ø 3 mm	kg/h	PE: 0.6 – 1.3 PP: 0.5 – 1.2
Output Ø 4 mm	kg/h	PE: 1.0 – 2.0 PP: 0.9 – 2.0
Size (L x W x H)	mm	450 x 98 x 260
Weight	kg	5.8
Conformity mark		CE
Protection class I		⊕

Article No.:

127.215 WELDPLAST S2, 230 V / 3000 W, Euro plug
 156.131 WELDPLAST S2, 230 V / 3000 W, Industrial CEE-plug
 Included with purchase: WELDPLAST S2, welding shoe raw part, storage case

Digitally regulated extrusion welder

WELDPLAST S2 PVC



- Optimized for PVC-U
- Perfect weld seam quality
- PVC specific extrusion menu
- Corrosion protection
- Standby mode

Technical Data

Voltage	V~	230
Power	W	3000
Material		PVC-U, PE, PP Other materials on request
Welding rod	mm	Ø 3 oder Ø 4
Output Ø 3 mm	kg/h	PVC-U: 0.9 – 1.7 PE: 0.6 – 1.3
Output Ø 4 mm	kg/h	PVC-U: 1.5 – 2.7 PE: 1.0 – 2.3
Size (L x W x H)	mm	450 x 98 x 260
Weight	kg	5.8
Conformity mark		CE
Protection class I		⊕

Article No.:

135.724 WELDPLAST S2 PVC, 230 V / 3000 W, Euro plug
 156.804 WELDPLAST S2 PVC, 230 V / 3000 W, Industrial CEE-plug

Included with purchase: WELDPLAST S2 PVC, 3 preheating nozzles,
 welding shoe K 8 / 10 mm (Art. no. 146.236), storage case



The handy WELDPLAST S2 in action.



Easy welding of contours.

Accessories WELDPLAST S2

		Welding shoe complete
		145.945 45 × 30 × 54 mm blank welding shoe
		145.946 74 × 50 × 58 mm blank welding shoe
		145.896 25 mm overlap
		145.947 30 mm overlap
		145.897 35 mm overlap
		145.912 5 / 6 mm V-seam
		145.915 8 / 10 mm V-seam
		145.907 12 mm V-seam
		145.903 15 mm V-seam
		145.909 20 mm V-seam
		145.916 25 mm V-seam
		145.943 5 / 6 mm fillet weld (a = 4.2 mm*)
		145.944 8 / 10 mm fillet weld (a = 7 mm*)
		145.815 12 mm fillet weld (a = 8.5 mm*)
		145.812 15 mm fillet weld (a = 10 mm*)
		145.940 20 mm fillet weld (a = 14 mm*)
		145.816 25 mm fillet weld (a = 17.5 mm*)
		146.643 Corner outside seam 8 mm
		146.645 Corner outside seam 10 mm
		146.649 Corner outside seam 12 mm
		146.651 Corner outside seam 15 mm
		145.811 Corner seam Ø 14 mm
		145.488 Corner seam Ø 20 mm
		* a = Welding seam thickness
		139.460 45° angled adapter
		139.461 90° angled adapter
		154.002 Insulation sleeve WELDPLAST S2
		161.119 Support clamp WELDPLAST S2



With the WELDPLAST S2 perfect welds are possible

Accessories WELDPLAST S2 PVC

		Welding shoe complete
		146.239 54 × 40 × 52 mm blank welding shoe
		146.240 74 × 50 × 58 mm blank welding shoe
		146.241 25 mm overlap
		146.706 30mm overlap
		146.242 35 mm overlap
		146.248 5 / 6 mm V-seam
		146.249 8 / 10 mm V-seam
		146.243 12 mm V-seam
		146.244 15 mm V-seam
		146.235 5/6 mm fillet weld seam (a = 4.2 mm*)
		146.236 8/10 mm fillet weld seam (a = 7 mm*)
		146.525 12 mm fillet weld seam (a = 8.5 mm*)
		146.231 15 mm fillet weld seam (a = 10 mm*)
		146.642 Corner outside seam 8 mm
		146.644 Corner outside seam 10 mm
		146.646 Corner outside seam 12 mm
		146.652 Corner outside seam 15 mm
		146.230 Corner seam Ø 14 mm
		146.218 Corner seam Ø 20 mm
		* a = Welding seam thickness
		133.850 Top hot-air guide



The 45° angled adapter for the WELDPLAST S2 facilitates welding in difficult positions. (accessory)

General accessories 108

WELDPLAST S1: Outstandingly compact.

With the new WELDPLAST S1 compact extruder, you can achieve perfect seam quality



Unattainable is weldable with the new 45° and 90°angled adapters.

Digitally regulated extrusion welder

WELDPLAST S1



- Functional, ergonomic design with comfort grip areas
- Extremely high output power of 0.8 kg/h (HD-PE)
- Integrated LED lighting and hanging point
- Can work with all typical kinds of plastic
- Multifunction panel with predefined welding parameters
- BL blower, adjustable air volume

Technical Data

Voltage	V~	230 / 120 / 100
Power	W	1600 / 1800 / 1500
Material		HD-PE, LD-PE, PP, PVC-U PVC-C, PVDF, ECTFE, PA
Welding rod	mm	Ø 3 – 4
Output	kg/h	0.2 – 0.8 (PVC up to 1.15 kg/h)
Size (L × W × H)	mm	435 × 91 × 264
Integrated welding profiles		HD-PE, PP, PVC-U, PVC-C, PVDF 10 free profile storage spaces
Weight	kg	4.7
Conformity mark		CE
Protection class I		⊕

Article No.:

- 148.396 WELDPLAST S1, 230 V / 1600 W, Ø 3 – 4 mm, Euro plug
- 148.395 WELDPLAST S1, 120 V / 1800 W, Ø 3 – 4 mm, without plug
- 148.394 WELDPLAST S1, 100 V / 1500 W, Ø 3 – 4 mm, Euro plug

Included with purchase: WELDPLAST S1, quick guide, 4 pre-heating nozzles Ø 14 mm, welding shoe K10, storage case

Accessories WELDPLAST S1

	149.430	Welding shoe complete Blank
	149.402	Fillet weld 5/6
	148.627	Fillet weld 8/10
	149.401	Fillet weld 12
	149.388	V-seam 3 / 4
	149.383	V-seam 5 / 6
	149.385	V-seam 8 / 10
	149.364	Corner For additional welding shoes, see Weldplast S2 PVC
	152.720	Nozzle extension
	153.143	Angled adapter 45°
	153.236	Angled adapter 90°
	149.600	Top hot-air guide
	149.456	Hot-air tube, position 6h Ø 14 mm
	149.461	Hot-air tube, position 6h Ø 16 mm
	149.467	Hot-air tube, position 9h/3h Ø 14 mm (standard)
	149.469	Hot-air tube, position 9h/3h Ø 16 mm
	154.107	Air nozzle set Ø 14 mm (standard)
	154.106	Air nozzle set Ø 16 mm
	154.002	Insulation sleeve WELDPLAST S1/S2

FUSION 3: Long and slim.

With its long and narrow shape, the FUSION 3 enables comfortable work, even on the floor.

Air heated extrusion welder

FUSION 3



- High-quality welding performance
- Compact and handy
- Motor start-up protection prevents cold start
- Simple operation
- Dual-sided twist-free wire intake
- 360° rotating welding shoe

Technical Data

		Version Ø 3 – 4		Version Ø 4 – 5	
Welding rod Ø	mm	3	4	4	5
Output PE	kg/h	2.0 – 2.5	2.7 – 3.6	2.1 – 2.6	2.7 – 3.6
Output PP	kg/h	1.8 – 2.3	2.5 – 3.4	1.8 – 2.4	2.5 – 3.4
Voltage	V~	230			
Power	W	3500			
Material		PE / PP			
Size (L × W × H)	mm	670 × 90 × 180			
Weight	kg	7.2			
Conformity mark		CE			
Protection class II		□			

Article No.:

118.300 FUSION 3, 230 V / 3500 W, welding rod Ø 3 – 4 mm, Euro plug
 144.615 FUSION 3, 230 V / 3500 W, welding rod Ø 4 – 5 mm, Euro plug

Included with purchase: FUSION 3, welding shoe overlap 30 mm, storage case

FUSION 3C: Short and handy.

The somewhat shorter FUSION 3C provides an astounding output volume of up to 3.6 kilograms per hour.

Air heated extrusion welder

FUSION 3C



- High-quality welding performance
- Compact and handy
- Motor start-up protection prevents cold start
- Simple operation
- Dual-sided, twist-free wire intake
- 360° rotating welding shoe

Technical Data

		Version Ø 3 – 4		Version Ø 4 – 5	
Welding rod Ø	mm	3	4	4	5
Output PE	kg/h	2.0 – 2.5	2.7 – 3.6	2.1 – 2.6	2.7 – 3.6
Output PP	kg/h	1.8 – 2.3	2.5 – 3.4	1.8 – 2.4	2.5 – 3.4
Voltage	V~	230			
Power	W	3200			
Material		PE / PP			
Size (L × W × H)	mm	588 × 98 × 225			
Weight	kg	6.9			
Conformity mark		CE			
Protection class II		□			

Article No.:

123.866 FUSION 3C, 230 V / 3200 W, welding rod Ø 3 – 4 mm, Euro plug
 144.826 FUSION 3C, 230 V / 3200 W, welding rod Ø 4 – 5 mm, Euro plug

Included with purchase: FUSION 3C, blank welding shoe, storage case







































Perfectly stored in the case.



FUSION 3C during the welding of a V-seam.

Accessories FUSION 3 / 3C

		Welding shoe complete
		145.945 45 × 30 × 54 mm blank welding shoe
		145.946 74 × 50 × 58 mm blank welding shoe
		145.896 25 mm overlap
		145.947 30 mm overlap
		145.897 35 mm overlap
		145.912 5 / 6 V-seam
		145.915 8 / 10 mm V-seam
		145.907 12 mm V-seam
		145.903 15 mm V-seam
		145.909 20 mm V-seam
		145.916 25 mm V-seam
		145.943 5 / 6 mm fillet weld (a = 4.2 mm*)
		145.944 8 / 10 mm fillet weld (a = 7 mm*)
		145.815 12 mm fillet weld (a = 8.5 mm*)
		145.812 15 mm fillet weld (a = 10 mm*)
		145.940 20 mm fillet weld (a = 14 mm*)
		145.816 25 mm fillet weld (a = 17.5 mm*)
		146.643 Corner outside seam 8 mm
		146.645 Corner outside seam 10 mm
		146.649 Corner outside seam 12 mm
		146.651 Corner outside seam 15 mm
		145.811 Corner seam Ø 14 mm
		145.488 Corner seam Ø 20 mm
		* a = Welding seam thickness
		148.817 45° angled adapter
		148.816 90° angled adapter
		149.421 Insulation sleeve FUSION 3
		149.420 Insulation sleeve FUSION 3C

The insulation sleeve protects the machine from heat loss, as well as protects the operator from direct contact with the extruder.



FUSION 2: The small powerhouse.

The FUSION 2 convinces with its ergonomic design. The simple operation and first-class welding quality have helped it to become the breakthrough product.



In operation during container construction in China.

Air heated extrusion welder

FUSION 2



- At 450 mm, it is the shortest in its performance class!
- Motor start-up protection prevents cold start
- Simple operation
- Dual-sided, twist-free wire intake
- 360° rotating welding shoe
- Integrated electronics for stepless adjustment of the preheating temperature and output quantity

Technical Data

Voltage	V~	230 / 120
Power	W	2800
Material		PE / PP
Air temperature	°C	up to 340
Plastification temperature	°C	up to 300
Welding rod	mm	∅ 4
Output PE	kg/h	1.3 – 1.8
Size (L × W × H)	mm	450 × 98 × 225
Weight	kg	5.9
Conformity mark		CE
Protection class II		□

Artikel-Nr.

- 119.200 FUSION 2, 230 V / 2800 W, Euro plug
150.102 FUSION 2, 120 V / 2800 W, CEE plug

Included with purchase: FUSION 2, blank welding shoe, storage case

Accessories FUSION 2

	Welding shoe complete	
	145.945	45 × 30 × 54 mm blank welding shoe
	145.946	74 × 50 × 58 mm blank welding shoe
	145.896	25 mm overlap
	145.947	30 mm overlap
	145.897	35 mm overlap
	145.912	5 / 6 V-seam
	145.915	8 / 10 mm V-seam
	145.907	12 mm V-seam
	145.903	15 mm V-seam
	145.943	5 / 6 mm fillet weld (a = 4.2 mm*)
	145.944	8 / 10 mm fillet weld (a = 7 mm*)
	145.815	12 mm fillet weld (a = 8.5 mm*)
	145.812	15 mm fillet weld (a = 10 mm*)
146.643	Corner outside seam 8 mm	
146.645	Corner outside seam 10 mm	
146.649	Corner outside seam 12 mm	
146.651	Corner outside seam 15 mm	
145.811	Corner seam ∅ 14 mm	
145.488	Corner seam ∅ 20 mm	
		* a = Welding seam thickness
	147.602	45° angled adapter
	147.601	90° angled adapter
	166.524	Insulation sleeve FUSION 2

Automated, modular, customized – WELDPLAST 200-i / 600-i

LEISTER offers you two modules for automated extrusion welding and 3D printing. WELDPLAST 200-i and 600-i are set up to allow both simple and fully automated expansion and can be mounted on robots or integrated into machines. This modular design allows you to bring your projects to fruition without making any compromises.

Built-in extruder module

WELDPLAST 200-i / 600-i



Customized
Depending on requirements – choose between extruder modules which can be extended to meet specific needs



Modular
Select an extruder module and simply add the relevant hot air and communication components



Controlled
Monitor and control all parameters such as temperatures and emissions

The drive and communication components of both extruder modules, which can be freely chosen by the user, can be tailored fully to meet individual needs. By incorporating additional sensors, the process can be controlled and monitored as required.

Electrical and mechanical adaptation points are already set up so that the modules for various processes such as those requiring preheated air can be integrated.

State-of-the-art industrial interfaces or similar interfaces can be installed to aid communication.

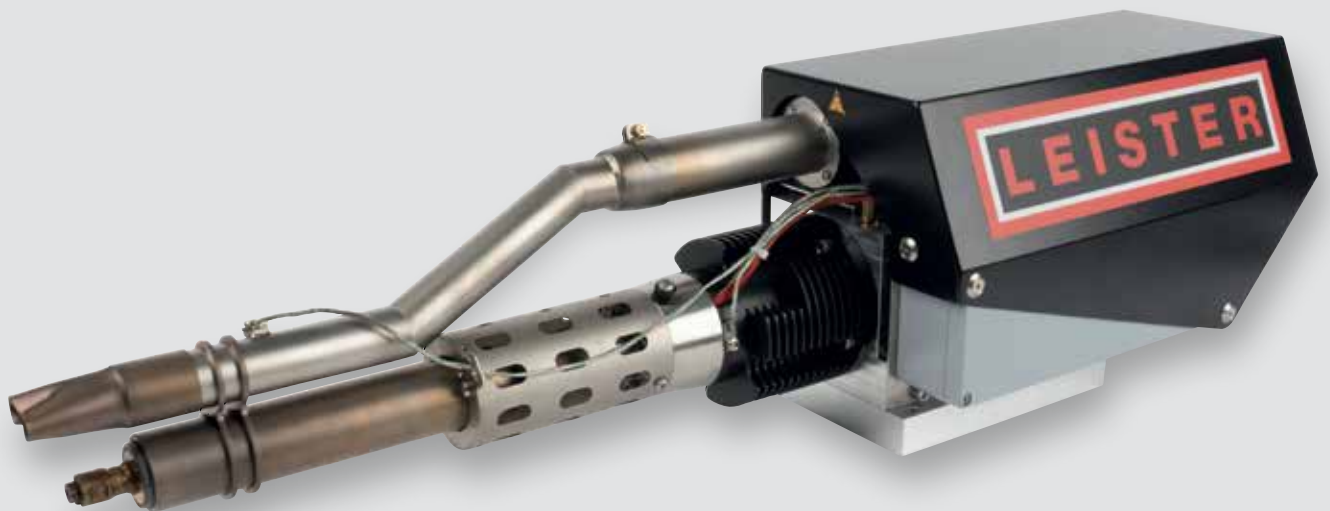



WELDPLAST 200-i / 600-i – robotic extrusion welding and 3D printing designed for automated continuous operation

Built-in extruder module

WELDPLAST 200-i / 600-i



- **Automated:** Designed for automated continuous operation
- **Up to date:** All components are compliant with current industry standards



Technical data		WELDPLAST 200-i	WELDPLAST 600-i
Heating voltage	V~	230	230
Heating power	W	600	800
Welding rods / filament Ø	mm	3 – 4	4 – 5
Output Ø 4 HD-PE	kg/h	2	6
Plastic		HD-PE, LD-PE, PP, PVC-U, PVC-C, PVDF, ECTFE, ABS, PC, PA, PS, PUR	HD-PE, LD-PE, PP
Weight full disassembly	kg	15	22
Dimensions full disassembly (L x W x H)	mm	660 x 191 x 220	876 x 191 x 210
Protection class I		⊕	⊕

Included with purchase: Extrusion module, CAD data, parts list, operating manual, suggested electrical diagram

WELDPLAST 200-i

	163.322 Extruder module 200-i
	163.575 Connection kit 200-i / 600-i
	164.414 Preheated air kit 200-i
	139.869 LHS 21S Classic 140.455 LHS 21S Premium 140.459 LHS 21S System

WELDPLAST 600-i

	163.326 Extruder module 600-i
	163.575 Connection kit 200-i / 600-i
	164.415 Preheated air kit 600-i
	139.872 LHS 21L Classic 140.457 LHS 21L Premium 140.461 LHS 21L System

Plastic Fabrication



Draw welding on a PE-container with the DIODE PID.



The WELDPLAST S4 during outdoor use in Spain.

General accessories hand extruder

	<p>Tool rest 131.451 WELDPLAST S2 / S2 PVC / FUSION 2 / FUSION 3C 148.923 WELDPLAST S1 160.454 WELDPLAST S4 / WELDPLAST S6 / FUSION 3</p>		<p>154.259 Scraper blade</p>
	<p>Pre-heat reflector 136.231 WELDPLAST S1/S2 / S2 PVC / S4 / S6 / FUSION 2 / 3 / 3C</p>		<p>154.026 Contour scraper 165.734 Spare blade set of 3 pcs</p>
	<p>134.361 Air filter WELDPLAST S1 / S2 / S2 PVC (included with purchase) 143.776 Textile dust filter WELDPLAST S1 / S2 PVC (in combination with Air filter) (not included with purchase) 135.082 Air filter FUSION 2 / 3C 155.829 Air filter WELDPLAST S2</p>		<p>Heating element 134.567 230 V / 2600 W, WELDPLAST S6 109.984 230 V / 2200 W, WELDPLAST S4 / S2 / S2 PVC 113.268 230 V / 1100 + 1100 W, FUSION 3 123.561 230 V / 1750 W, FUSION 2 / 3C 149.265 230 V / 1000 W, WELDPLAST S1 149.529 120 V / 1100 W, WELDPLAST S1 149.530 100 V / 1050 W, WELDPLAST S1 151.026 120 V / 1750 W, FUSION 2 161.941 230 V / 900 W, FUSION 1 112.963 120 V / 1150 W, FUSION 1</p>
	<p>153.009 Corner Press Tool</p>		
	<p>152.676 Welding Gauge</p>		
	<p>144.095 Welding rod de-reeler</p>		
	<p>Storage case (included with purchase) 116.367 WELDPLAST S6 123.173 WELDPLAST S4 / FUSION 3 119.540 WELDPLAST S2 / S2 PVC / S1 / FUSION 2/ 3C 162.060 FUSION 1</p>		

PLASTFIX lends the weld seam the necessary holding pressure.





Welding rods

Article		Profile	Colour	kg
Welding accessories PE				
104.283	HDPE welding rod	A	■	3
104.294	HDPE welding rod	A	□	3
104.284	HDPE welding rod	B	■	5
104.299	HDPE welding rod	B	□	5
106.650	HDPE welding band	C	□	1
104.300	LDPE welding rod	A	■	3
161.612	HDPE welding rod	D	■	2
116.918	HDPE welding rod	D	□	2
Welding accessories PP				
104.287	PP welding rod	A	■	3
104.301	PP welding rod	A	■	3
106.642	PPs welding rod, flame resistant	A	■	3
104.288	PP welding rod	B	■	5
126.356	PP welding band	C	□	2
161.611	PP welding rod	D	■	2
Welding accessories PVC				
104.296	PVC-U welding rod	A	□	3
104.278	PVC-U welding rod	A	■	3
106.641	PVC-U welding rod	A	■	3
104.280	PVC-U welding rod	B	■	5
104.279	PVC-U welding rod	B	■	5
109.925	PVC-U welding rod	D	■	4
104.302	PVC-P welding rod (soft)	A	□	3
Welding accessories ABS				
104.295	ABS welding rod	A	□	3
113.587	ABS welding rod	A	■	3
107.027	ABS welding band	C	□	1

Article		Profile	Colour	kg
Welding accessories div.				
104.297	PA welding rod	A	■	3
104.298	PC welding rod	A	□	3
104.313	PC welding rod / ABS / ALPHA (Honda)	A	■	3
104.308	PUR welding rod	A	■	3
106.654	Xenoy welding band	C	■	2
104.304	PVDF welding rod	A	□	3
104.303	POM welding rod	A	□	3
112.185	PC/PBTP Xenoy welding rod	A	□	3
Test bundles				
107.036	Test bundle bodywork welding rods, each consisting of profile A pieces of 37 cm single marked 6× HDPE, 6× PP, 6× PA, 6× PC, 6× ABS, 6× PCABS / ALPHA Honda, 6× PC / PBTP / Xenoy			
107.037	Test bundles standard each consisting of profile A pieces of 37 cm single marked 5× PVC-U, 5× PVC-P, 5× PP, 5× ABS, 5× HDPE, 3× PC, 3× PA, 3× POM, 3× LDPE, 3× PC / ABS / ALPHA Honda, 3× PC / PBTP / Xenoy			
107.040	Test bundle welding band each consisting of profile A pieces of 37 cm single marked 9× HDPE, 8× 2 mm white, 9× PP, 8× 2 mm natural, 9× ABS, 8× 2 mm white, 9× PC / PBTP / Xenoy grey			

Profile sizes

Profile A	Profile B	Profile C	Profile D

Dimensions in mm





Promotes the life of the floor.



For aseptic applications.



Suitable for frequent cleaning.

Flooring / Interior Decoration

Product overview	112
Flooring welding procedures	113
UNIFLOOR 500	114 / 115
MINIFLOOR / MINIFLOOR Drive Unit	116 / 117
GROOVER 500-LP	118 / 119
GROOVER	120
GROOVY	121
General accessories	122

Hot-Air Hand Tools

TRIAC ST	12 / 15
TRIAC AT	13 / 15
ELECTRON ST	16 / 17
HOT JET S	18 / 19
GHIBLI AW	22 / 23
General accessories	36 / 37

Overview Flooring



Typ		GROOVER 500-LP	GROOVER	MINIFLOOR	UNIFLOOR 500
Area of application		Cordless Grooving machine for elastic floor coverings	Grooving machine for elastic floor coverings	Drive unit for welding elastic floor coverings	Welder for welding elastic floor coverings
Groove wide	mm	2.8 / 3.5	2.5 / 2.8 / 3.5 / 4.0	2.5 – 4.0	2.5 – 5.0
Groove depth	mm	0.0 - 6.0	0.0 – 4.0	2.5 – 4.0	2.5 – 4.0
Speed	m/min		Phase 1 (Linoleum) 4 – 6 Phase 2 (PVC, TPU, PU) 8 – 12	0.5 – 4.5	0.7 – 7.5
Temperature	°C	-	-	40 – 620 (with TRIAC AT)	100 – 560
Air flow range	%	-	-	20 – 100 (with TRIAC AT)	45 – 100
Voltage	V	120 / 230	120 / 230	100 – 230	230 / 120 / 100
Frequenz	Hz	-	50 / 60	50 / 60	50 / 60
Power	W	90	Phase 1 (Linoleum) 350 Phase 2 (PVC, TPU, PU) 700	drive unit 5 with TRIAC AT 1605	2300 / 1800 / 1500
Weight	kg	5.5	6.7	5.3 6.6	15.5
Size	mm	445 x 212 x 336	240 x 205 x 255	310 x 225 x 245 495 x 225 x 295	562 x 289 x 440
Cable length	m	-	3	3	3

Startup parameters*

Materials	Linoleum, PVC, TPU, PU	Linoleum (Phase 1)	PVC, TPU, PU (Phase 2)	Linoleum	PVC, TPU, PU	Linoleum	PVC, TPU, PU	
Speed	m/min	-	5	10	1.5	1.5	2.2	2.5
Temperature	°C	-	-	-	400 – 450	500 – 550	400 – 450	450 – 550
Air flow range	%	-	-	-	100%	100%	100%	100%
Catalog page	 118 / 119	120		116		114 / 115		

*The parameters listed are purely reference values (room temperature 20°C). A test weld which takes into account the information provided by the material manufacturer is absolutely essential.

Closed-loop system

The closed-loop technology means that the parameters are kept constant at all times, even in the event of voltage fluctuations, enabling reliable welding in the building site environment.

Closed loop System

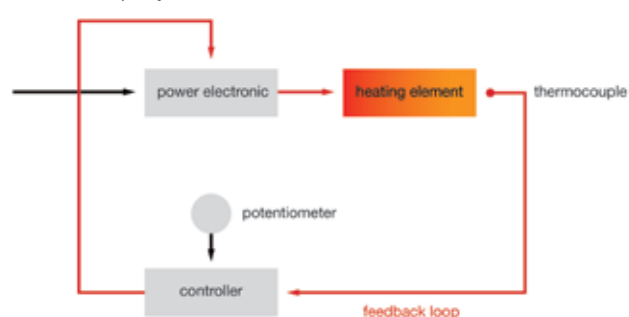

Open loop System

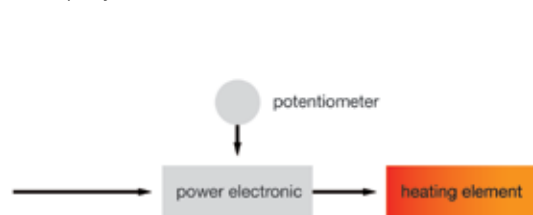

Procedures for welding floor coverings



Step 1:
Milling the groove
with the GROOVER.



Step 2:
Inserting the welding rod into
the groove with the
UNIFLOOR E hot-air welder.

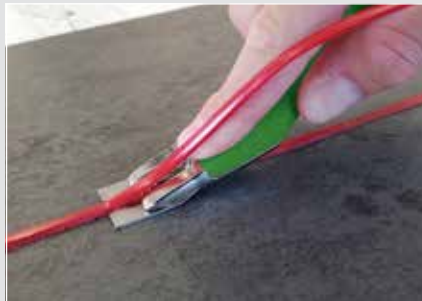

Step 3:
Removing the excess welding
rod with Quarter Moon Knife
or Trimming knife.



Step 4:
Levelling the protruding
welding rod with Quarter
Moon Knife or Trimming
knife.

UNIFLOOR 500 – automatic, efficient, quiet

The automatic floor welder, UNIFLOOR 500, is suitable for welding resilient floor coverings made of plastic and antistatic ESD floors, as well as natural coverings made of linoleum and rubber.

Automatic floor welder

UNIFLOOR 500

1



Automatic Nozzle Positioning (ANP) from Leister

Thanks to Automatic Nozzle Positioning (ANP), the hot air blower can be rotated in and out automatically by pressing the start button; the hot air blower rotates out automatically on contact with any wall.

2



Foldable pressure roller

Thanks to the fold-up pressure roller, the welding rod can be inserted easily and without tilting the UNIFLOOR 500.

3



Matching tools

A side cutter has been integrated into the transport axis, so users always have the right tool for cutting the welding rod.



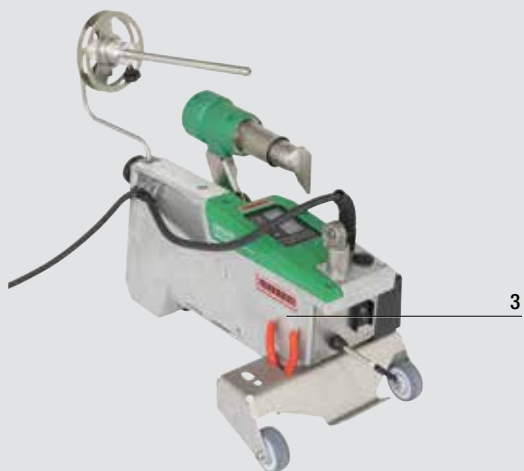

- reliable
- user-friendly
- universal
- quiet
- secure





Technical Data		
Voltage	V~	230 / 120 / 100
Power	W	2300 / 1800 / 1500
Temperature	°C	100 – 560
Frequency	Hz	50/60
Weight	kg	15.5 (incl. de-reeler and 3m cable)
Speed	m/min	0.7 – 7.5
Air flow range	%	45 – 100
Size L × W × H	mm	420 × 270 × 215
Nozzle outlet	mm	1.6 (universal use)
Conformity marking	CE	
Protection class I	⊕	

Article numbers	
169.612	UNIFLOOR 500, 230 V / 2300 W, EU plug
169.613	UNIFLOOR 500, 230 V / 2300 W, industrial plug
169.614	UNIFLOOR 500, 230 V / 2300 W, CH plug
169.615	UNIFLOOR 500, 120 V / 1800 W, US plug
169.616	UNIFLOOR 500, 120 V / 1800 W, with out plug
169.617	UNIFLOOR 500, 100 V / 1500 W, JP plug
Scope of delivery: UNIFLOOR 500 incl. de-reeler, nozzle adjustment gauge, hex key, torx key, quick guide, transportation box	

	116.798 Brass wire brush with wooden handle
	169.251 Side cutter
	170.556 Nozzle adjustment gauge
	145.582 Heating elements 230 V / 2200 W 165.176 Heating elements 120 V / 2100 W 165.179 Heating elements 100 V / 1600 W



MINIFLOOR – efficient and affordable for everyone!

The MINIFLOOR turns your hot-air hand tool into an automatic welder within seconds; increases the weld quality, facilitates work, and reduces time considerably. Its use is worthwhile from weld lengths of 1.20 m/4 ft., and thanks to its lightweight design of 5.3 kg/12 lbs., the MINIFLOOR can be transported effortlessly.

Hot-air welder

MINIFLOOR



1
Reverse compatibility: Thanks to the interchangeable inserts, even older TRIAC models can be connected without a hitch.



2
Tool-free assembly of the de-reeler: even if the de-reeler is missing you may count on hassle-free handling, as well as smooth feeding of the welding rod into the "air-slide" of the speed welding nozzle.



3
Incredibly fast: Despite its lightweight design, the MINIFLOOR offers a welding speed of about 2 m/6.5 ft per minute, nearly double the speed of manual welding.



4
The quick-lock fastening system at the clamp allows for assembling / dismantling of the TRIAC in a matter of seconds. The power supply for the hand tool is integrated in the MINIFLOOR drive unit and you have the possibility to securely fasten the cable.



5
The individually-adjustable, start-up delay of the MINIFLOOR drive unit enables modification of the startup according to individual needs. The long guide ensures outstanding precision along the seam.



6
The 51 mm/2 inches minimum distance from the wall, ensures trouble-free welding around construction pipes and L-skirts. Due to its compact height, the MINIFLOOR seamlessly welds beneath obstacles with a minimum clearance of 295 mm /12 inches.



The MINIFLOOR is ideal for short joints and small projects.



Professional, inexpensive, incredibly versatile: The new MINIFLOOR (TRIAC plus drive unit) for smart professionals.

Hot-air welder / drive unit

MINIFLOOR Drive Unit



- The only automatic welder with the possibility of connecting a hot-air hand tool in the simplest manner.
- Worthwhile from weld lengths of 1.20 m/4 ft.
- Swiss Quality you can rely on.
- Due to (51 mm/2 inches) minimum distance from the wall, there is only one required joint along the weld seam, and THAT saves time!
- Weighting in at 6.6 kg / 15 lbs (incl. TRIAC AT / nozzles) the MINIFLOOR is a lightweight and easily transportable solution.
- **NEW:** Improved directional stability!

Accessories MINIFLOOR Drive Unit

	TRIAC AT / TRIAC ST All models and part numbers can be found at chapter Hot-Air Hand Tools
	154.266 Storage case MINIFLOOR
	156.531 Carrying strap for Leister Case
	154.723 Rubber pads for TRIAC-bracket (old generation Ø 64 mm)
	100.303 Ø 5 mm, tubular nozzle, push-fit
	Speed weld nozzle, with small air-slide, push-fit on Ø 5 mm tubular nozzle 105.432 Ø 4 mm 105.433 Ø 5 mm (recommended)
	Replacement Guide wheel Guide wheel 0.5 mm 154.425 Guide wheel 2.0 mm (standard) 159.436
	163.870 Additional weight, increases the directional stability. Compatible with previous models

MINIFLOOR Drive Unit

Article No.:

- 154.330 MINIFLOOR drive unit, with EU-plug; 230 V
- 154.334 MINIFLOOR drive unit, with CH-plug; 230 V
- 154.337 MINIFLOOR drive unit, with UK-plug; 110 V
- 157.685 MINIFLOOR drive unit, with UK-plug; 230 V
- 154.338 MINIFLOOR drive unit, with AUS-plug; 230 V
- 154.335 MINIFLOOR drive unit, with US/JP-plug; 120 V
- 154.336 MINIFLOOR drive unit, without plug; 230 V

Scope of delivery: Plastic case, Roller Holder, additional weight, Rubber pad set Ø 57 – Ø 60 mm, Velcro fastener 2 pcs, quick guide

Technical Data		Drive Unit only	with TRIAC AT
MINIFLOOR			
Voltage	V~	100 – 230	100 / 120 / 230
Frequency	Hz	50 / 60	50 / 60
Power	W	5	1600
Temperature	°C		40 – 620
Air flow range	%		20 – 100%
Drive speed	m/min	0.5 – 4.5	0.5 – 4.5
Control		Closed-loop	Closed-loop/Display
Blower			Brush motor
Welding seam	mm		2.5 / 3.5
Size (L × W × H)	mm	310 × 225 × 245	495 × 225 × 295
Weight	kg	5.3	6.6 (incl. Nozzles)
Conformity marks		CE	CE
Protection class I		⊕	⊕ □

General accessories



GROOVER 500 LP – Grooving Cordless, Powerful, Reliable

Grooving – even on uneven floors of plastic or natural materials, close to the edge or along a guide rail – all in a day’s work for the GROOVER 500-LP cordless grooving machine from Leister. No more messy rat’s nests of cables and tedious searching for electric power sockets on site. Your GROOVER 500-LP lets you switch from one room to another in no time. Cordless, powerful, reliable - that’s your GROOVER 500-LP.

Grooving machine

GROOVER 500-LP

- 1  **Cordless battery operation**
with maximum flexibility
- 2  **LED light**
for illuminating the grooving area
- 3  **Side stop**
for grooving along rails
- 4  **Sensing roller**
for reliable grooving – even on uneven floors





Practical, useful and handy machine for use by flooring installer, floor layer, floor covering fitters, contractors and interior decorators.



The vacuum cleaner adapter allows to connect the tool to a vacuum cleaner. Highest suction performance is guaranteed.

Grooving machine

GROOVER 500-LP



- **General-purpose milling cutter blade** for plastic and natural floor coverings
- Particularly stable on the **three-point stand**
- **Adjustable side roller** for reliable grooving on pimped floor coverings
- **Optimized rear guide roller** for precise positioning

Technical data





Battery voltage	V ===	18
Battery capacity Li-Ion	Ah	5.0
Charger voltage	V~	230; 120
Cutting speed	rpm	5000
Blade diameter	mm	130
Groove depth adjustment	mm	0 - 6, infinitely variable
Size (L x W x H)	mm	445 x 212 x 336
Weight (incl. dust bag)	kg	5.5
Conformity mark		CE
Protection class II		□

Article No.:

- 167.451 GROOVER 500-LP, 230 V, Universal tungsten carbide tipped blade, Ø 130 x 3.5 mm, T12, parabolic profile, with CH / EU plug
- 168.171 GROOVER 500-LP, 120 V, Universal tungsten carbide tipped blade, Ø 130 x 3.5 mm, T12, parabolic profile, with US plug

Included with purchase: Grooving machine, 2x battery pack LP18/5.0, charger, vacuum cleaner adapter, dust bag black, dust pipe, union nut, hex key, quick guide, transportation box

Accessories GROOVER 500-LP

	167.024 Poly crystalline diamond tipped blade, Ø 130 x 3.5 mm, T6, conical profile
	167.025 Universal tungsten carbide tipped blade, Ø 130 x 2.8 mm, T12, parabolic profile
	167.026 Universal tungsten carbide tipped blade, Ø 130 x 3.5 mm, T12, parabolic profile
	166.642 Vacuum cleaner adapter, connection diameter 27 mm / 36 mm
	166.869 Dust bag black

GROOVER: Dust-free milling.

The GROOVER grooving machine cuts welding grooves into thick, tough floor coverings made of PVC-P, PE and linoleum. The tool glides on three rollers and cuts a uniform groove depth, even at high speeds.



Strong drive suitable for PVC, PUR and linoleum materials.

Grooving machine

GROOVER







- Cuts grooves into of all types of floor coverings
- Extremely high, two stage cutting speeds
- Adjustable guide roller for tracking accuracy
- Reduced dust particles when used with dust bag
- Cutting close to the edge possible

Technical Data

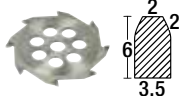
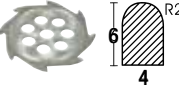
Voltage	V~	120 / 230
Power	W	350 / 700 (2 levels)
Cutting speeds	rpm	Level 1: 14 500 (350 W) Level 2: 18 500 (700 W)
Groove depth adjustment	mm	0 – 4
Size (L x W x H)	mm	240 x 205 x 255
Weight	kg	6.7 (with 3 m cable)
Conformity marking		CE
Approval mark		Ⓢ
Protection class II		□

Accessories GROOVER

	102.401 Ø 110 x 3.5 mm, tungsten carbide-tipped blade, trapezium profile
	102.402 Ø 110 x 4 mm, tungsten carbide-tipped blade, round profile
	102.403 Ø 110 x 2.8 mm, tungsten carbide-tipped blade, round profile
	102.405 Ø 110 x 3.5 mm, tungsten carbide-tipped blade, round profile
	102.406 Ø 110 x 3.5 mm, diamond cutting blade, semi-round profile
	126.448 Storage case (included with purchase)

Article No.:

- 108.393 GROOVER 230 V, tungsten carbide tipped blade Ø 110 x 3.5 mm, trapezium profile, with Euro plug, storage case
- 111.032 GROOVER 230 V, tungsten carbide tipped blade Ø 110 x 3.5 mm, round profile, with Euro plug, storage case
- 108.397 GROOVER 120 V, tungsten carbide tipped blade Ø 110 x 3.5 mm, trapezium profile, with UK plug yellow, storage case
- 112.238 GROOVER 230 V, tungsten carbide tipped blade Ø 110 x 3.5 mm, trapezium profile, with UK plug, storage case
- 108.395 GROOVER 120 V, tungsten carbide tipped blade Ø 110 x 3.5 mm, trapezium profile, with US plug polarized, storage case
- 109.930 GROOVER 230 V, tungsten carbide tipped blade Ø 110 x 3.5 mm, trapezium profile, with AUS plug, storage case

GROOVY: Lightweight and handy.

The new “GROOVY” gouging tool is the lightweight, handy tool for the experienced layer of plastic floor coverings made of PVC or linoleum. Its ergonomic shape makes it possible to achieve the desired groove width and depth up to the connecting walls, defined and clean-cut, with little pressure.

Gouging tool

GROOVY



- Lightweight and handy
- Groove preparation without milling
- Clean transition from machine-milled groove to the closure
- Ideal for surfaces that are small and difficult to access
- Precise work thanks to roller guide
- Groove gouging up to connecting walls
- Adjustable groove depth

Technical Data

Groove width	mm	3.5
Groove depth	mm	0.5 – 2.5
Size (L x W x H)	mm	180 x 42 x 92
Weight	kg	0.290

Article number:

150.809 Gouging tool “GROOVY” 3.5 mm for elastic floor coverings

Accessories GROOVY

	151.394 Protective plug
	150.815 Blade Ø 3.5 mm
	154.717 Blade Ø 2.5 mm
	Replacement Guide wheel
	154.279 Guide wheel 1.8 mm (standard)
	151.453 Guide wheel pointed

Ideal for surfaces that are small and difficult of access



Executing clean grooves up to connecting walls



Precise and simple guidance thanks to integrated guide rollers



General accessories

	100.303 107.144	Tubular nozzle Ø 5 mm, 15° angled, push-fit (TRIAC) Ø 5 mm, 15° angled, push-fit (HOTJET)		150.809	Gouging tool "GROOVY" 3.5 mm for elastic floor coverings
	105.576 131.867	Tubular nozzle Ø 5 mm, 90° angled, push-fit (TRIAC) Ø 5 mm, 90° angled, push-fit (HOTJET)		150.815 154.717	Blade Ø 3.5 mm Blade Ø 2.5 mm
	105.567 105.575	Tubular nozzle Ø 5 mm, 150 mm, straight (HOTJET) Ø 5 mm, 100 mm, straight (TRIAC)		157.544	Leister Universal scissors 260 mm with special shaft grinding
	105.431 105.432 105.433	Speed weld nozzle 3 mm, with small air-slide, push-fit on Ø 5 mm tubular nozzle 4 mm, with small air-slide, push-fit on Ø 5 mm tubular nozzle 5 mm, with small air-slide, push-fit on Ø 5 mm tubular nozzle		117.000	Trimming knife with 0.6 mm spacer for vinyl and linoleum with 5 spare blades included
	107.139 107.137	Speed weld nozzle 4.5 × 12 mm for fillet weld, push-fit on Ø 5 mm tubular nozzle 8 mm welding, push-fit on Ø 5 mm tubular nozzle		117.005	5 spare blades
	159.848 160.550	Speed weld nozzle 5 mm, with small air-slide, curved, push-fit on 5 mm tubular nozzle 3 mm, with small air-slide, curved, push-fit on 5 mm tubular nozzle		117.007	1 universal spacer 0.6 mm
	106.992 106.993	Speed welding nozzle, push-fit on Ø 5 mm tubular nozzle 5.7 mm, profile A 7 mm, profile B		106.969	Quarter Moon Knife including leather case, 100 mm stainless steel blade
	165.937	Smoothing Nozzle push-fit on Ø 5 mm tubular nozzle		122.541	Trimming guide, to use with spatula (106.969)
	107.270	Wide slot nozzle 150 × 12 mm, push-fit (ELECTRON ST)		137.855	Leister cutter with four spare blades
	142.281	Scraper nozzle (ELECTRON ST)		138.902	Hooked blade for LEISTER-cutter (10 dispenser with 10 pcs=100 pcs)
	148.933	Protective tube (ELECTRON ST)		138.539	Straight-edge blade for LEISTER-cutter (10 dispenser with 10 pcs = 100 pcs)
	151.068	Tool stand (ELECTRON ST) (recommended)		116.798	Brass brush
	106.970 106.971	Pressure roller for welding rods Ø 4 – 5 mm for welding rods Ø 2 – 4 mm		142.647	Brass brush Ø 3 mm
	106.966 106.968	Hand grooving tool Spare blades for hand grooving tool		160.353	Cable cord roller 25 m PUR 5 × 2.5 mm ² , with 1 × CEE 400 V and 2 × EU socket 230 V
				161.152	Cable cord roller 25 m PUR 5 × 2.5 mm ² , with 1 × CEE 400 V and 2x T23 CH socket 230 V
				161.207	Cable cord roller 25 m PUR 5 × 2.5 mm ² , with 1 × CEE 400 V and 2 × Typ E with ground pin socket 230 V
				164.048	Cable cord roller 45 m, 4 × 230 V, EU socket
				160.015	Cable extension cord 15 m PUR 5 × 2.5 mm ² , with CEE 400 V plug
				159.239	Cable extension cord 15 m PUR 3 × 2.5 mm ² , with EU plug 230 V



Leister. We know how.

Leister is a world leader in the industry and one of the pioneers in the fields of hot-air, hot-wedge and extrusion welding processes.

Leister Technologies AG manufactures high-quality welding machines for demanding work for all industries, in which plastic is processed.

Know-how

Welding Methods

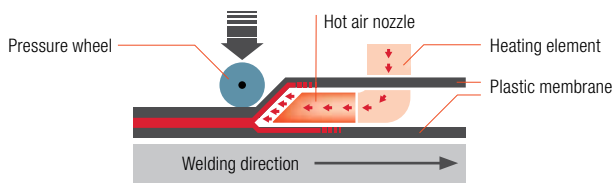

Hot-air welding

Hand tools, automatic welders, stationary welding machines



In hot gas welding, the thermal energy is controlled. Heated air is fed into the workpiece and the required amount of pressure is exerted onto the wheels.

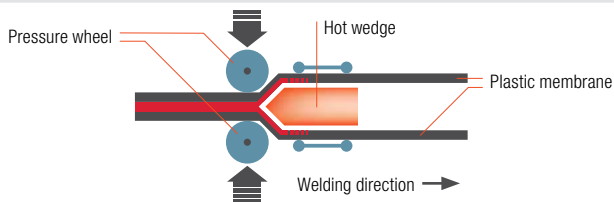

Hot-wedge welding

Wedge welders



The process where the wedge is heated directly by heating cartridges. The generated heat is transferred directly onto the workpiece. This method also is suitable for thicker materials.

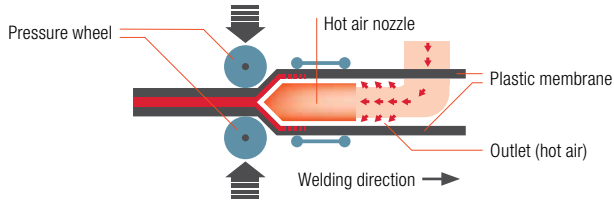

Combi-wedge welding

Combi-wedge welding machines



When Combi-wedge welding (combination of a heated wedge and hot air), preheating of the air and the actual welding process is carried out over a wedge. The preheated air also takes partial cleaning of the workpieces.

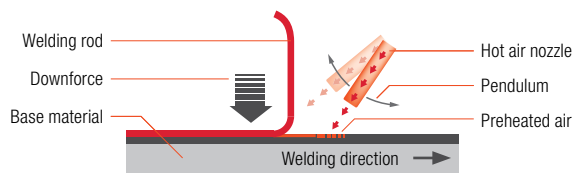

Pendulum Welding

Hand tools



Pendulum welding requires a welding rod similar to the base material. Both surfaces are then heated using hot air. Using an up and down, pendulum-like motion and consistent downward pressure, the two are joined.

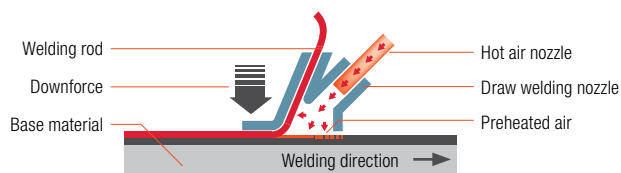

Draw Welding (Speed Welding)

Hand tools



This welding method requires the use of a speed welding nozzle. Preheat the surfaces to the appropriate temperature. The surfaces are plasticized by hot air and joined under consistent downward pressure.

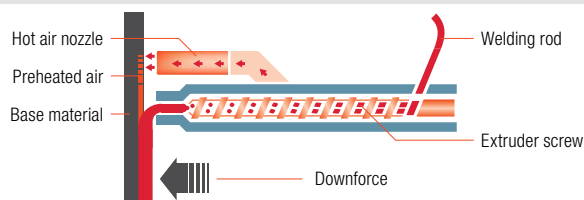

Extrusion Welding

Extrusion Welders (FUSION & WELDPLAST)



In extrusion welding, the substrate is preheated with hot air and connected by adding the extrudate. The welding rod is fed into the heater barrel and the plast is processed by the extruder screw.





Plastic welding with Leister

In plastic welding, thermoplastic materials are joined through the combination of thermal energy, pressure and welding speed. Combined, these key factors are the main considerations in the welding of many types of applications including: roofing, civil engineering, tunneling, tents & tarps, signs & banners, floor coverings, vehicle repairs, plastic fabrication and many more.

Know-how

Weld Types / Weld Geometries

Welding without filler material

-  Special applications
-  Roofing
-  Technical Textiles
-  Civil Engineering / GEO
-  Plastic Fabrication
-  Flooring

Overlap

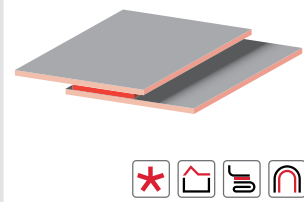

Hem

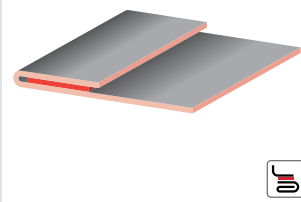

Tape

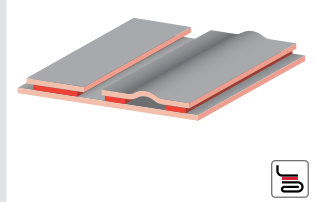

Double seam w/test channel

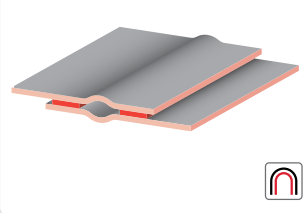

Keder / Piping

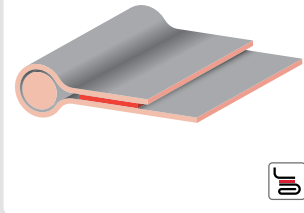

Pole pockets

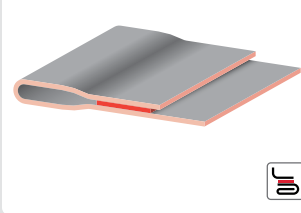

Antivandalism

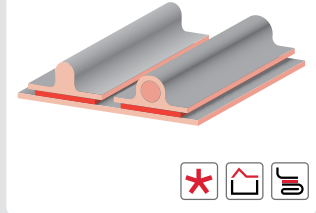

Welding with additional material

Overlap seam

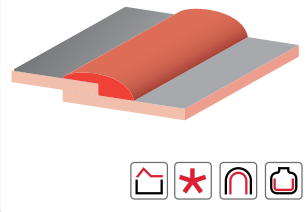

Floor seam

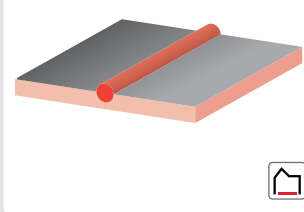

V-seam

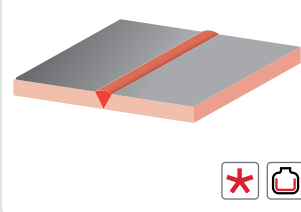

X-seam

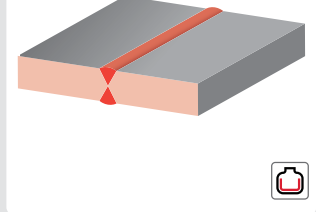

Outside corner seam

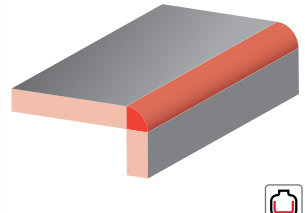

Fillet weld seam

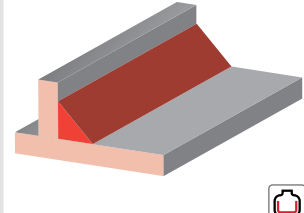

Corner seam

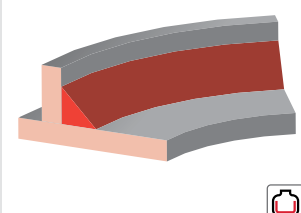

Legal Information

Contents

We take the greatest care in presenting correct, complete and up-to-date information. However, we can assume no responsibility whatsoever for the information offered in this catalog. We reserve the right to modify or update all information at any time without prior notice.

Copyrights and trademarks

All text, images, graphics as well as their arrangement are subject to copyright protection and other laws on the protection of intellectual property. The reproduction, alteration, transmission or publication of this catalog in part or in its entirety, except for personal, non-commercial use, is prohibited in all possible forms.

All the marks featured in this catalog (protected all brand marks, logos and business names) are the property of Leister Technologies AG or third parties and may not be used, permanently downloaded, copied or distributed without prior written consent.

Specifications

Specifications are subject to change at any time without prior notice.

© Copyright by Leister.

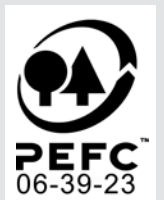

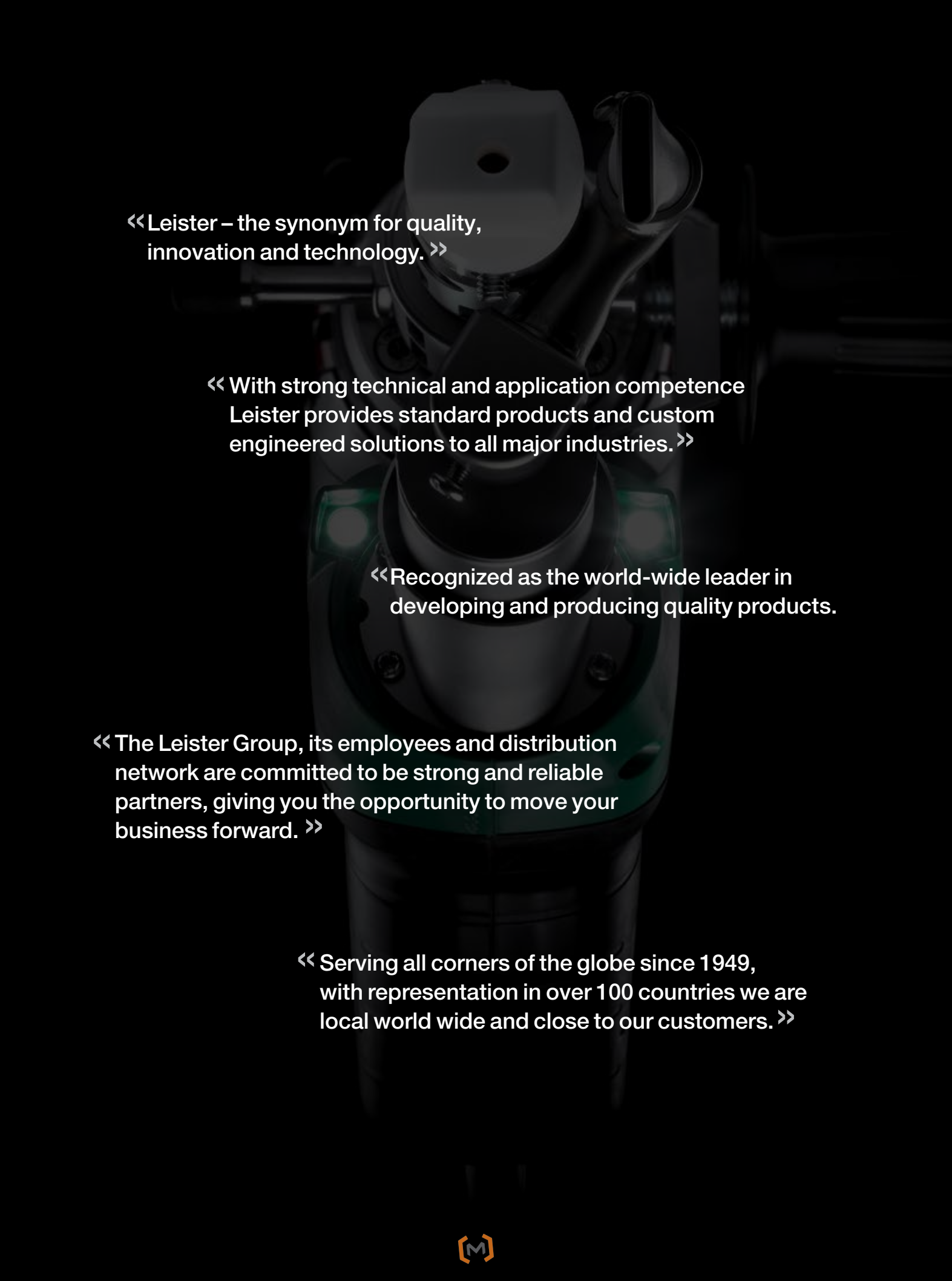

«Leister – the synonym for quality,
innovation and technology. »»

« With strong technical and application competence
Leister provides standard products and custom
engineered solutions to all major industries. »»

«Recognized as the world-wide leader in
developing and producing quality products.

« The Leister Group, its employees and distribution
network are committed to be strong and reliable
partners, giving you the opportunity to move your
business forward. »»

« Serving all corners of the globe since 1949,
with representation in over 100 countries we are
local world wide and close to our customers. »»



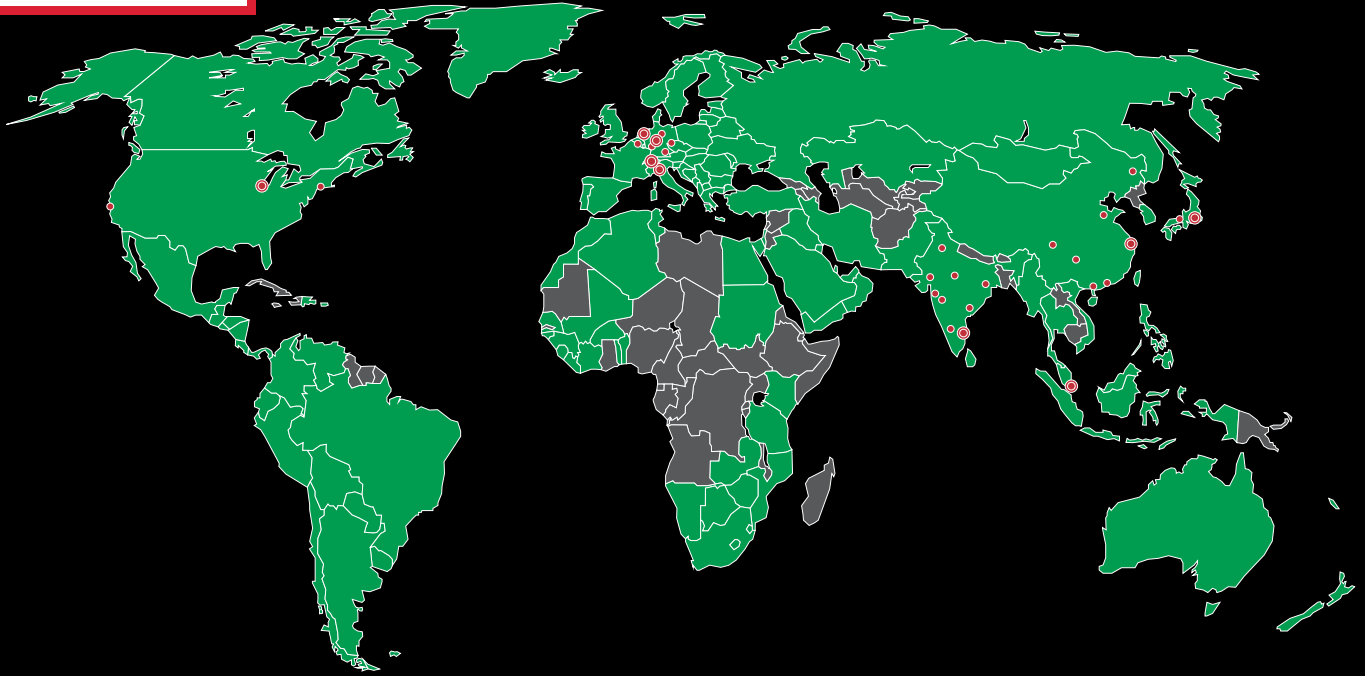

© Copyright by Leister, Switzerland

Your Leister Sales and Service Center:

cunha  mendes cunha, lda
Equipamentos Industriais

email:cmc@cmc.pt

web:www.cmc.pt



Swiss Made. Leister Technologies AG is an ISO 9001 certified enterprise.