



















PROMODAY 2025

PORTUGAL € IVA ÑAO INCLUIDA



cunha  mendes cunha, lda
Equipamentos Industriais

04	CHAVES DE APERTO	
08	CHAVES DE CAIXAS	
14	CHAVES DE FENDA E ALICATES	
18	ELETRÓNICA E ELETROTÉCNICA	
20	CHAVES DINAMOMETRICAS	
22	FERRAMENTAS DE CORTE	
24	MANUTENÇÃO GENERAL	
32	ILUMINAÇÃO	
42	POWER TOOLS	
48	EXTRACTORES	
50	FERRAMENTAS DE AR	
58	CARROS E BANCOS	
104	MOBÍLIA TÉCNICA	
118	MOBILIÁRIO PARA VANS	
124	AUTOMOTIVE	
144	PROFESSIONAL EQUIPMENT	



CHAVES DE APERTO



FG 600/A

INDUSTRIAL

NOVA CHAVE POLIGONAL DE BOCA/LUNETETA

DESIGN DE CABEÇA OTIMIZADO
Para uma elevada força de fixação

ALTO DESEMPENHO
Atinge valores de binário duas vezes superiores ao padrão

CABEÇA POLIGONAL DESLOCADA
Inclinado 15° para aceder às porcas e parafusos embutidos na superfície de trabalho e proteger a mão do utilizador



FG 600A/SC16

245,00€

149,00€

JOGOS CHAVES DE BOCA/LUNETAS POLIGONAIS - INDUSTRIAL

Conteúdo: 6, 7, 8, 10, 12, 13, 14, 16, 17, 19, 21, 22, 24, 27, 30, 32mm

FG 600A/SC25

405,00€

229,00€

JOGOS CHAVES DE BOCA/LUNETAS POLIGONAIS - INDUSTRIAL

Conteúdo: 6, 7, 8, 10, 12, 13, 14, 15, 16, 17, 18, 19, 20, 21, 22, 23, 24, 25, 26, 27, 28, 30, 32

NEW



FG 600/SC16

232,00€

139,00€

JOGOS CHAVES DE BOCA/LUNETAS POLIGONAIS

Conteúdo: 6, 7, 8, 10, 12, 13, 14, 16, 17, 19, 21, 22, 24, 27, 30, 32mm

FG 600/SC25

385,00€

209,00€

JOGOS CHAVES DE BOCA/LUNETAS POLIGONAIS

Conteúdo: 6, 7, 8, 10, 12, 13, 14, 15, 16, 17, 18, 19, 20, 21, 22, 23, 24, 25, 26, 27, 28, 30, 32mm



FG 602/SC13

150,00€

95,00€

JOGOS CHAVES DE BOCAS

Conteúdo: 6x7, 8x9, 10x11, 12x13, 14x15, 16x17, 18x19, 20x22, 21x23, 24x26, 25x28, 27x29, 30x32mm



**NOVA CHAVE
POLIGONAL
DE BOCA/LUNETA
TWISTER**

NEW

A nova chave TWISTER da Fasano Tools tem um design único e inovador: a rotação do cabo faz com que o garfo e a cabeça poligonal fiquem perpendiculares entre si, de modo a que o utilizador segure a chave pelo lado plano, tendo mais área de superfície.

Isto permite que a força de aperto seja aumentada em mais de 20% em comparação com os interruptores comuns, reduzindo significativamente a tensão e a fadiga das mãos durante a utilização.

+ FORÇA DO TORQUE



FG 600TW/S12

~~190,00€~~

115,00€

JOGO DE CHAVES POLIGONALES DE BOCA/LUNETA TWISTER

Conteúdo: 8, 9, 10, 11, 12, 13, 14, 15, 16, 17, 18, 19mm

NEW



FG 600XL/SC11

~~368,00€~~

219,00€

JOGO DE CHAVES DE LUNETA DUPLAS DIREITAS, SÉRIE EXTRALONGA

Conteúdo: 8x10, 10x12, 11x13, 12x14, 13x15, 14x17, 16x18, 17x19, 20x22, 21x23, 22x24mm

NEW



FG 615/SC8

~~116,00€~~

69,90€

JOGOS DE CHAVES DE LUNETA CON CURVADURA

Conteúdo: 6x7, 8x9, 10x11, 12x13, 14x15, 16x17, 18x19, 20x22mm



FG 614C/S8

~~265,00€~~

139,00€

JOGO DE CHAVES DE CAIXA COM ARTICULAÇÃO DUPLA

Conteúdo: 6x7, 8x9, 10x11, 12x13, 14x15, 16x17, 18x19, 20x22 mm



FG 180/SP9

~~216,00€~~

129,00€

JOGOS CHAVES DE LUNETA ABERTA

Conteúdo: 8x10, 10x11, 11x13, 12x14, 17x19, 19x22, 24x27, 30x32mm



FG 613/S11

~~225,00€~~

139,00€

JOGO CHAVES DE CACHIMBO HEXAGONAIS-POLIGONAIS

Conteúdo: 6, 7, 8, 10, 11, 12, 13, 14, 17, 19, 22mm





FG 623H/S6

132,00€

79,20€

JOGO DE CHAVES EM T HEXAGONAIS COM VEIO FIXO

Conteúdo: 2,5, 3, 4, 5, 6, 8mm

FG 623H/S8

186,00€

119,00€

JOGO DE CHAVES EM T HEXAGONAIS COM VEIO FIXO

Conteúdo: 2, 2,5, 3, 4, 5, 6, 8, 10mm

FG 623H/S14

375,00€

€239,00€

JOGO DE CHAVES EM T HEXAGONAIS COM VEIO FIXO

Conteúdo: 2, 2,5, 3, 3,5, 4, 4,5, 5, 6, 7, 8, 9, 10, 12, 14mm



NEW



NOVA CHAVE T SEXTAVADA

NEW

INDUSTRIAL



DESEMPENHO E ERGONOMIA

A nova chave com cabo em T da Fasano Tools foi concebida para proporcionar um elevado binário. O cabo fixo e o aço especial Cromo Vanádio garantem um elevado nível de resistência.

A ergonomia foi significativamente melhorada graças ao novo design, enquanto as pontas polidas até 8 mm permitem trabalhar com a máxima precisão.

AÇO CROMO VANÁDIO

FG 621H/S8

139,00€

85,00€

JOGOS CHAVES EM T COM PONTAS

Conteúdo: 2, 2,5, 3, 3,5, 4, 5, 6, 8mm

FG 621H/S8C

152,00€

89,00€

JOGOS CHAVES EM T COM PONTAS CON VARILLA DESLIZANTE

Conteúdo: 2, 2,5, 3, 4, 5, 6, 8, 10mm

FG 621H/S14

298,00€

179,00€

JOGOS CHAVES EM T COM PONTAS CON VARILLA DESLIZANTE

Conteúdo: 2, 2,5, 3, 3,5, 4, 4,5, 5, 6, 7, 8, 9, 10, 12, 14mm



FG 618/S7B

265,00€

€159,00€

JOGOS CAIXA HEXAGONAIS COM CARDAN E CABO EM T

Conteúdo: 7, 8, 10, 12, 13, 14, 17mm

FG 618/S7

293,00€

€179,00€

JOGOS CAIXA HEXAGONAIS COM CARDAN E CABO EM T

Conteúdo: 8, 10, 11, 13, 14, 17, 19mm

FG 618/S10

418,00€

249,00€

JOGOS CAIXA HEXAGONAIS COM CARDAN E CABO EM T

Conteúdo: 8, 10, 11, 12, 13, 14, 15, 16, 17, 19mm



FG 39/S4

~~180,00€~~

109,00€

JOGO DE 4 CHAVES DE BÚSSOLA COM PONTAS INTERCAMBIÁVEIS

Conteúdo: 1.5/2.5mm, 2.0/3.0mm, 3.0/5.0mm, 4.0/6.0mm, 5.0/7.0mm, 6.0/8.0mm, 8.0/10.0mm, 8.0/12.0mm



FG 605/ST11-B

~~238,00€~~

145,00€

JOGO DE CHAVES DE BOCA/LUNETETA CON SISTEMA DE ROQUETE REVERSÍVEL

Conteúdo: 8, 9, 10, 11, 12, 13, 14, 15, 16, 17, 19mm



Anel de aço integrado para segurar o parafuso.

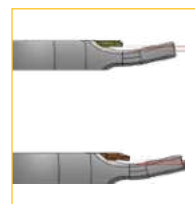

Banco de corrida traseiro com perna angular por baixo para maior espaço de manuseamento

FG 606/SP9

~~135,00€~~

85,00€

JOGO DE CHAVES COMBINADAS NÃO REVERSÍVEIS

Conteúdo: 8, 10, 11, 12, 13, 14, 15, 17, 19mm



FG 615A/S6

~~130,00€~~

75,00€

JOGO DE 6 CHAVES DE PORCAS DUPLAS COM ROQUETE UNIVERSAL REVERSÍVEL DE 90 DENTES

Conteúdo: 8x9, 10x11, 12x13, 14x15, 16x18, 17x19mm



FG 605/SC15

~~265,00€~~

159,00€

JOGO DE CHAVES COMBINADAS REVERSÍVEL

Conteúdo: 6, 7, 8, 9, 10, 11, 12, 13, 14, 15, 16, 17, 18, 19, 22mm



FG 610FL/SP11

~~295,00€~~

179,00€

JOGO DE CHAVES COMBINADAS ESSÍVEL

Conteúdo: 8, 10, 11, 12, 13, 14, 15, 16, 17, 18, 19mm



FG 622A/S2

~~80,00€~~

49,00€

JOGO DE CHAVES DE CATRACA UNIVERSAL 2 SÉRIES EXTRA LONGAS

Conteúdo: 21x22, 24x27 mm





CHAVES DE CAIXAS



FG 624/S25

~~90,00€~~

49,90€

JOGO 25 FERRAMENTAS COM ATAQUE DE 1/4"



CONTENTE

	FG 624/E	6,8,10,11,12,13mm
	FG 624/CR14	
	FG 89/38PI1	1/4" x 1/4"
	FG 85/25PH	1, 2, 3
	FG 85/25PZ	1, 2, 3
	FG 85/25F	4, 5, 6, 7
	FG 85/25TX	10, 15, 20, 25, 27, 30, 40



FG 624/S25A

~~85,00€~~

49,90€

JOGO 25 FERRAMENTAS COM ATAQUE DE 1/4"



CONTENTE

	FG 624/E	5, 6, 8, 10, 11, 13mm
	FG 624/MCH14	
	ADATTATORE	1/4" x 1/4"
	FG 85/25PH	1, 2, 3
	FG 85/25PZ	1, 2, 3
	FG 85/25F	3, 5
	FG 85/25H	4, 5, 6
	FG 85/25TX	10, 15, 20, 25, 30, 40



FG 624/S45





~~210,00€~~

129,00€

JOGO 45 FERRAMENTAS COM ATAQUE DE 1/4"



CONTENTE

	FG 624/E	4, 5, 6, 7, 8, 9, 10, 11, 12, 13, 14mm
	FG 624/CR14	
	FG 624/ES14	
	FG 624/PA	50, 100
	FG 624/PRF150	
	FG 624/SN14	
	FG 624/GR14C	
	FG 148/H, FG 148/TX, FG 148/PH, FG 148/F	1,5-10, 8-40, 1-4, 1-5



FG 624B/S80

~~200,00€~~

119,00€

JOGO 80 FERRAMENTAS 3/8"



CONTENTE

	FG 624/B	8,9,10,11,12,13,14,15,16,17,18,19, 21,22,23
	FG 624B/L	8,10,13,17,19
	FG 624/CR38	
	FG 625/SN38	
	FG 149/H	3,4,5,6,7,8,10
	FG 149/TX	9,10,15,20,25,27,30,40
	FG 624/ES38	
	FG 624B/PA	75,125,150,250
	FG 600/B8	8,10,13,15,17,19
	FG 89/50PI2	3/8"x1/4"
	FG 85/25PH	1,2,3
	FG 85/25PZ	1,2,3
	FG 85/25SL	3,4,4,5,5,5,5,6,6,5
	FG 85/H	1,5,2,2,5,3,4,5,6
	FG 85/25T	9,10,15,20,25,27,30,40
	FG 88/60PI2	



FG 625/S27





~~190,00€~~

109,00€

JOGO DE 27 FERRAMENTAS DE 1/2"



CONTENTE

	FG 625/A	8,9,10,11,12,13,14,15,16,17,18,19,20, .21,22,23,24,25,26,27,30,32
	FG 625/CR12	
	FG 625/SN12	
	FG 625/ES12	
	FG 625/PA	125,250



FG BEST 108

270,00€

139,00€

JOGO DE 108 FERRAMENTAS 1/4" Y 1/2"



CONTENTE

	FG 625/A	10,11,12,13,14,15,16,17,18,19,20,21, 22,23,24,27,30,32
	FG 624/E	4,4.5,5.5,6,7,8,9,10,11,12,13,14
	FG 625L/A	14,15,17,19,22
	FG 624E/L	6,7,8,9,10,11,12,13
	FG 625/TX	10,11,12,14,16,18,20,24
	FG 624/TX	4,5,6,7,8
	FG 181/B	16,21
	FG 624/CR14	
	FG 625/CR12	

	FG 625/SN12	
	FG 624/SN14	
	FG 625/ES12	
	FG 624/ES14	
	FG 624/GR14	
	FG 625/PR	125
	FG 624/PR	50,100
	FG 87/AD	
	FG 139/D	1.5,2,2.5
	FG 147/	PH (1,2), PZ (1,2), SL (4, 5.5, 6.5), H (4,5.5,6.5), TX (10,15,20,25,30)
	FG 85/	PH (3,4), PZ (3,4), SL (8,10,12), H (7,8,10,12,14), TX (40,45,50,55,60)



FG BEST 171

400,00€

199,00€

JOGO DE 171 FERRAMENTAS 1/4", 3/8" Y 1/2"



CONTENTE

	FG 625/A	10,11,12,13,14,15,16,17,18,19,20,21, 22,23,24,27,30,32
	FG 624/B	10,11,12,13,14,15,16,17,18,19
	FG 624/E	4,4.5,5.5,6,7,8,9,10,11,12,13,14
	FG 625L/A	16,17,18,19,22
	FG 624B/L	10,11,12,13,14,15
	FG 624E/L	4,5,6,7,8,9,10
	FG 625/TX	20,24
	FG 624B/TX	10,11,12,14,16,18
	FG 624/TX	4,5,6,7,8
	FG 181/B	16,21

	FG 624/CR14	
	FG 624/CR38	
	FG 625/CR12	
	FG 624/SN14	
	FG 624/SN38	
	FG 625/SN12	
	FG 625/ES12	
	FG 624/ES14	
	FG 624/GR14	
	FG 625/PR125	125
	FG 624B/PR125	125
	FG 624/PR50,100	50,100
	FG 87/AD	
	FG 139/D	1,1.5,2,2.5,3,4,4.5,5
	FG 147/	PH (0,1,2), PZ (0,1,2), SL (4,5.5,6.5,7), H (3,4,5), TX (8-30), RTX (8-30)
	FG 85/	PH (3,4), PZ (3,4), SL (8,10,12), H (7,8,10,12,14), TX (40-50), TT (10-45), M (5-9)



FG 625/S110

~~480,00€~~





259,00€

JOGO DE 110 FERRAMENTAS DE 1/4" E 1/2"



CONTENTE

	FG 625/A	8,9,10,11,12,13,14,15,16,17,18,19,20,21,22,23,24,25,26,27,30,32
	FG 624/E	4,5,6,7,8,9,10,11,12,13,14
	FG 624/CR14	
	FG 625/CR12	
	FG 625/SN12	
	FG 624/SN14	
	FG 625/ES12	
	FG 624/ES14	
	FG 624/GR14C	
	FG 625/PA	125, 250
	FG 624/PA	50, 100
	FG 89/38PI1	1/4"x1/4"
	FG 85/25PH	1,2,3
	FG 85/25SL	3,4,4.5,5,5.5,6,6.5
	FG 85/25PZ	1,2,3
	FG 85/H	1.5,2,2.5,3,4,5,6
	FG 85/25T	9,10,15,20,25,27,30,40
	FG 88/60P12	

	FG 139/B	
	FG 48/L	
	FG 49	
	FG 600/B	8,10,11,12,13,14,15,17,19
	FG 22	3x75, 4x100, 5.5x100
	FG 22/PH	0x60, PH1x80, PH2x100
	FG 59XT/160	
	FG 63XT/160	
	FG 58/B240	
	FG 132/H500	
	FG 79/SP	
	FG 93/M24	
	FG 44/MT5	



FG 150TX/S32

~~196,00€~~

125,00€

JOGO 32 CHAVES DE PONTA TORX 1/2"



CONTENTE

	FG 150/TX	20 - 70
	FG 150L/TX	20 - 70
	FG 150XL/TX	40 - 70
	FG 150XXL/TX	40 - 70



FG 150M/S26

180,00€

109,00€

JOGO 26 CHAVES DE PONTA XZN 1/2"



CONTENTE

	FG 150/M	5 - 16
	FG 150L/M	5 - 16
	FG 150XL/M	5 - 14
	FG 150XXL/M	8 - 14



FG 150H/S30

200,00€

119,00€

JOGO 30 CHAVES DE PONTA HEXAGONAIS



CONTENTE

	FG 150/H	5 - 19
	FG 150L/H	5 - 13
	FG 150XL/H	5 - 14
	FG 150XXL/H	5 - 12



FG 629A/S15





620,00€

339,00€

JOGO CAIXAS HEXAGONAIS 3/4"



CONTENTE

	FG 629/A	19,22,24,27,30,32,36,41,46,50,60mm
	FG 629/CR34	
	FG 629/SN34	
	FG 629/ES34	
	FG 629/PR200	



FG 629B/S15





620,00€

339,00€

JOGO CAIXAS POLIGONAIS 3/4"



CONTENTE

	FG 629/B	19,22,23,27,30,32,36,41,46,50,60mm
	FG 629/CR34	
	FG 629/SN34	
	FG 629/ES34	
	FG 629/PR200	

FG 152/RTXS10

165,00€

99,00€

JOGO DE 10 CHAVES DE PONTA TORX

Conteúdo: RTX20, RTX25, RTX27, RTX30, RTX40, RTX45, RTX50, RTX55, RTX60, RTX70



FG 629C/S10

310,00€

169,00€

JOGO 10 CHAVES DE CAIXA DE IMPACTO HEXAGONAIS DA 3/4" EM CAIXA DE ACCIAIO

Conteúdo: 17,19,22,24,27,30,32,36,41,46mm



FG 152RH/S9

125,00€

69,00€

JOGO DE 9 CHAVES DE PONTA HEXAGONALES

Conteúdo: RH5, RH6, RH7, RH8, RH10, RH12, RH14, RH17, RH19



FG 152RM/S9

125,00€

69,00€

JOGO DE 9 CHAVES DE PONTA XZN - 1/2"

Conteúdo: RM5, RM6, RM8, RM9, RM10, RM12, RM14, RM16, RM18



FG 630A/S14

870,00€

499,00€

JOGO 14 CHAVES DE CAIXA DE IMPACTO HEXAGONAIS 1" EM CAIXA DE ACCIAIO

Conteúdo: 24,27,30,32,33,34,36,38,41,46,50,55,60,65mm



FG 625AM/S3

49,50€

29,90€

JOGO 3 ADAPTADORES MAGNÉTICOS SUPER PLANOS

Conteúdo: 1/4"x3/8", 3/8"x1/2", 1/2"x3/4"



CHAVE
BÚSSOLA
1/2"
HEXAGONAL
REFORÇADO



EXTRAPLANO

FG 628/S6

95,00€

55,00€

JOGO DE 6 LLAVES DE VASO HEXAGONALES REFORZADAS PLANO - CONEXIÓN 1/2"

Conteúdo: 24,27,30,32,33,34,36,38,41,46,50,55,60,65mm



FG 628/S12

130,00€

79,00€

JOGO DE 12 LLAVES DE VASO HEXAGONALES REFORZADAS PLANO - CONEXIÓN 1/2"

Conteúdo: 24,27,30,32,33,34,36,38,41,46,50,55,60,65mm





CHAVES DE FENDA E ALICATES

FG 22/S6

~~36,00€~~

21,90€

JOGO DE CHAVES PARA PARAFUSOS DE PERFIL DE FENDA E PHILLIPS

Conteúdo: 3x75, 4x100, 5.5x100, PH0x60, PH1x80, PH2x100



FG 22/S8

~~51,00€~~

27,90€

JOGO DE CHAVES PARA PARAFUSOS DE PERFIL DE FENDA E PHILLIPS

Conteúdo: 3x75, 4x100, 5.5x100, 6.5x30, PH0x60, PH1x80, PH2x100, PH2x30



FG 22/S8B

~~58,00€~~

31,90€

JOGO DE CHAVES PARA PARAFUSOS DE PERFIL DE FENDA E PHILLIPS

Conteúdo: 2.5x75, 3.5x100, 4x100, 6.5x150, 8x150, PH0x60, PH1x80, PH2x150



FG 22/S12

~~90,00€~~

49,90€

JOGO DE CHAVES PARA PARAFUSOS DE PERFIL DE FENDA E PHILLIPS

Conteúdo: 2.5x60, 3x75, 4x100, 5.5x150, 6.5x150, 8x150, 4x30, PH0x60, PH1x80, PH2x100, PH3x150, PH1x30



FG 22TX/S6

~~70,00€~~

36,90€

JOGO CHAVES DE FENDA PARA PARAFUSOS DE PERFIL TORX

Conteúdo: TX10, TX15, TX20, TX25, TX27, TX30



FG 22RTX/S8

~~94,50€~~

49,90€

JOGO CHAVES DE FENDA PARA PARAFUSOS DE PERFIL TAMPER RESISTANT TORX

Conteúdo: RTX10, RTX15, RTX20, RTX25, RTX27, RTX30, RTX40, RTX45



FG 22FX/S10

~~149,00€~~

89,90€

JOGO CHAVES DE CAIXA COM HASTE RÍGIDA

Conteúdo 5, 5.5, 6, 7, 8, 9, 10, 11, 12, 13 mm



FG 139/B

~~16,50€~~

9,90€

JOGO 10 CHAVES MACHO HEXAGONAIS – SÉRIE CURTA

Conteúdo: 1.5, 2, 2.5, 3, 4, 5, 5.5, 6, 8, 10 mm



FG 139

~~36,00€~~

22,90€

JOGO 12 CHAVES MACHOS HEXAGONAIS COM EXTREMIDADE ESFÉRICA – SÉRIE CORTA

Conteúdo: 1.5, 2, 2.5, 3, 4, 4.5, 5, 5.5, 6, 7, 8, 10 mm



CABEÇA DE BOLA

FG 139/C

~~24,50€~~

13,90€

JOGO 10 CHAVES MACHO HEXAGONAIS – SÉRIE LONGA

Conteúdo: 1.5, 2, 2.5, 3, 4, 5, 5.5, 6, 8, 10 mm



FG 139/L

~~41,50€~~

24,90€

JOGO 12 CHAVES MACHOS HEXAGONAIS COM EXTREMIDADE ESFÉRICA – SÉRIE LONGA

Conteúdo: 1.5, 2, 2.5, 3, 4, 4.5, 5, 5.5, 6, 7, 8, 10 mm



CABEÇA DE BOLA

FG 139/LM

~~54,00€~~

32,90€

JOGO 10 CHAVES MACHO HEXAGONAIS COM IMPRONTA ESAGONALE SFERICA

Conteúdo: 1.5, 2, 2.5, 3, 4, 5, 6, 7, 8, 10 mm



Extremo magnético

FG 139/IN

~~38,00€~~

22,90€

JOGO 13 CHAVES MACHO HEXAGONAIS COM EXTREMIDADE ESFÉRICA – SÉRIE EM POLEGADAS

Conteúdo: 0.05 - 3/8"



CABEÇA DE BOLA



FG 138/BP

~~60,00€~~

35,90€

JOGO 9 CHAVES MACHO TORX COM EXTREMIDADE ESFÉRICA

Conteúdo: TX8, 10, 15, 20, 25, 27, 30, 40, 50



CABEÇA DE BOLA

FG 138/M

~~60,00€~~

37,90€

JOGO 10 CHAVES MACHO TORX

Conteúdo: TX10 - TX50



Extremo magnético

FG 138/B

~~34,00€~~

17,90€

JOGO 10 CHAVES MACHO TORX - SERIE CORTA

Conteúdo: TX9 - TX50 - SERIE CURTA



FG 138/C

~~37,00€~~

19,90€

JOGO 10 CHAVES MACHO TORX - SERIE LONGA

Conteúdo: TX9 - TX50 - SERIE LONGA



FG 138

~~55,00€~~

29,90€

JOGO 12 CHAVES MACHO TORX

Conteúdo: TX7, 8, 9, 10, 15, 20, 25, 27, 30, 40, 45, 50



FG 88/25-S31

~~98,00€~~

59,00€

JOGO DE 30 PONTAS REFORÇADAS DE 1/4" E PORTA PONTAS MAGNÉTICO

Conteúdo: PH1, PH2, PH3 (x2);

PZ1, PZ2, PZ3;

SQ1, SQ2, SQ3;

T8, T9, T10, T15, T20, T25, T27, T30, T40;

H2, H3, H4, H5, H6, H8;

SL4, SL5.5, SL8

NEW



FG 85/S31

~~68,30€~~

39,90€

JOGO 31 PONTAS 1/4" + ADAPTADOR 1/4"X1/4"

Conteúdo: FG 88/60PI3; FG 85/25PH1, PH2, PH3;

FG 85/25SL3, SL4, SL4.5, SL5, SL6, SL6.5;

FG 85/25PZ1, PZ2, PZ3;

FG 85/H1.5, H2, H2.5, H3, H4, H5, H6;

FG 85/25T9, T10, T15, T20, T25, T27, T30, T40

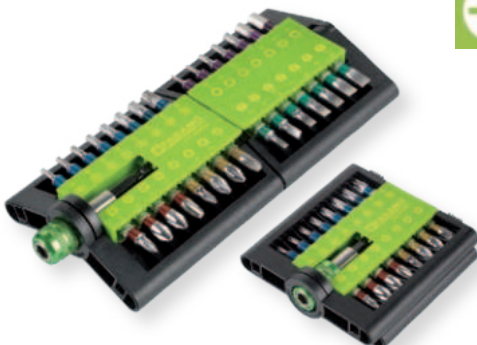

FG 85/175-S9

~~106,00€~~

65,00€

JOGO DE 8 CHAVES DE FENDAS BIVALENTES E 1 PUNHO

Conteúdo: FG 85/175FPH0, PH1, PH2 - G 85/175T6-8, T7-9, T10-15, T20-25, T30-40 - FG 85/IM



NEW



FG 85/175-S10

~~115,00€~~

69,00€

JOGO DE 9 CHAVES DE FENDAS BIVALENTES E 1 PUNHO

Conteúdo: FG 85/175FPH0, PH1, PH2 - FG 85/175PZ1-2 - FG 85/175H2.5 - H3,H4,H5,H6 - FG 85/IM



NEW



FG 59XT/S3

~~89,50€~~

49,90€

JOGO 3 ALICATES

Conteúdo: FG 59/XT180, FG 63/XT160, FG 61/XT160

FG 59XT/S3B

~~99,50€~~

59,90€

JOGO 3 ALICATES

Conteúdo: FG 63/H180, FG 61/XT200, FG 59/XT180



FG 58/C250

~~43,00€~~

26,90€

ALICATE AJUSTÁVEL COM CHARNEIRA SOBREPOSTA E LIBERTAÇÃO RÁPIDA

mm - polegares: 250 - 10"

HRC: 54-58

NEW



SISTEMA DESLIZANTE RÁPIDO SEM BOTÃO

FG 51/S4

~~105,00€~~

59,90€

JOGO 4 ALICATES DE FREIOS INTERIORES, COM PUNTAS REFORÇADAS DE AÇO 10-25MM

Conteúdo: FG 51/140, FG 52/140, FG 53/140, FG 54/140

FG 51/S4B

~~112,00€~~

62,90€

JOGO 4 ALICATES DE FREIOS INTERIORES, COM PUNTAS REFORÇADAS DE AÇO 19-60MM

Conteúdo: FG 51/180, FG 52/180, FG 53/180, FG 54/180



FG 55/S4

~~140,00€~~

79,90€

JOGO DE 4 ALICATES DE FREIOS INTERIORES, COM PUNTAS REFORÇADAS DE AÇO 10-25MM

Conteúdo: FG 55/140, FG 56/140, FG 57/140, FG 58/140

FG 55/S4B

~~145,00€~~

82,90€

JOGO DE 4 ALICATES DE FREIOS INTERIORES, COM PUNTAS REFORÇADAS DE AÇO 19-60MM

Conteúdo: FG 55/180, FG 56/180, FG 57/180, FG 58/180

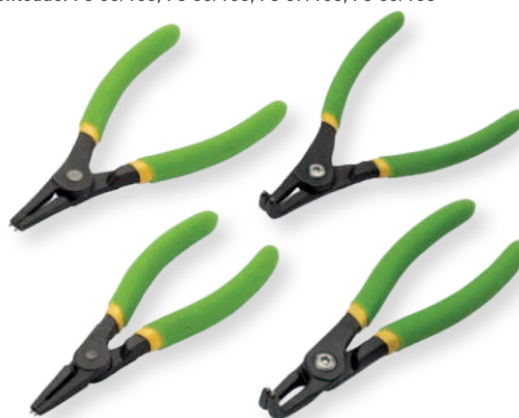

Insertos reforçados para excelentes anéis de vedação

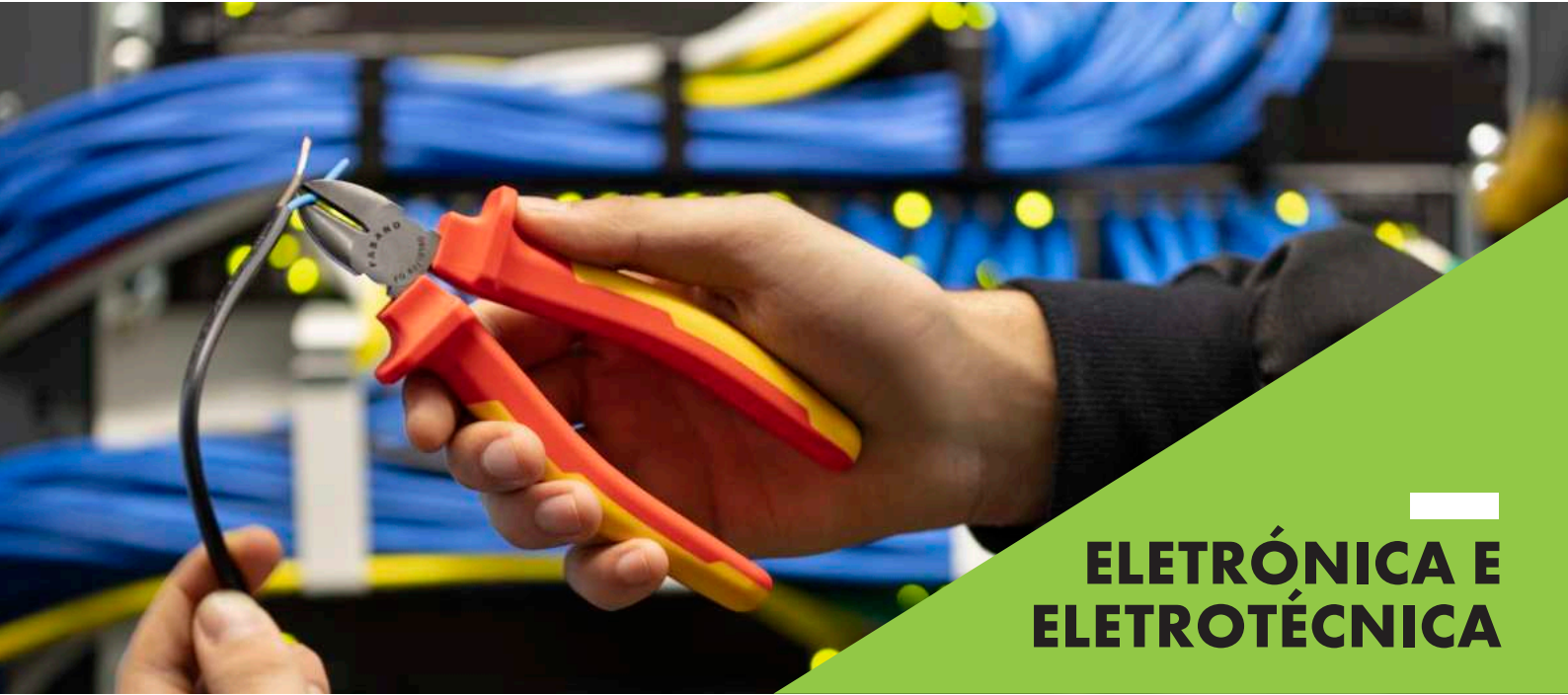

ELETRÓNICA E ELETROTÉCNICA

FG 22E/S6~~58,00€~~**34,90€****JOGO 6 CHAVES PARA PARAFUSOS**

Conteúdo: 3X100, 4X100, 5.5X125, PH0x60, PH1x80, PH2x100

**FG 22E/SZ6**~~58,00€~~**34,90€****JOGO 6 CHAVES PARA PARAFUSOS**

Conteúdo: 3X100, 4X100, 5.5X125, PZ0x60, PZ1x80, PZ2x100

**FG 59IS/S3**~~120,00€~~**64,90€****JOGO 3 ALICATEIS ISOLADAS**

Conteúdo: FG 59/IS180, FG 61/IS200, FG 63/IS160

**FG 536/1-IS**~~700,00€~~**439,00€****CHAVE DINAMOMÉTRICA ISOLADA DE 1/2" PARA DESLIGAR E BLOQUEAR**

Adequado para trabalhos com tensão inferior a 1000V AC (corrente alternada) e inferior a 1500V DC (corrente contínua)

Lado esquerdo

Em conformidade com a norma IEC 60900 de 1000V

Em conformidade com as normas DIN ISO 6789

**NEW****FG 68U/S439**~~298,00€~~**169,00€****JOGO DE ALICATE COM MATRIZ INTERCAMBIÁVEL**

+ 3 MATRIZ (FG 68/MAT4, FG 68/MAT16, FG 68/MAG), + 435 TERMINAIS ISOLADOS



FG 96/DG

195,00€

119,00€



MULTÍMETRO DIGITAL DC/AC - OHM

Classe II
 Categoria de sobretensão: CAT III 300V
 Teste de continuidade
 Freqüência: 10Hz-200kHz
 Teste de díodos
 Ciclo de trabalho 5%-95% RH ($\pm 0,1\%$)
 Temperatura - 20°C/400°C ($\pm 1,5\% \pm 3,0^\circ\text{C}$) / 400°C/1000°C ($\pm 2,0\% \pm 3,0^\circ\text{C}$)
 Medição de lux 4.000 lux (± 1) / 40.000 lux (± 10)
 Capacidade de detecção de humidade 30%-90% HR ($\pm 0,1\%$)
 Capacidade de detecção de som 35 - 100dB ($\pm 0,1\text{dB}$)
 Modo de espera após 15 minutos
 Indicador do nível da pilha
 Bateria de 9 V



DC	AC	Ω	DIMENSIONES MM
400mV-300V	4V-300V	400 Ω -40M Ω	165x80x35

FG 98/DG

340,00€

199,00€



MULTÍMETRO DIGITAL

Classe II
 Categoria de sobretensão: CAT IV 600V;
 CAT III 1000V
 Freqüência: 100 kHz
 Teste de díodos
 Fonte de alimentação: 1 x bateria de 9V



DC	AC	Ω	DIMENSIONES MM
200mV-1000V	2V-750V	200 Ω -20M Ω	184x90x46

FG 97/DG

135,00€

79,00€



MULTÍMETRO DIGITAL SMART

Classe II
 Categoria de sobretensão: CAT III 600V
 Teste de díodos
 Fonte de alimentação: 1 pilha AAA de 1,5V



DC	AC	Ω	DIMENSIONES MM
600mV-600V	6V-600V	600 Ω -60M Ω	148x76x21

FG 99/DG

250,00€

149,00€



PIÇA DE CORRENTE

Classe II
 Categoria de sobretensão: CAT III 600V
 Temperatura: -20°C a 1000°C (-4°F a 1832°F)
 Freqüência: 10Hz; 100Hz; 1000Hz; 10kHz; 100kHz; 1000kHz; 10MHz
 Teste de díodos
 Fonte de alimentação: 3 pilhas de 1,5V TIPO AAA



DC	AC	Ω	DIMENSIONES MM
600mV-600V	6V-600V	600 Ω -60M Ω	194x59x29



CHAVES DINAMOMÉTRICAS

PONTA PARA PARAFUSOS DE PERFIL TORX

Precisão $\pm 4\%$

Fornecido com certificado de calibração



CÓDIGO	RISOLUZIONE NM	ATTACCO	NM	€/LISTINO	€/PROMO
FG 531	0.1	1/4"	5-25	215,00€	132,00€
FG 533/2	0.25	3/8"	10-50	240,00€	142,00€
FG 536/1	0.5	1/2"	20-100	240,00€	145,00€
FG 536/2	1.0	1/2"	40-200	250,00€	149,00€
FG 536/3	2.0	1/2"	60-340	285,00€	169,00€
FG 540/1	2.5	3/4"	150-750	1.050,00€	629,00€
FG 540/2	2.5	3/4"	200-1000	1.200,00€	719,00€



BARRA DINAMOMÉTRICAS PARA APERTO DIREITO E ESQUERDO - 3/4"

Precisão $\pm 4\%$.

Fornecido com certificado de calibração

Fornecido em caixa ABS

CÓDIGO	NM	ATTACCO QUADRO	€/LISTINO	€/PROMO
FG 538/1	140-560	3/4"	800,00€	499,00€
FG 538/2	200-800	3/4"	880,00€	559,00€
FG 539/1	200-1000	1"	1.150,00€	699,00€



CHAVES DINAMOMÉTRICAS DIGITAL DE ROQUETE REVERSÍVEL EM NM E GRAUS - 1/2"



Precisão: ± 4%
 Mão Direita e Esquerda
 Duplo modo de medição: PEAK e TRACK
 Som de 12 LED e indicador visual a realização do torque predeterminado
 Possibilidade de memorizar até 250 rascunhos diferentes graças ao software para PC incluído no kit
 Interface de PC via USB
 Capacidade de configurar até 9 rascunhos pré-definidos
 Fonte de alimentação: 2 baterias de 1,5V (incluídas)

CÓDIGO	NM	€/LISTINO	€/PROMO
FG 543/DG1	6.8-135	675,00€	399,00€
FG 543/DG2	10-200	790,00€	469,00€



FG 546/DG ~~330,00€~~ **199,00€**

CHAVES DE APERTO ANGULAR DIGITAL EM NM E GRAUS



Precisão: ± 2%
 Mão Direita e Esquerda
 Duplo modo de medição: PEAK e TRACK
 Som de 6 LED e indicador visual a realização do torque predeterminado
 Possibilidade de memorizar até 50 rascunhos diferentes
 Fonte de alimentação: 2 baterias de 1,5V (incluídas)



FG 547/DG ~~210,00€~~ **125,00€**

CHAVES DE APERTO ANGULAR DIGITAL EM NM

Precisão: ± 2%
 Mão Direita e Esquerda
 Som de 6 LED e indicador visual a realização do torque predeterminado
 Equipado com um suporte magnético



CHAVE DE FENDAS DE BINÁRIO LIVREMENTE AJUSTÁVEL



Precisão de aperto ±6%.

CÓDIGO	NM	L/MM	€/LISTINO	€/PROMO
FG 559/1	0.1-1.2	155	220,00€	129,00€
FG 559/2	1-6	155	230,00€	139,00€



CHAVE DE FENDAS DE BINÁRIO LIVREMENTE AJUSTÁVEL

CÓDIGO	NM	RAPPORTO	€/LISTINO	€/PROMO
FG 581/A	231-1.500	1:6.5	850,00€	499,00€
FG 581/B	208-2.500	1:12	1.320,00€	799,00€



FERRAMENTAS DE CORTE

FG 70/S110

~~350,00€~~

199,00€

JOGO DE 110 MACHOS E CAÇONETOS EM AÇO AO CRÓMIO E ACESSÓRIOS

Roscas métricas de passo grosso e fino



						ACCESÓRIOS
2x.04	6x0.75	12x1	2x0.4	6x0.75	12x1	GF25x9
3x0.5	7x0.75	12x1.25	3x0.5	7x0.75	12x1.25	GF8x14
4x0.7	8x0.75	12x1.5	4x0.7	8x0.75	12x1.5	GMM1.5
5x0.8	8x1	14x1	5x0.8	8x1	14x1	GMM3
6x1	9x0.75	14x1.25	6x1	9x0.75	14x1.25	GMC1
7x1	9x1	14x1.5	7x1	9x1	14x1.5	
8x1.25	10x0.75	16x1	8x1.25	10x0.75	16x1	
9x1.25	10x1	16x1.5	9x1.25	10x1	16x1.5	
10x1.5	10x1.25	18x1.5	10x1.5	10x1.25	18x1.5	
11x1.5	11x0.75		11x1.5	11x0.75		
12x1.75	11x1		12x1.75	11x1		
14x2	11x1.25		14x2	11x1.25		
16x2	12x0.75		16x2	12x0.75		

FG 75TIN/S25

~~240,00€~~

139,00€

JOGO BROCAS RECTIFICADAS EM HSS-TIN 5%

Conteúdo: 1-13x0,5mm



FG 75CO/S25

~~248,00€~~

149,00€

JOGO BROCAS RECTIFICADAS EM HSS-COBALT 5%

Conteúdo: 1-13x0,5mm



FG 49/L

~~19,00€~~

11,90€

TESOURA COM LÂMINA EM AÇO INOXIDÁVEL

L/mm 200
Abertura máxima 151 mm
HRC: 52-54



FG 77/TT

~~9,90€~~

5,90€

CORTA TUBOS COM LÂMINA EM AÇO INOXIDÁVEL

L/mm: 226
Capacidade: 3-36mm
HRC: 48-52
Para tubos de borracha



FG 49/MU

~~28,00€~~

17,90€

TESOURA COM LÂMINAS DIREITAS EM AÇO INOXIDÁVEL, COM MICRO-DIENTES

HRC: 52-54



TESOURA MODELO AMERICANO COM LÂMINAS LARGAS E DIREITAS

HRC: 58-61



CÓDIGO	L/MM	ACCIAIO	INOX	€/LISTA	€/PROMO
FG 49/HE200	200	0.53mm	0.36mm	22,00€	13,90€
FG 49/HE250	250	0.78mm	0.46mm	27,00€	16,90€
FG 49/HE300	300	0.94mm	0.78mm	35,00€	21,90€
FG 49/HE350	350	1.24mm	0.78mm	40,00€	24,90€

FG 49/TC

~~44,00€~~

27,90€

TESOURA PARA ELECTRICISTA, COM ENTALHE PARA DESCARNAR CABO Y CORPO INTEIRAMENTE EM AÇO

L/mm 140 - H/mm 65
Lâmina de aço micro serrilhada
HRC: 56
Construção integral em aço inoxidável
Cortador de cabos 12mm
Com suporte para cinto



Suporte de cinto ABS



Construção totalmente em aço forjado

FG 49/TCX

~~62,00€~~

34,90€

TESOURA PARA ELECTRICISTA, COM ENTALHE PARA DESCARNAR CABO Y CORPO INTEIRAMENTE EM AÇO

L/mm 160 - A/mm 50
Lâmina de aço micro-serrilhada
HRC: 56
Estrutura integral de aço inoxidável
Cortador de cabo de 15 mm
Com suporte de correia



Construção totalmente em aço forjado



Suporte de cinto ABS

FG 49/CF

~~32,00€~~

17,90€

TESOURA PARA ELECTRICISTA COM FERRAMENTA DE ENGASTE PARA TERMINAIS DE TUBOS

L/mm 155 - A/mm 45
Com entalhe para descarnar cabo e ferramenta de engaste para terminais de tubos
Lâmina de aço - HRC 52-54
Capacidade do cortador de cabos 12mm



NEW



FG 77/PVC4

~~50,00€~~

31,90€

TESOURA COM ROQUETE

Sistema de cremalheira com avanço progressivo
Equipada com plataforma de nylon para facilitar o corte de perfis planos
Para tubos de PVC
Ømm: 0-42





MANUTENÇÃO GERAL

FITAS MÉTRICAS, REVESTIMENTO ABS DE 2 COMPONENTES RESISTENTE AO CHOQUE, FITA EM AÇO

Classe II



CÓDIGO	L/MT	BANDA MM	€/LISTA	€/PROMO
FG 44/MT3	3	16	11,50€	6,90€
FG 44/MT5	5	25	19,00€	11,90€
FG 44/MT8	8	25	24,00€	13,90€
FG 44/MT10	10	25	29,00€	16,90€

FG 95/CA

~~52,00€~~

29,90€

PAQUÍMETRO LEITURA CINQUAGESIMAL

Escada cromada
Haste fina
Fecho de parafuso
Aço inoxidável endurecido
L/mm: 150

FG 95/CA2

~~125,00€~~

74,90€

PAQUÍMETRO EM AÇO INOXIDÁVEL LEITURA CINQUAGESIMAL

Escada cromada
Haste fina
Fecho de parafuso
Aço inoxidável endurecido
L/mm: 200



FG 95/DG

~~96,00€~~

56,90€

PAQUÍMETRO DIGITAL LEITURA CENTESIMAL

L/mm: 150



FG 96/CA

~~55,00€~~

32,90€

PAQUÍMETRO LEITURA VIGESIMAL

L/mm: 150

NEW

FG 96/CA2

~~130,00€~~

69,00€

PAQUÍMETRO LEITURA VIGESIMAL

L/mm: 200

NEW



FG 127/S1

~~49,50€~~

29,90€

JOGO 6 FERRAMENTAS DE PERCUSSÃO



FG 128C/S6

~~46,50€~~

27,90€

JOGO DE 6 SACA-TROÇOS

Medições: 2, 3, 4, 5, 6, 8mm



FG 712/L4

~~120,00€~~

49,00€

RECIPIENTE DE PEÇAS PEQUENAS COM COMPARTIMENTOS GIRATÓRIOS

Fornecido com divisórias interiores
Equipado com 4 prateleiras giratórias e tabuleiro superior para utensílios
Material: ABS resistente ao impacto
Equipado com 4 pés de apoio



FG 712/A

~~50,00€~~

19,90€

PORTA-FERRAMENTAS/PEÇAS PEQUENAS EQUIPADO COM RODAS GIRATÓRIAS

2 compartimentos magnéticos para peças pequenas
2 compartimentos grandes para ferramentas
Equipado com placa central magnética
3 rodízios giratórios de 50 mm
Material: ABS resistente a impactos



FG 92/PM

~~19,50€~~

11,90€

EXTENSÃO MAGNÉTICA FLEXÍVEL

Haste de 1 metro
Pega de borracha antiderrapante



FG 92/GR

~~27,00€~~

15,90€

EXTENSÃO MAGNÉTICA FLEXÍVEL

Capacidade 1 kg
L/mm 700
Equipado com mandíbulas de preensão



Com garras preñseis

FG 92/PM4

~~27,50€~~

13,90€

EXTENSÃO MAGNÉTICA TELESCÓPICA

L/mm 165-622
Pega em PVC antiderrapante
Capacità 2,3 kg



FG 92/PF

~~27,50€~~

14,90€

EXTENSÃO MAGNÉTICA ARTICULADA

Capacidade 3,5 kg
L/mm haste 400
Ø/mm 1,5
Ponta magnética





FG 98/GAS

130,00€

79,00€

SOLDADOR A GÁS PORTÁTIL

Temperatura máxima: 210-450 °C
25 watts
Autonomia 120 minutos
Fornecido com pontas para soldar, cortar e soprar
Fornecido em caixa ABS



FG 98/LT

186,00€

119,00€

FERRO DE SOLDAR RECARREGÁVEL COM BATERIAS DE LÍTIO

Temperatura máxima: 600 °C
Autonomia 40 minutos
Tempo de carregamento 3,5h
Fornecido com pontas para soldar, cortar e soprar
Fornecido em caixa ABS



FG 96/SS36

65,00€

39,90€

SOLDADOR DE PALHETAS DE DUPLA POTÊNCIA

Classe de proteção I
30/60 Watt - 230V - Ø/mm 5.8



FG 494/S12

55,00€

33,90€

PISTOLA DE COLA QUENTE

Potência de aquecimento nominal 80W
Temperatura de funcionamento: 193°C (383 °F)
Tempo de aquecimento: 3/5 minutos
Comprimento do bastão de cola: 200mm
Diâmetro do bastão de cola: 11,5 mm
Fornecido em caixa ABS com 12 bastões de cola incluídos



FG 96/SS30

48,00€

29,90€

SOLDADOR

Classe de proteção I
30 Watt - 230V - Ø/mm 4 - 430 °C



FG 494/A180

175,00€

109,00€

PISTOLA DE COLA QUENTE

Potência nominal de aquecimento 180W
Temperatura de funcionamento 193°C
Tempo de aquecimento 3/5 minutos
L/mm stick cola 100/250/350
Stick cola Ø/mm 11/11,5
Equipado com um pé de apoio para evitar que a ponta aquecida toque na superfície da bancada
Fornecido com 1 bocal de substituição



FG 96/SS60

60,00€

36,00€

SOLDADOR

Classe de proteção I
60 Watt - 230V - Ø/mm 6 - 500 °C



TORNO DE BANCADA PARALELO EM AÇO FORJADO

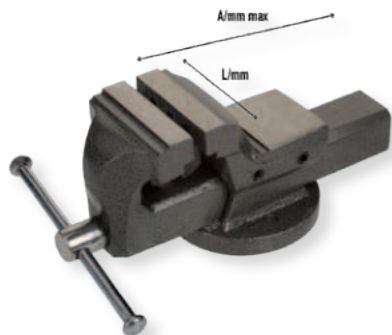

CÓDIGO	L/MM	A/MM	€/LISTA	€/PROMO
FG 121/B125	125	150	300,00€	179,00€
FG 121/B150	150	200	380,00€	229,00€
FG 121/B200	200	220	560,00€	339,00€

FG 125/S3

~~68,00€~~

41,90€

JOGO DE 3 ALAVANCAS

Conteúdo: 300, 450, 600 mm



FG 93/M50

~~30,00€~~

17,90€

ESPELHO DE AÇO TELESCÓPICO E ARTICULADO

Ø/mm espelho 50

L/mm haste 240-698



FG 93/M95

~~30,00€~~

17,90€

ESPELHO DE AÇO TELESCÓPICO E ARTICULADO

Dimensões do espelho mm 50x95

L/mm haste 370-775



FG 493/AL

~~46,00€~~

28,90€

PISTOLA DE SELAGEM COM TUBO DE ALUMÍNIO

L/mm 240

Equipado com sistema anti-gotejamento

Capacidade 300cc



FG 493/N

~~39,00€~~

23,90€

PISTOLA DE SELAGEM COM TUBO DE AÇO

Corpo principal e mecanismo interno totalmente em aço

Capacidade 300cc



MARTELOS PARA MECÂNICO COM CABO DE RESINA



CÓDIGO	GR	L/MM	€/LISTA	€/PROMO
FG 132/200	200	294	19,00€	11,90€
FG 132/300	300	297	20,50€	12,90€
FG 132/500	500	312	22,00€	13,90€
FG 132/800	800	342	28,00€	17,90€
FG 132/1000	1.000	343	30,00€	18,90€

MAÇO COM PUNHO EM MADEIRA E COLAR DE PROTEÇÃO CABO



CÓDIGO	GR	L/MM	€/LISTA	€/PROMO
FG 134/H800	800	260	22,00€	13,90€
FG 134/H1000	1.000	262	23,50€	14,90€
FG 134/H1250	1.250	262	25,50€	15,90€
FG 134/H1500	1.500	280	30,00€	18,90€
FG 134/H2000	2.000	300	36,00€	22,90€



FG 1450

~~132,00€~~

83,90€

BOLSA DE FERRAMENTAS DE TECIDO TECNICO 600D

Tecido técnico de alta resistência
 Base semi-rígida com rebordos de plástico
 Grande compartimento central
 Vários bolsos interiores e exteriores
 Bolso traseiro fechado e bolso frontal duplo fechado com presilhas
 Alça de ombro almofadada ajustável



BOLSO FECHADO NAS COSTAS

BASE SEMI-RÍGIDA

VÁRIOS BOLSOS INTERNOS



FG 1452

~~140,00€~~

89,00€

CESTA DE FERRAMENTAS DE TECIDO TECNICO 600D COM TAMPA

Estrutura rígida em tecido técnico de alta resistência
 Base de plástico rígido para proteção do conteúdo
 Grande compartimento aberto para um acesso fácil ao conteúdo
 Tampa com fecho de velcro
 Pega metálica com punho de borracha macia
 Vários bolsos e presilhas interiores e exteriores
 Bolso lateral fechado e bolso frontal para serra
 Alça de ombro almofadada ajustável



GRANDE COMPARTIMENTO CENTRAL VÁRIOS BOLSOS ABERTO

TAMPA DE FECHO COM VELCRO OCULTO



FG 1454

~~186,00€~~

119,00€

BOLSA DE FERRAMENTAS DE TECIDO TECNICO 600D

Estrutura rígida em tecido técnico de alta resistência
 Base de plástico rígido para proteção do conteúdo
 Dois grandes compartimentos separados
 Vários bolsos e presilhas interiores e exteriores
 Bolsos fechados nas costas e na frente
 Pega confortável e alça de ombro almofadada ajustável



BOLSO FECHADO NAS COSTAS

VÁRIOS BOLSOS INTERNOS



FG 1456

235,00€

149,00€

CARRINHO DE FERRAMENTAS PARA TECIDO TECNICO 600D

Tecido técnico de alta resistência
Pega telescópica e 2 rodas robustas para um transporte fácil
Construção rígida com grande compartimento interior para guardar ferramentas eléctricas, ferramentas manuais e acessórios
Bolsos interiores e exteriores para uma organização óptima do espaço
2 bolsos exteriores fechados à frente



TECIDO TÉCNICO DE ALTA RESISTÊNCIA

GRANDE COMPARTIMENTO INTERNO

2 RODAS PARA TRANSPORTE



FG 1460

150,00€

89,00€

MOCHILA DE FERRAMENTAS EM TECIDO TECNICO 600D

Tecido técnico de alta resistência
Base de plástico rígido para proteção do conteúdo
Compartimento interno duplo, compartimento para ferramentas e compartimento para computador portátil e documentos
Vários bolsos laterais e frontais, interiores e exteriores
Encosto ergonómico almofadado
Alças acolchoadas para os ombros e alça ajustável para o peito



ALÇAS ACOLCHOADAS

COMPARTIMENTO INTERNO DUPLO COM SUPORTE PARA PC

BASE DE PLÁSTICO RÍGIDO



FG 1465

200,00€

119,00€

MOCHILA DE FERRAMENTAS DE TECIDO TECNICO 600D COM RODAS E SISTEMA TROLLEY

Dimensões da bagagem de mão
Tecido técnico de alta resistência
Pega telescópica retrátil
Rodas integradas com tampa rebatível
Compartimento interior duplo, compartimento para ferramentas e compartimento para computador portátil e documentos
Vários bolsos laterais e frontais, interiores e exteriores
Encosto ergonómico almofadado
Alças de ombro almofadadas e alça peitoral ajustável e bloqueável



DIMENSÕES DA BAGAGEM DE MÃO

COMPARTIMENTO INTERNO DUPLO

CAPA DE RODA DOBRÁVEL





FG 113/A

198,00€

119,00€

CAIXA DE FERRAMENTAS DE CHAPA METÁLICA

Equipado com pegas laterais rebatíveis
Predisposição para cadeado
Estrutura em chapa de aço 0,8 mm
Dimensões 520x290x290 mm



FG 113/B

220,00€

129,00€

CAIXA DE FERRAMENTAS DE CHAPA METÁLICA

Equipado com pegas laterais rebatíveis
Predisposição para cadeado
Estrutura em chapa de aço 0,8 mm
Dimensões 650x350x350 mm



FG 113/C

260,00€

149,00€

CAIXA DE FERRAMENTAS DE CHAPA METÁLICA

Equipado com pegas laterais rebatíveis
Predisposição para cadeado
Estrutura em chapa de aço 0,8 mm
Dimensões 850x350x350 mm



FG 113/D

320,00€

189,00€

CAIXA DE FERRAMENTAS DE CHAPA METÁLICA

Equipado com pegas laterais rebatíveis
Predisposição para cadeado
Estrutura em chapa de aço 0,8 mm
Dimensões 1000x400x450 mm



FG 111/AS104

863,50€

329,00€

CAIXA EXTENSÍVEL COM 5 DIVISÕES E SORTIDO DE 104 FERRAMENTAS



FG 111/A

62,00€

32,90€

CAIXA EXTENSÍVEL COM 3 DIVISÕES EM CHAPA METÁLICA

Previsão para cadeado
Divisória do compartimento superior
Estrutura em chapa metálica
Dimensões 430x200x160 mm



CAIXA EXTENSÍVEL COM 5 DIVISÕES EM CHAPA METÁLICA

Previsão para cadeado
Divisória do compartimento superior
Estrutura em chapa metálica



CÓDIGO	DIMENSIONI MM	€/LISTA	€/PROMO
FG 111/B	430x200x200	75,00€	39,90€
FG 111/C	530x200x200	94,00€	49,90€

UMA AMPLA GAMA DE SOLUÇÕES PARA ILUMINAR O SEU TRABALHO!

Uma proposta completa, com inúmeros modelos funcionais e de alto desempenho, ideais para iluminar a área de trabalho durante as operações de inspeção, manutenção e reparação.

COMPACTE

FG 203 - FG 204 - FG 213/L480

SUBTIL

FG 211 - FG 212 - FG 207 - FG 207/B - FG 206

TOCHAS

FG 214/L600 - FG 201

SEM FIO

FG 210/W - FG 213/DP - FG 213/W - FG 213/S3

LUZES DE TRABALHO

FG 221 - FG 224/L5200 - FG 222/B - FG 217/B - FG 210/C

CONTROLAR COR

FG 234 - FG 235 - FG 236

SOB O CAPÔ

FG 209 - FG 210/B

MULTIFUNÇÕES

FG 202 - FG 222/A - FG 205/B



ILUMINAÇÃO

FG 203

~~22,80€~~

12,90€

MAX 100 LUMEN

0.5h

MAX 3h

MINI PROJETOR PORTÁTIL LED

Equipado com ímanes traseiros, função de gestão da intensidade, porta de carregamento dupla. Cabo de carregamento USB incluído. Corpo em alumínio anodizado. Função de regulação da intensidade. Dimensões 28,4x32 mm



PORTAS DE CARREGAMENTO DUPLAS TIPO C E MICRO USB



BASE MAGNÉTICA



CE

FG 204

~~32,50€~~

19,90€

MAX 300 LUMEN

LI-10N BATTERY

2.5h

MAX 3h

MINI LÂMPADA LED PORTÁTIL

Bateria de lítio de longa duração. Dimensões 21x89 mm



EQUIPADO COM BASE MAGNÉTICA



CE

FG 213/L480

~~65,00€~~

39,90€

MAX 480 LUMEN

2.5h

MAX 10h

LÂMPADA DUPLA LED COM SENSOR ON/OFF SEM CONTATO

Com sensor on/off sem contacto. 4 níveis de inclinação. Indicador do estado de carga. 4 ímanes traseiros para utilização sem banda elástica. Cabo USB tipo C incluído. Dimensões 67x34



EQUIPADO COM 4 ÍMANES TRASEIROS PARA UTILIZAÇÃO SEM ELÁSTICO



4 NÍVEIS DE INCLINAÇÃO



SENSOR DE LIGAR/DESLIGAR SEM TOQUE



CE

FG 211

110,00€

59,90€

LÂMPADA LED RECARREGÁVEL

MAX 600 LUMEN

CE



385mm



LED superior apontando



Rotação de 360



Base magnética gancho removível

FG 207

65,00€

37,90€

LÂMPADA LED RECARREGÁVEL

Led de ponta superior
180° pivotante
Base magnética
Indicador do estado de carga
Classificação IP54 de resistência à água e ao pó
Cabo USB tipo C incluído
H/mm 300

MAX 300 LUMEN

CE



300mm



FG 212

78,00€

42,90€

LÂMPADA LED RECARREGÁVEL

MAX 200 LUMEN



174mm



Rotação de 360

FG 207/B

98,00€

59,90€

LÂMPADA LED RECARREGÁVEL

Led de topo
Pivotante e rotativo a 180
3 níveis de indicação de autonomia restante
Base magnética
Gancho amovível integrado na base
Grau de resistência à água e ao pó IP54
Grau de resistência ao impacto IK07
Cabo USB tipo C incluído
Dimensões 66x400 mm

MAX 700 LUMEN



400mm



Giratório até 180°



Seletor de brilho 60-700 lúmens



Giratório até 180°



FG 206

~~56,00€~~

33,90€

LÂMPADA LED RECARREGÁVEL

Design fino
Ímanes na parte de trás
Gancho para pendurar a lâmpada
Grau de proteção IPX4
Cabo micro USB incluído
Dimensões 10x249



MAX 360 LUMEN

CE



Gancho superior



Extra plano

FG 201

~~50,00€~~

29,90€

LANTERNA MAGNÉTICA RECARREGÁVEL PARA TELESCÓPIO

Luminosidade 100/30 lúmenes
Autonomia
- 2h (modo de alta intensidade)
- 6h (modo de baixa intensidade)
Tempo de recarga 2,5h
LED indicador do estado de carga no botão ON/OFF
Gancho lateral
Vara telescópica extensível até 505 mm
Cabo USB tipo C incluído
Dimensões 21x18x178mm



MAX 100 LUMEN

NEW

CE



Gancho de cinto



Função pick-up
-capacidade de ímanes de 1,2 kg



Varilla telescópica (máx. 505 mm)

FG 214/L600

~~85,00€~~

39,90€

TOCHA LED RECARREGÁVEL

Cone de luz ajustável
Indicador do estado de carregamento
Base de carregamento incluída
com montagem na parede e cabo USB



MAX 600 LUMEN

CE



Cone de luz ajustável



Placa de suporte de parede fornecida

FG 202

~~56,00€~~

33,90€

LÂMPADA RECARREGÁVEL DE LED COM SISTEMA TSC

LED apontador superior
TSC SYSTEM, tecnologia de desligamento automático em contacto com superfícies
Corpo em alumínio anodizado
Íman duplo, na base e no verso
Gancho para cinto
Cabo USB tipo C incluído
Dimensões 46x115 mm



MAX 1200 LUMEN

CE



Gancho de cinto traseiro



LED a apontar para cima



**TECNOLOGIA
DESLIGAR
POR CONTACTO**



FG 222/A

120,00€

49,00€

LÂMPADA DE LED RECARREGÁVEL COM ALTO-FALANTES SEM FIO

Led apontador superior
Altifalante duplo sem fios de 5 W
Gancho com ímanes integrados, amovível e giratório a 180 para pendurar ou apoiar o candeeiro
Classificação IP54 de resistência à água e ao pó
Cabo USB tipo C incluído
Dimensões 65x164 mm



MAX 500 LUMEN



Caso duplo 5W sem fios



Ponteiro LED com mais de 160 lúmens



FG 217/B

300,00€

169,00€

LÂMPADA RECARREGÁVEL COM 3 LUZES LED

Brilho 6000/3000/1500 lúmens
Também pode ser utilizada ligada ao carregador com 500 lm de luminosidade
Potente bateria de lítio de 7,3V - 8000mAh
Autonomia:
- 9h (modo de baixa intensidade)
- 5h (modo de intensidade média)
- 3h (modo de alta intensidade)
Tempo de recarga: 10h
3 luzes LED giratórias (180°) e rotativas (270°)
4 LEDs que indicam o estado de carregamento
Função Power Bank 5V 1A
Base magnética com gancho amovível integrado
Altura total de 1700 mm (incluindo a lâmpada)
Saco de nylon incluído
Cabo USB tipo C incluído
Dimensões 90x90x205



3 ímanes en la base



As lâmpadas rotativas têm um ângulo de 270°

NEW



MAX 6000 LUMEN

FG 205/B

85,00€

49,90€

LÂMPADA LED PORTÁTIL

LED frontal com 600/200 lúmenes de luminosidade
LED de mira superior com 200 lúmenes de luminosidade
Autonomia do LED frontal
- 3h (modo de alta intensidade)
- 12h (modo de baixa intensidade)
Autonomia do LED superior: 9h
Tempo de recarga: 3h
Gancho giratório amovível na parte de trás
Base giratória de 180° com íman integrado
4 LEDs que indicam o estado de carregamento
Cabo USB tipo C incluído
Dimensões 54x32x186



NEW



Um gancho amovível de 360°.



Base giratória de 180° com íman integrado.

MAX 600 LUMEN



TRIPÉ TELESCÓPICO ATÉ 1,70 M



FG 210/C

165,00€

99,00€

REFLETOR DE TRABALHO DE LED RECARREGÁVEL

Função de banco de potência (saída USB máxima 5V 2A)
 Suporte giratório de 180°
 5 níveis de indicação da autonomia restante
 Classificação IP65 de resistência à água e ao pó
 Grau de resistência ao impacto IK07
 Índice de restituição de cor CRI 70+
 Cabo USB tipo C incluído
 Dimensões 208x140 mm



CLASSIFICAÇÃO DE PROTEÇÃO IP65

MAX 3000 LUMEN



SUPOORTE AJUSTÁVEL DE 180°



FUNÇÃO DE BANCO DE POTÊNCIA

CE

FG 221

340,00€

159,00€

LUZ DE TRABALHO DE FEIXE DUPLA

Rotação horizontal de 180° por luminária: ilumina eficazmente diferentes áreas do ambiente de trabalho
 Corpo giratório de 90°
 Bateria de lítio amovível de 14,8 V com função Power Bank (saída USB máx. 5 V 2 A)
 5 níveis de indicação da vida útil restante da bateria
 Carregador de bateria incluído
 Dimensões 190x295 mm



BATERIA DE LÍTIO COM FUNÇÃO DE POWER BANK

MAX 4500 LUMEN



BATERIA REMOVÍVEL



ELEMENTOS DE ILUMINAÇÃO AJUSTÁVEIS ATÉ 180°

CE

FG 224/L5200

250,00€

129,00€

LUZ DE CONSTRUÇÃO DE LED RECARREGÁVEL COM LENTE ANTIRREFLEXO

Lente opaca especial que reduz o encandeamento e aumenta a difusão da luz
 Suporte giratório de 180° que pode ser ligado a um tripé
 3 níveis de indicação da vida útil restante da bateria
 Classificação IP65 de resistência à água e ao pó
 Grau de resistência ao impacto IK07
 Carregador de bateria incluído
 Dimensões 273x205 mm



CLASSIFICAÇÃO DE PROTEÇÃO IP65

MAX 5200 LUMEN



AJUSTÁVEL ATÉ 180°



CE

FG 224/SU

100,00€

49,00€

TRIPÉ DE LUZ DE CONSTRUÇÃO FG 224/L5200

Altura máxima 1,60 M



FG 222/B

~~350,00€~~

169,00€

MAX 4000 LUMEN

LUZ DE TRABALHO DE LED RECARREGÁVEL COM ALTO-FALANTES SEM FIO

Altifalante duplo sem fios de 10 W
 Função de banco de potência (saída USB máxima 5V 1A)
 Corpo giratório de 140
 5 níveis de indicação da duração restante da bateria
 Gancho removível e giratório integrado na base
 Classificação IP65 de resistência à água e ao pó
 Carregador de bateria incluído
 Dimensões 210x210 mm



GANCHO INTEGRADO AMOVÍVEL E GIRATÓRIO



ALTIFALANTES SEM FIOS DE 10 W



CORPO GIRATÓRIO DE 140



FG 209

~~265,00€~~

149,00€

MAX 1200 LUMEN



LÂMPADA RECARREGÁVEL LED COM LENTE TRANSPARENTE E SEMITRANSARENTE



MODO BRILHANTE (1200 LM)



MODO CONFORTÁVEL (1100 LM)



MODO SUAVE (600 LM)



FG 210/B

~~85,00€~~

49,90€

MAX 1200 LUMEN



LANTERNA LED DE TUBO PORTÁTIL

Equipado com um projetor de luz superior
 Base magnética
 Modo de luz vermelha de emergência
 Inclui cabo de carregamento USB tipo C
 Função de regulação da intensidade da luz



HOLOFOTE DE 400 LÚMENS



CARREGADOR USB TIPO C



SISTEMA DE FIXAÇÃO MAGNÉTICA



SEM FIO



SISTEMA DE CARREGAMENTO INTELIGENTE

FG 210/W

~~75,00€~~

44,90€

MAX 670 LUMEN

NEW

PROJETOR LED PORTÁTIL

Luminosidade 670/350/120 lúmenes

Luz pontual 250 lúmenes

Autonomia

- 2,5h (modo de alta intensidade)

- 4,5h (modo de intensidade média)

- 10h (modo de baixa intensidade)

Autonomia do projetor LED: 4,5h

Recarregável em dois modos

- na base de carregamento sem fios (FG 213/DP não incluída) em 6h

- com o cabo USB tipo C fornecido em 4h

3 LEDs que indicam o estado de carregamento

Projetor ajustável a 210° com ímã integrado

Dimensões: 83x35x100 mm



FOCO DE LUZ/FOCO DE LUZ DIFUSO



LÂMPADA ORIENTÁVEL 210°

FG 213/DP

~~90,00€~~

56,90€

NEW

BASE DE CARREGAMENTO WIRELESS

Duas posições de carregamento simultâneo com acoplamento magnético para lâmpadas FG 210/W, FG 213/W e uma posição de 170 mm para smartphone.

Input: Máximo 10Wx2

Dimensões: 290x27x102 mm



3 ÍMANS FORTES NA PARTE TRASEIRA



SUPORTE AMOVÍVEL PARA SMARTPHONE COM CARREGAMENTO SEM FIOS

FG 213/W

~~99,00€~~

62,90€

NEW

LÂMPADA LED RECARREGÁVEL

LED frontal com 1000/500/250 lúmenes de luminosidade

LED de mira superior com 200 lúmenes de luminosidade

Autonomia do LED frontal

- 1,5h (modo de alta intensidade)

- 2,5h (modo de intensidade média)

- 5h (modo de baixa intensidade)

Autonomia do LED superior: 7h

Recarregável em dois modos

- na base de carregamento sem fios (FG 213/DP não incluída) em 6,5h

- com o cabo USB tipo C incluído em 4,5h

Revestimento antiderrapante em borracha

3 LEDs que indicam o estado de carregamento

2 ganchos giratórios amovíveis na parte de trás

3 ímanes na parte de trás + 1 na base

Lâmpada ajustável a 180°

Grau de proteção IP65

Dimensões: 53x38x260 mm



2 GANCHOS AMOVÍVEIS
ROTAÇÃO DE 360°



BASE MAGNÉTICA ROTATIVA DE 180°



3 ÍMANES NA PARTE DE TRÁS



MAX 1000 LUMEN

FG 213/S3

~~264,00€~~

165,90€

NEW

BASE DE CARREGAMENTO WIRELESS

Base de carregamento wireless com lâmpada e projetor



**SUPORTE REMOVÍVEL
PARA SMARTPHONE
COM RECARGA
SEM FIO**





LÂMPADAS PARA CONTROLAR COR

SETOR DE CARROÇARIAS



FG 234

105,00€

59,00€



FAROL DE LED COM ALTO ÍNDICE DE REPRODUÇÃO DE CORES PARA CONTROLE DE CORES

Índice de restituição de cor elevado CRI 96+
3 opções de temperatura de cor 2700K/4500K/6500K
Cabo USB incluído
Dimensões 50x50 mm

COB LED - cri 96+
3 COLORI
2700K 4500K 6500K



SENSOR ON/OFF SEM CONTACTO

4 NÍVEIS DE INCLINAÇÃO

FG 235

135,00€

79,00€

LÂMPADA RECARREGÁVEL DE LED COM ALTO ÍNDICE DE REPRODUÇÃO DE CORES PARA CONTROLE DE CORES

Elevado índice de restituição de cor CRI 96+
3 opções de temperatura de cor 2700K/4500K/6500K
Classificação IP65 de resistência à água e ao pó
Grau de resistência ao impacto IK07
Base de carregamento de secretária com tomada USB + cabo USB incluído
Dimensões 50x190 mm

COB LED - cri 96+
3 COLORI
2700K 4500K 6500K

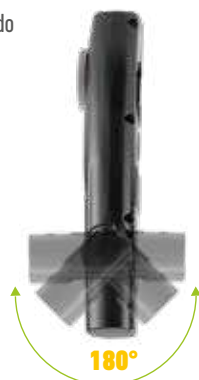

BASE MAGNÉTICA + SUPER ÍMAN NA PARTE DE TRÁS



LENTE SUBSTITUÍVEL



GANCHO EXTRAÍVEL



FG 236

335,00€

199,00€

LUZ LED RECARREGÁVEL PARA CONTROLE DE CORES COM ALTO ÍNDICE DE REPRODUÇÃO DE CORES (CRI 96+)

Elevado índice de restituição de cor CRI 96+
 5 opções de temperatura de cor
 2700K/3500K/4500K/5500K/6500K
 Base giratória de 180
 Função de memória dos parâmetros de última utilização
 Classificação IP65 de resistência à água e ao pó
 Grau de resistência ao impacto IK07
 Acessório de tripé não incluído
 Dimensões 115x190 mm



PAINEL DE CONTROLO



CARREGADOR DE LIBERTAÇÃO RÁPIDA COM CABO DE 5 M



2700K 3500K 4500K 5500K 6500K



FG 236/SU

100,00€

59,00€

TRIPÉ PARA FAROL DE LED FG 236

Altura 476 mm (fechado) - 1440 mm (aberto)
 Número de extensões de pés 3
 Carga máxima 2 kg
 Peso líquido: 1098 gr



FG 225/SK1.5

300,00€

159,00€

ENROLADOR DE CABO ELÉTRICO AUTOMÁTICO, 15M COM CABO 3GX1.5 MM²

Comprimento do cabo de entrada 1,20 M

15m x 3G 1.5mm² 1000W
 230V AC 2000W



LIMITADOR DE REENTRADA PARA DETENER LA CARRERA



SISTEMA DE BLOQUEIO EM QUALQUER COMPRIMENTO



FG 225/SK2.5

370,00€

179,00€

ENROLADOR DE CABO ELÉTRICO AUTOMÁTICO, 15M COM CABO 3GX2.5 MM²

Comprimento do cabo de entrada 1,20 M

15m x 3G 2.5mm² 1600W
 230V AC 3200W



SUPORTE DE PAREDE AJUSTÁVEL A 360°



POWER TOOLS

DESEMPENHO
CONFIABILIDADE
QUALIDADE

BRUSHLESS
MOTOR



Descubra a nova linha de ferramentas elétricas Fasano Tools concebidas para satisfazer as necessidades do utilizador profissional. Duas linhas diferentes, com baterias de lítio com tensões de 14,4 V e 18 V respetivamente, desenvolvidas

para otimizar o desempenho das ferramentas, que tiram partido de tecnologias de última geração e estão equipadas com células de alta qualidade. Todas as novas ferramentas sem fios Fasano Tools estão equipadas com um motor sem escovas (brushless).

DESEMPENHO

Os motores sem escovas desperdiçam menos energia, o que lhes permite fornecer mais potência com um desempenho ideal, mesmo em aplicações exigentes.

EFICIÊNCIA

O motor sem escovas opera de forma mais eficiente, melhorando a autonomia das ferramentas durante a utilização e prolongando a vida útil da ferramenta ao longo do tempo.

DESIGN COMPACTO

O design mais compacto do motor sem escovas torna as ferramentas mais leves e confortáveis de utilizar, mesmo nos contextos mais difíceis, onde o espaço é limitado, reduzindo a fadiga e melhorando a ergonomia.

FUNCIONALIDADE,
COMPACTAÇÃO,
VERSATILIDADE

Li-ion
2Ah

A plataforma de 14,4 V é composta por 7 modelos, todos compatíveis com a mesma bateria de 14,4 V para uma grande versatilidade em diferentes situações de utilização.

Graças ao seu design compacto, estas ferramentas permitem-lhe trabalhar confortavelmente e o seu desempenho é adequado para completar o trabalho no menor tempo possível.

As ferramentas Fasano Tools 14,4 V disponíveis são: três roquetes com ligações de 1/2", 3/8", 1/4"; duas mini retificadoras com cabeças retas e angulares e duas lixadoras de cinta com cintas de diferentes tamanhos.

FAIXA

14.4V





MÁXIMO DESEMPENHO

A plataforma de 18 V inclui ferramentas capazes de oferecer o mais elevado desempenho para executar as aplicações mais exigentes.



FAIXA

18V

**Li-ion
5Ah**

Bateria 18V 5Ah para garantir um elevado desempenho com 4 LEDs para indicar autonomia residual.

Luz LED potente para uma iluminação eficiente da área de trabalho.

PARAFUSO

PAR MÉDIO

POR ALTO



FG 305/LT2 FG 310/LT2 FG 315/LT2 FG 320/LT2

	FG 305/LT2	FG 310/LT2	FG 315/LT2	FG 320/LT2
TECNOLOGIA DO MOTOR	Brushless	Brushless	Brushless	Brushless
ATAQUE	1/2"	1/2"	1/2"	3/4"
BATERIA	18V - 5Ah	18V - 5Ah	18V - 5Ah	18V - 5Ah
TORQUE MÁXIMO PARAFUSADO (NM)	470	740	950	950
TORQUE MÁXIMO DESPARAFUSADO (NM)	510	880	1800	1800
Ø PARAFUSO	M10 - M16	M16-M22	M12-M32	M12-M32
VEL. VAZIO (RPM)	0-2500	0-2200	0-1800	0-1750
PESO COM BATERIA (GR)	1.890	2.360	3.450	3.560

PARAFUSANDO/PERFURAÇÃO

FG 330/LT2

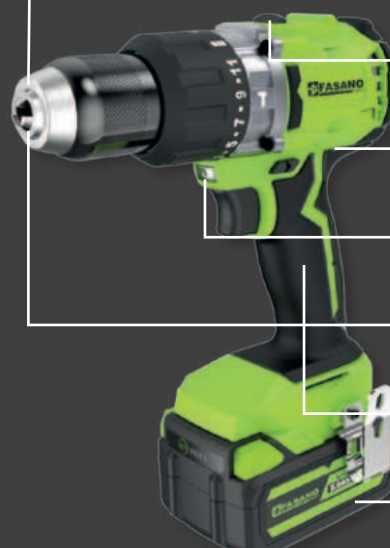

MANDRIL AUTOBLOQUEANTE EM AÇO 13mm

VELOCIDADE SEM CARGA 0-550/2000 rpm

MOTOR SEM ESCOVAS

LUZ LED PARA ILUMINAR A ÁREA DE TRABALHO

PERFURAÇÃO MÁXIMA 89/13/16mm madeira/metal/alvenaria

ALÇA ERGONÓMICA REVESTIDO A BORRACHA

BATERIA 18V - 5Ah



Caixa em ABS com pega em borracha antiderrapante. Ideal para o transporte e armazenamento prático de ferramentas e do seu equipamento de série (bateria dupla de 18 V-5 Ah, carregador e gancho para cinto).



FAIXA
18V

POWER
TOOLS

FG 305/LT2

~~975,00€~~

499,00€

NEW

CHAVE DE IMPACTO 1/2" - 18V

Motor sem escovas

Binário máximo de 470 Nm ao aparafusar e 510 Nm ao desaparafusar

4 modos de funcionamento para parafusar

2 modos de funcionamento para desaparafusar

Função de controlo do aperto para controlo do aperto

Modo de remoção suave do parafuso, evita que o parafuso caia ao desaparafusar

Design compacto

LED triplo para iluminar a área de trabalho

Âmbito de fornecimento: 2 baterias de íões de lítio 18V - 5Ah, carregador de bateria, gancho metálico para cinto, mala de transporte em ABS com clipe metálico de fecho



DIMENSÕES



LED TRIPLÓ

1/2"

18V

BRUSHLESS
MOTOR

LI-ION
BATTERY

CE

FG 310/LT2

~~1075,00€~~

539,00€

NEW

CHAVE DE IMPACTO 1/2" - 18V

Motor sem escovas

Binário máximo de 740 Nm ao aparafusar e 880 Nm ao desaparafusar

4 modos de funcionamento para parafusar

2 modos de funcionamento para desaparafusar

Função de controlo do aperto para controlo do aperto

Modo de remoção suave do parafuso, evita que o parafuso caia ao desaparafusar

Design compacto

LED triplo para iluminar a área de trabalho

Âmbito de fornecimento: 2 baterias de íões de lítio 18V - 5Ah, carregador de bateria, gancho metálico para cinto, mala de transporte em ABS com clipe metálico de fecho



DIMENSÕES

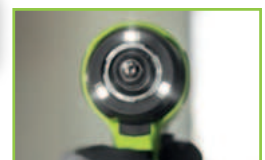

LED TRIPLÓ

1/2"

18V

BRUSHLESS
MOTOR

LI-ION
BATTERY

CE

FG 315/LT2

1.175,00€

599,00€

NEW

CHAVE DE IMPACTO 1/2" - 18V

Motor sem escovas
Binário máximo de 950 Nm ao aparafusar e 1800 Nm ao desaparafusar
4 modos de funcionamento para parafusar
2 modos de funcionamento para desaparafusar
Função de controlo do aperto para controlo do aperto
Modo de remoção suave do parafuso, evita que o parafuso caia ao desaparafusar
Design compacto
LED tripla para iluminar a área de trabalho
Âmbito de fornecimento: 2 baterias de iões de lítio 18V - 5Ah, carregador de bateria, gancho metálico para cinto, mala de transporte em ABS com clipe metálico de fecho



DIMENSÕES



LED TRIPLA

1/2" 18V BRUSHLESS MOTOR LI-ION BATTERY CE



DIMENSÕES



LED TRIPLA

FG 320/LT2

1.255,00€

649,00€

NEW

CHAVE DE IMPACTO 3/4" - 18V

Motor sem escovas
Binário máximo de 950 Nm ao aparafusar e 1800 Nm ao desaparafusar
4 modos de funcionamento para parafusar
2 modos de funcionamento para desaparafusar
Função de controlo do aperto para controlo do aperto
Modo de remoção suave do parafuso, evita que o parafuso caia ao desaparafusar
Design compacto
LED tripla para iluminar a área de trabalho
Âmbito de fornecimento: 2 baterias de iões de lítio 18V - 5Ah, carregador de bateria, gancho metálico para cinto, mala de transporte em ABS com clipe metálico de fecho



3/4" 18V BRUSHLESS MOTOR LI-ION BATTERY CE

FG 330/LT2

985,00€

549,00€

NEW

BERBEQUIM COM PERCUSSÃO - 18V

Motor sem escovas
Alto desempenho, até 135 Nm de binário máximo
Mandril metálico sem chave de 13 mm
11 posições de ajuste de binário
Velocidade dupla
Percussão máxima: 32000 Rpm
Luz LED para iluminar a área de trabalho
Embraiagem eletrónica
Sistema Anti Kick Back para máximo controlo da ferramenta
Âmbito de fornecimento: 2 baterias de iões de lítio 18V - 5Ah, carregador de bateria, gancho metálico para cinto, pega lateral, mala de transporte em ABS com clipe metálico de fecho



18V BRUSHLESS MOTOR LI-ION BATTERY CE



DIMENSÕES



ALTO DESEMPENHO EM TODAS AS APLICAÇÕES



FAIXA

14.4V

FG 360/LT1

~~505,00€~~

299,00€

NEW

ROQUETE 1/2" - 14,4V

Motor sem escovas

Elevado desempenho, binário máximo até 95 Nm

Velocidade em vazio 300 RPM

Cabeça fina

Velocidade variável

Luz LED para iluminar a área de trabalho

Âmbito de fornecimento: 1 bateria de lítio 14,4V - 2Ah, 1

carregador de bateria, mala de transporte em ABS com clip de

fecho metálico

14.4V

BRUSHLESS
MOTOR

CE



DIMENSÕES

CABEÇA FINA PARA MÁXIMA
ACESSIBILIDADE

FG 363/LT1

~~515,00€~~

309,00€

NEW

ROQUETE 3/8" - 14,4V

Motor sem escovas

Elevado desempenho, binário máximo até 95 Nm

Velocidade em vazio 550 RPM

Cabeça fina

Velocidade variável

Luz LED para iluminar a área de trabalho

Âmbito de fornecimento: 1 bateria de lítio 14,4V - 2Ah, 1

carregador de bateria, mala de transporte em ABS com clip de

fecho metálico

14.4V

BRUSHLESS
MOTOR

CE



DIMENSÕES

DESENHO LONGO PARA ACEDER AOS
LOCAIS MAIS DIFÍCEIS

FG 366/LT1

~~535,00€~~

319,00€

NEW

ROQUETE LONGO DE 1/4" - 14,4V

Motor sem escovas

Máxima eficiência, até 61 Nm de binário máximo a uma

velocidade de 500 rpm

Design longo

Velocidade variável

Luz LED para iluminar a área de trabalho

Âmbito de fornecimento: 1 bateria de lítio 14,4V - 2Ah, 1

carregador de bateria, mala de transporte em ABS com clip de

fecho metálico

14.4V

BRUSHLESS
MOTOR

CE

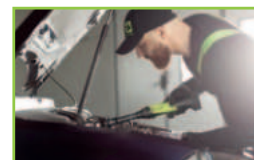

DIMENSÕES

DESENHO LONGO PARA ACEDER AOS
LOCAIS MAIS DIFÍCEIS

FG 370/LT1

~~620,00€~~

369,00€

NEW

LIXADORA DE CINTA - 14,4V 10X330MM

Motor sem escovas
Correia 10x330 mm
Velocidade variável
Velocidade em vazio 20000 RPM
Velocidade da correia: 0-1327 m/min
Design leve e ergonómico
Luz LED para iluminar a área de trabalho
Âmbito de fornecimento: 1 bateria de lítio 14,4V - 2Ah, 1 carregador de bateria, mala de transporte em ABS com clipe de fecho metálico

14.4V

BRUSHLESS MOTOR

LI-ION BATTERY

CE



DIMENSÕES



BRAÇO GIRATÓRIO DE 360°

FG 373/LT1

~~610,00€~~

359,00€

NEW

LIXADORA DE CINTA - 14,4V 20X520MM

Motor sem escovas
Correia 20x520 mm
Velocidade variável
Velocidade em vazio 20000 RPM
Velocidade da correia: 0-1327 m/min
Design leve e ergonómico
Luz LED para iluminar a área de trabalho
Âmbito de fornecimento: 1 bateria de lítio 14,4V - 2Ah, 1 carregador de bateria, mala de transporte em ABS com clipe de fecho metálico

14.4V

BRUSHLESS MOTOR

LI-ION BATTERY

CE



DIMENSÕES



BRAÇO GIRATÓRIO DE 360°

FG 380/LT1

~~530,00€~~

319,00€

NEW

MINI MOINHO RETO 14,4V

Motor sem escovas
4 velocidades
Design compacto
Velocidade em vazio 24500 RPM
Cabeça reta com ligação de pinça de 6 mm
Diâmetro máximo do disco 55 mm
Luz LED para iluminar a área de trabalho
Âmbito de fornecimento: 1 bateria de íões de lítio 14,4V - 2Ah, 1 carregador de bateria, mala de transporte em ABS com clipe de fecho metálico

14.4V

BRUSHLESS MOTOR

LI-ION BATTERY

CE



DIMENSÕES



PAINEL DE CONTROLO DA VELOCIDADE DE TRABALHO

FG 383/LT1

~~535,00€~~

299,00€

NEW

MINI REBARBADORA 14,4V

Motor sem escovas
4 velocidades - Design compacto
Velocidade em vazio 24500 RPM
Cabeça reta com ligação de pinça de 6 mm
Diâmetro máximo do disco 55 mm
Luz LED para iluminar a área de trabalho
Âmbito de fornecimento: 1 bateria de íões de lítio 14,4V - 2Ah, 1 carregador de bateria, mala de transporte em ABS com clipe de fecho metálico

14.4V

BRUSHLESS MOTOR

LI-ION BATTERY

CE



DIMENSÕES



PAINEL DE CONTROLO DA VELOCIDADE DE TRABALHO



EXTRACTORES

FG 162/S3

366,00€

229,00€

JOGO DE 3 EXTRACTORES UNIVERSAIS

27-90 mm, 27-135 mm, 35-155 mm



EXTRATOR UNIVERSAL DE 2 GRELHAS

Modelo tipo tesoura

Mordentes ajustáveis em aço cromo-vanádio

Punho exterior

Parafuso em aço cromo-vanádio



CÓDIGO	A/MM	€/LISTA	€/PROMO
FG 162/FR1	90	155,00€	89,90€
FG 162/FR2	125	205,00€	119,00€
FG 162/FR3	125	237,00€	139,00€

EXTRACTOR DE 2 PERNAS FINAS

Mordentes intercambiáveis super-finos de 2 mm em aço cromo-vanádio

Punho interno e externo

Parafuso em aço cromo-vanádio



CÓDIGO	A/MM	B/MM	C/MM	€/LISTA	€/PROMO
FG 168/EF1	110	140	186	325,00€	195,00€
FG 168/EF2	195	140	186	335,00€	205,00€

EXTRACTOR DE 2/3 PERNAS

Equipado com 3 mordentes para agarrar no interior e 3 mordentes para agarrar no exterior

Mordentes em aço cromo-vanádio



CÓDIGO	Ø INTERNA	Ø ESTERNA	€/LISTA	€/PROMO
FG 165/IE1	25-100mm	0-75mm	320,00€	189,00€
FG 165/IE2	45-150mm	40-130mm	760,00€	459,00€

EXTRACTOR DE PERCUSSÃO
M12x1.5



CÓDIGO	PER	€/LISTA	€/PROMO
FG 165/MB1	FG 165/IE1	170,00€	99,00€
FG 165/MB2	FG 165/IE2	330,00€	199,00€

FG 168SD/S4

~~155,00€~~ **95,00€**

JOGO 4 QUEBRA PORCAS

Conteúdo: FG 164/SD1 - SD4



FG 168/S25

~~144,00€~~ **79,00€**

EXTRACTORES CÔNICOS DE PARAFUSOS EM AÇO LIGADO

Equipado com guias internas e externas e brocas
Utilização: parafusos com diâmetro 6-16mm

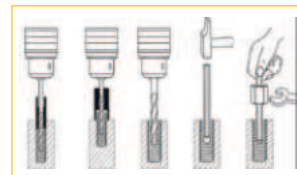

FG 168/S9

~~188,00€~~ **119,00€**

JOGO 9 SACA PERNOS COM ROLETE

Conteúdo: FG 168/R6 - R16



JOGO DE EXTRAÇÃO PARA PORCAS DIREITAS DANIFICADAS COM LIGAÇÃO DE 1/2"

Fornecido num suporte em ABS suspensível com ganchos de fixação e mecanismo de interruptor de limite anti-queda

1/2"



CÓDIGO	CONTENUTO	€/LISTA	€/PROMO
FG 168A/S5	22, 24, 27, 30, 32 mm	115,00€	69,00€
FG 168A/S13	8, 9, 10, 11, 12, 13, 14, 15, 16, 17, 18, 19, 21 mm	220,00€	129,00€

FG 182/S5B

~~475,00€~~ **285,00€**

JOGO EXTRACTORES DE PERCUSSÃO E ACESSÓRIOS



FG 168EP/S5

~~35,00€~~ **19,90€**

EXTRACTORES CÔNICOS DE PARAFUSOS EM AÇO LIGADO

Inserção por percussão



FG 182/S14

~~248,00€~~ **149,00€**

JOGO DE EXTRACTORES DE ROLAMENTOS DE ESFERAS

Ø/mm 5,6,8,9,11,12,5





FERRAMENTAS DE AR

FGA 307

250,00€

149,00€

CHAVE DE IMPACTO-1/2"

- 1.200
- 746 Nm
- 610 Nm
- 136 L/min
- 9.500 RPM
- 6:2 Bar



CE



Martello singolo



FGA 307/AN

340,00€

189,00€

CHAVE DE IMPACTO ANGULAR -1/2"

- 1.150
- 420 Nm
- 244 Nm
- 113 L/min
- 9.000 RPM
- 6:2 Bar



CE



Martello singolo



FGA 309

300,00€

179,00€

CHAVE DE IMPACTO-1/2"

- 1.900
- 1.085 Nm
- 746 Nm
- 151 L/min
- 7.300 RPM
- 6:2 Bar



CE



Martello doppio



FGA 312

380,00€

199,00€

CHAVE DE IMPACTO-1/2"

- 2.000
- 1.130 Nm
- 950 Nm
- 136 L/min
- 7.500 RPM
- 6:2 Bar



CE



Martello doppio



FGA 309/S4

390,00€

239,00€

JOGO CHAVE DE IMPACTO FGA 309 + 03 CHAVES DE PORCAS PARA RODAS

CE



FGA 309/S10

410,00€

249,00€

JOGO CHAVE DE IMPACTO FGA 309 + 9 CHAVES DE CAIXA REFORÇADO

CE



FGA 302

240,00€

139,00€

CHAVE DE IMPACTO-1/2"

CE



Martello doppio

2.100

880 Nm

745 Nm

127 L/min

7.800 RPM

6:2 Bar

FGA 290

205,00€

119,00€

ROQUETE PNEUMÁTICO 1/4"

Sistema de reversibilidade integrado na cabeça

Sistema de acionamento da pinça

Ligação de ar 1/4" gás

Mangueira de ar interna Ø 10mm (3/8")

CE



FGA 291/D

188,00€

119,00€

MINI ROQUETE PNEUMÁTICO 1/4"

Ligação de ar 1/4" gás

Mangueira de ar interna Ø 10mm (3/8")

CE



NEW

FGA 292/B

218,00€

139,00€

ROQUETE PNEUMÁTICO 1/2"

CE



244 Nm
MAX TORQUE

300 RPM

3/8" 10mm

1.300

105 L/min

6:2 Bar



FERRAMENTAS PNEUMÁTICAS

FGA 316/L

~~830,00€~~ **499,00€**

CHAVE DE IMPACTO DE 3/4"
- ÁRVORE LONGO 6"

FGA 316

~~760,00€~~ **449,00€**

CHAVE DE IMPACTO -3/4"



MARTELO DUPLO

CE



FGA 319/L

~~1.350,00€~~ **799,00€**

CHAVE DE IMPACTO DE 1"
- ÁRVORE LONGO 6"

FGA 319

~~1.250,00€~~ **699,00€**

CHAVE DE IMPACTO -1"



Pin-less

CE



FGA 321/B

~~1.250,00€~~ **669,00€**

CHAVE DE IMPACTO DE 1"
- ÁRVORE LONGO 6"

FGA 321

~~1.200,00€~~ **649,00€**

CHAVE DE IMPACTO -1"



MARTELO DUPLO

2.983 Nm

MAX TORQUE

CE



FGA 321/C

~~1.350,00€~~ **749,00€**

CHAVE DE IMPACTO DE 1"
- ÁRVORE LONGO 6"



Pin-less

CE



IDEAL PARA USO INTENSIVO

FGA 390

~~155,00€~~

89,00€

MANÔMETRO

Corpo em alumínio niquelado
Revestimento de borracha resistente ao óleo
Manômetro Ø80 (0-10bar)
Proteção contra sobrepresão
Alavanca de drenagem/insuflação de duas posições
Comprimento do tubo: 500 mm



FGA 322

~~140,00€~~

85,00€

VULCANIZER PNEUMÁTICO



FGA 332

~~145,00€~~

89,00€

BERBEQUIM REVERSÍVEL - BUCHA DE APERTO RÁPIDO: 1-10MM



FGA 333

~~185,00€~~

109,00€

BERBEQUIM REVERSÍVEL - BUCHA DE APERTO RÁPIDO: 1-13MM



FGA 333/AC

~~210,00€~~

129,00€

BERBEQUIM REVERSÍVEL - BUCHA DE APERTO EM AÇO: 1-13MM



FGA 332/AN

~~180,00€~~

109,00€

BERBEQUIM ANGULAR - BUCHA DE APERTO RÁPIDO: 1-10MM





FGA 340

295,00€

169,00€

LIXADEIRA DE DISCO ORBITAL

- Ø orbital: 5mm - con 15 agujeros

152mm	11.000 RPM	900
45.2 L/min	1/2" 13mm	6:2 Bar



150mm	11.000 RPM	800
46 L/min	1/4" 6mm	6:2 Bar



FGA 340/B

295,00€

169,00€

LIXADEIRA DE DISCO ORBITAL

- Ø orbital: 2.5mm - con 15 agujeros

FGA 341

650,00€

399,00€

LIXADEIRA MULTIUSOS

Sistema de aspiração integrado no corpo da máquina

Suporte lateral giratório de 180

Ligação de ar 1/4" para gás

Mangueira de ar interna Ø 10mm (3/8")



FGA 342/B

285,00€

169,00€

LIXADEIRA DE DISCO ORBITAL

Órbita Ø: 2.5 mm

Almofada de apoio 3 furos



75mm	11.000 RPM	500
46 L/min	1/4" 6mm	6:2 Bar



FGA 342

220,00€

129,00€

LIXADEIRA DE DISCO ORBITAL

Diâmetro da órbita: 2 mm

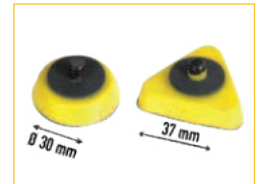

13.000 RPM	45 L/min	3/8" 10mm	500
------------	----------	-----------	-----

FGA 343/N10

230,00€

139,00€

LIXADEIRA DE CINTA

Tamanho da fita: 10x330mm



(0.70) Hp	18.000 RPM	800	90 L/min	1/4" 6mm	6:2 Bar
-----------	------------	-----	----------	----------	---------

FGA 343/N20

295,00€

179,00€

LIXADEIRA DE CINTA

Tamanho da fita: 20x520mm



(0.70) Hp	18.000 RPM	960	107 L/min	1/4" 6mm	6:2 Bar
-----------	------------	-----	-----------	----------	---------

FGA 337

125,00€

79,00€

LIXADEIRA PARA REMOVER BORRACHA



FGA 330

295,00€

179,00€

SERRA PNEUMÁTICA

CE



FGA 339

355,00€

199,00€

REBARBADORA - Ø DISCO: 115MM

Capacidade do disco: 115 mm

Sistema de regulação da velocidade da pinça

Ligação de ar 1/4" gás

Mangueira de ar interna Ø 10mm (3/8")

CE



FGA 346/B

220,00€

139,00€

MICRO RECTICADORA

Capacidade da pinça: 3 mm

CE



FGA 335

210,00€

119,00€

REBITADORA PNEUMÁTICA

4 cabeças intermutáveis

CE



FGA 336

600,00€

379,00€

REBITADORA PNEUMÁTICA

4 cabeças intermutáveis

CE





FGA 338

125,00€

75,00€

RECTIFICADORA PNEUMÁTICA



LÂMINAS EM IN KEVLAR



FGA 334

145,00€

89,00€

RECTIFICADORA PNEUMÁTICA



LÂMINAS EM IN KEVLAR



FGA 338/B

160,00€

99,00€

RECTIFICADORA PNEUMÁTICA DE BAIXA VELOCIDADE



LÂMINAS EM IN KEVLAR



FGA 334/AN115

185,00€

109,00€

RECTIFICADORA PNEUMÁTICA-115°



LÂMINAS EM IN KEVLAR



FGA 338/AN

170,00€

99,00€

RECTIFICADORA PNEUMÁTICA ANGULAR



LÂMINAS EM IN KEVLAR



FGA 334/AN

185,00€

109,00€

RECTIFICADORA PNEUMÁTICA ANGULAR



LÂMINAS EM IN KEVLAR



FGA 338/L

165,00€

99,00€

RECTIFICADORA PNEUMÁTICA LONGA



LÂMINAS EM IN KEVLAR



FGA 334/L

185,00€

109,00€

RECTIFICADORA PNEUMÁTICA LONGA



LÂMINAS EM IN KEVLAR





ENROLADOR TUBO AUTOMÁTICO

CE



TUBO DE MALHA DE POLIURETANO
SUPORTE DE PAREDE AJUSTÁVEL DE 360°



FGA 383/AR15

275,00€

149,00€

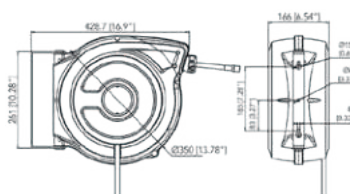

ENROLADOR TUBO AUTOMÁTICO
PARA AR COMPRIMIDO -15MT
- ø tubo interno: 8mm

FGA 385/AR15

360,00€

199,00€

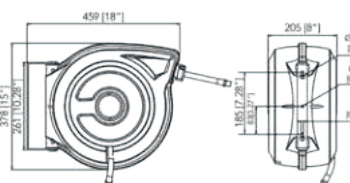

ENROLADOR TUBO AUTOMÁTICO
PARA AR COMPRIMIDO -15MT
- ø tubo interno: 10mm

GUIA DE DESLIZAMENTO
AUTOMÁTICO

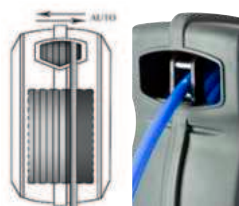

SISTEMA DE BLOQUEIO EM
QUALQUER COMPRIMENTO

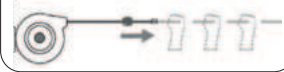

REBOBINAMENTO EM
VELOCIDADE CONTROLADA



FGA 419

23,50€

14,90€

SOPRADOR

Válvula de abertura progressiva
Corpo em alumínio niquelado
Pega de borracha antiderrapante



CE

FGA 416

22,00€

13,90€

SOPRADOR

Válvula de abertura progressiva
Rosca em latão



CE





IL MEGLIO DEL MADE IN ITALY



Os nossos carrinhos são o resultado de intenso trabalho de investigação, desenvolvimento, design e produção interna.



QUALIDADE, ROBUSTEZ E A ATENÇÃO AOS DETALHES SÃO AS CARACTERÍSTICAS DISTINTIVAS DOS NOSSOS CARRINHOS DE FERRAMENTAS

Uma gama completa de modelos que diferem no design, cores e características para oferecer ao utilizador as melhores soluções possíveis de acordo com as suas necessidades

FG 102



FG 100



FG 122



NEW

FG 150



GAVETAS COMPATÍVEIS COM TODOS OS TERMOFORMADOS FERRAMENTAS FASANO



STANDARD

DISPONÍVEL COM 5-6-7-8 GAVETAS EM 5 VARIANTES DE CORES + 14 VARIANTES DE CORES FG 100 BICOLOR

FG 104



FG 124



NEW

XL

DISPONÍVEL COM 6-7 GAVETAS EM 4 VARIANTES DE CORES



FG 105



FG 109



FG 160



FG 162



NEW

CAPACIDADE MÁXIMA 2400Kg

COM APÊNDICE LATERAL

DISPONÍVEL EM 4 VARIAÇÕES DE CORES

COM SUPERFÍCIE DE TRABALHO ÚNICA

DISPONÍVEL EM 4 VARIAÇÕES DE CORES COM 14 GAVETAS

FG 122



CARRO COM 5 GAVETAS FG 122

Caixa electrosoldada
 Guias telescópicas capacidade 45Kg
 4 rodas de borracha vulcanizada Ø125mm (2 giratórias, 1 com travão)
 Piso superior de borracha com acabamento em carbono 3D
 Sistema de fecho centralizado
 Gavetas equipadas com tapetes anti-riscos e previsão de divisórias interiores
 Abertura total das gavetas
 Puxador em aço inoxidável
 Capacidade maxima gavetas: 45Kg



CÓDIGO				Gavetas	€/lista	€/PROMO
FG 122V/5G	FG 122D/5G	FG 122B/5G	FG 122R/5G	5	1.030,00€	499,00€
FG 122V/6G	FG 122D/6G	FG 122B/6G	FG 122R/6G	6	1.080,00€	529,00€
FG 122V/7G	FG 122D/7G	FG 122B/7G	FG 122R/7G	7	1.150,00€	599,00€

NEW

800 Kg
PORTATA
STATICA



TOP SUPERIOR EM BORRACHA COM ACABAMENTO EM CARBONO 3D

MADE IN ITALY



NOVO SISTEMA DE PRATELEIRAS PARA MAIS ABERTURA MAIS ESTÁVEL DA GAVETA



4 RODAS DE BORRACHA VULCANIZADA Ø125MM

FG 124



CARRO COM 6 GAVETAS MODELO FG 124

Caixa electrosoldada
 Guias telescópicas capacidade 45Kg
 4 rodas de borracha vulcanizada Ø125mm (2 giratórias, 1 com travão)
 Piso superior de borracha com acabamento em carbono 3D
 Sistema de fecho centralizado
 Gavetas equipadas com tapetes anti-riscos e previsão de divisórias interiores
 Abertura total das gavetas
 Puxador em aço inoxidável
 Capacidade maxima gavetas: 60kg



CÓDIGO				Gavetas	€/lista	€/PROMO
FG 124V/6G	FG 124D/6G	FG 124B/6G	FG 124R/6G	6	1.300,00€	639,00€
FG 124V/7G	FG 124D/7G	FG 124B/7G	FG 124R/7G	7	1.400,00€	689,00€

NEW

1000 Kg
PORTATA
STATICA

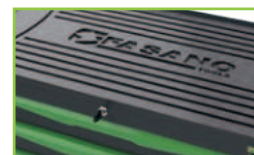

TOP SUPERIOR EM BORRACHA COM ACABAMENTO EM CARBONO 3D

MADE IN ITALY



NOVO SISTEMA DE PRATELEIRAS PARA MAIS ABERTURA MAIS ESTÁVEL DA GAVETA



4 RODAS DE BORRACHA VULCANIZADA Ø125MM

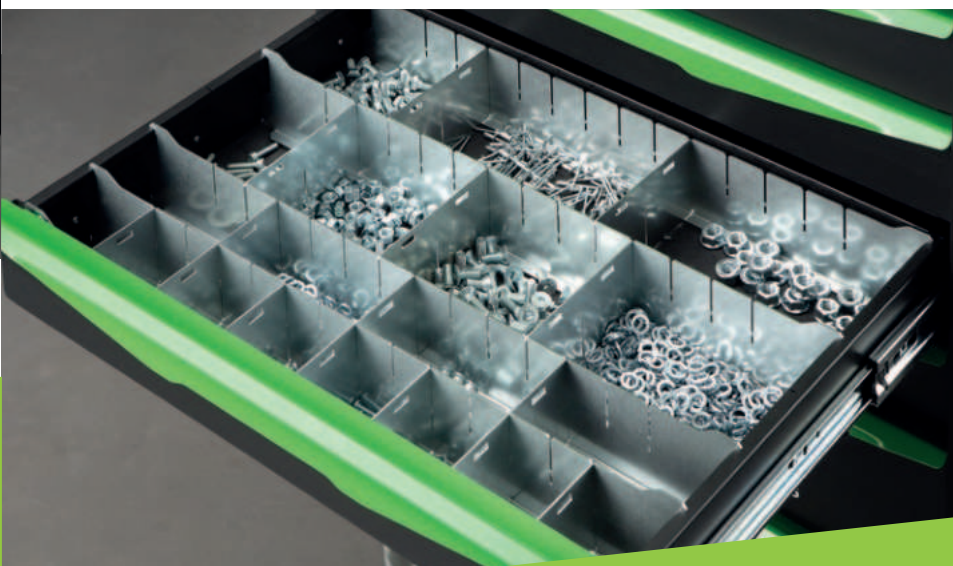

DIVISORES PARA GAVETA

VER PÁGINA 397 DO CATÁLOGO SABER AS CONFIGURAÇÕES DISPONÍVEL





FG 102

CARRO DE FERRAMENTAS MODELO FG 102

Corrediças telescópicas com sistema de acoplamento automático
 4 rodas de borracha vulcanizada Ø125mm (2 fixas, 1 giratória e 1 giratória com travão)
 Pega lateral em aço inoxidável
 Sistema de fecho centralizado
 Gavetas equipadas com tapete de borracha interior
 Tampo em espuma de borracha
 Capacidade máxima gavetas: 45Kg

800 Kg PORTATA
STATICA



4 RODAS Ø125

MADE IN ITALY



TOP DE BORRACHA



PUXADOR DE AÇO INOXIDÁVEL



CÓDIGO				Gavetas	€/lista	€/PROMO
FG 102V/5G	FG 102B/5G	FG 102R/5G	FG 102D/5G	5	880,00€	469,00€
FG 102V/6G	FG 102B/6G	FG 102R/6G	FG 102D/6G	6	940,00€	499,00€
FG 102V/7G	FG 102B/7G	FG 102R/7G	FG 102D/7G	7	1.010,00€	529,00€
FG 102V/8G	FG 102B/8G	FG 102R/8G	FG 102D/8G	8	1.100,00€	559,00€

FG 104

CARRO DE FERRAMENTAS MODELO FG 104

Corrediças telescópicas com sistema de acoplamento automático
 4 rodas de borracha vulcanizada Ø125mm (2 fixas, 1 giratória e 1 giratória com travão)
 Pega lateral em aço inoxidável
 Sistema de fecho centralizado
 Gavetas equipadas com tapete de borracha interior
 Tampo em espuma de borracha
 Capacidade máxima gavetas: 60Kg

1000 Kg PORTATA
STATICA



TOP DE BORRACHA

MADE IN ITALY



PUXADOR DE AÇO INOXIDÁVEL



FECHO CENTRALIZADO



CÓDIGO				Gavetas	€/lista	€/PROMO
FG 104V/6G	FG 104B/6G	FG 104R/6G	FG 104D/6G	6	1.150,00€	579,00€
FG 104V/7G	FG 104B/7G	FG 104R/7G	FG 104D/7G	7	1.250,00€	599,00€



FG 100



CARRO DE FERRAMENTAS BICOLOR COM 7 GAVETAS MOD. FG 100

Corrediças telescópicas com sistema de acoplamento automático
 4 rodas de borracha vulcanizada Ø125mm (2 fixas, 1 giratória, 1 giratória com travão)
 Prateleira superior em ABS com pega integrada
 Fecho lateral centralizado
 Porta-garrafas lateral de série
 Painéis laterais com orifícios para pendurar ganchos para ferramentas
 5 gavetas 580x398x75 mm e 2 gavetas 580x398x135 mm
 Abertura total das gavetas
 Capacidade máxima gavetas: 45Kg

800 Kg
PORTATA
STATICA

MADE IN ITALY



CÓDIGO	RAL	€/lista	€/PROMO
FG 100VD/7T	6018+7021	1.350,00€	699,00€
FG 100VW/7T	6018+9016	1.350,00€	699,00€
FG 100BW/7T	5002+9016	1.350,00€	699,00€
FG 100BD/7T	5002+7021	1.350,00€	699,00€
FG 100RD/7T	3001+7021	1.350,00€	699,00€
FG 100RY/7T	3001+1018	1.350,00€	699,00€
FG 100CW/7T	5012+9016	1.350,00€	699,00€
FG 100MA/7T	3004+9016	1.350,00€	699,00€
FG 100RW/7T	3001+9016	1.350,00€	699,00€
FG 100RB/7T	3001+5002	1.350,00€	699,00€
FG 100DP/7T	7021+3015	1.350,00€	699,00€
FG 100DW/7T	7021+9016	1.350,00€	699,00€
FG 100BY/7T	5002+1018	1.350,00€	699,00€
FG 100GW/7T	3004+9016	1.350,00€	699,00€

FG 100



CARRO DE FERRAMENTAS MODELO FG 100

Corrediças telescópicas com sistema de acoplamento automático
 4 rodas de borracha vulcanizada Ø125mm (2 fixas e 2 giratórias)
 Fechos laterais centralizados
 Prateleira superior em ABS e porta-ferramentas laterais
 Porta-garrafas lateral de série
 Painéis laterais com orifícios para pendurar ganchos para ferramentas
 Capacidade máxima gavetas: 45Kg

800 Kg
PORTATA
STATICA

MADE IN ITALY



SISTEMA DE BLOQUEIO LATERAL



NOVA PEGA LATERAL DE AÇO

CÓDIGO	Gavetas	€/lista	€/PROMO
FG 100V/5T	5	1.000,00€	519,00€
FG 100V/6T	6	1.050,00€	539,00€
FG 100V/7T	7	1.100,00€	559,00€



GAVETA COM ABERTURA TOTAL





FG 105



CARRO PORTA FERRAMENTAS COM ARMÁRIO LATERAL

Corrediças telescópicas com sistema de acoplamento automático
 4 rodas de borracha vulcanizada Ø125mm (2 fixas, 1 giratória e 1 giratória com travão)
 Pega lateral em aço
 Sistema de fecho centralizado
 Gavetas equipadas com tapete de borracha interior
 Tampo em espuma de borracha
 Prateleiras interiores amovíveis e reguláveis
 Porta com abertura de 90° e fechadura com chave
 Capacidade máxima gavetas: 45Kg



PRATELEIRAS INTERNAS AJUSTÁVEIS

MADE IN ITALY

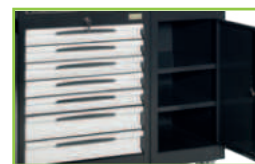

PORTA DE ABERTURA DE 90° BLOQUEÁVEL



CÓDIGO				Gavetas	€/lista	€/PROMO
FG 105V/5G	FG 105B/5G	FG 105R/5G	FG 105D/5G	5	1.300,00€	689,00€
FG 105V/6G	FG 105B/6G	FG 105R/6G	FG 105D/6G	6	1.400,00€	739,00€
FG 105V/7G	FG 105B/7G	FG 105R/7G	FG 105D/7G	7	1.450,00€	769,00€

FG 109



CARRO DE FERRAMENTAS COM APÊNDICE LATERAL

Corrediças telescópicas com sistema de acoplamento automático
 4 rodas de borracha vulcanizada Ø125mm (2 fixas, 1 giratória e 1 giratória com travão)
 Pega lateral em aço
 Sistema de fecho centralizado
 Gavetas equipadas com tapete de borracha interior
 Tampo em espuma de borracha
 Prateleiras interiores amovíveis e reguláveis
 Porta com abertura de 90° e fechadura com chave
 Capacidade máxima gavetas: 60Kg



TOP EM BORRACHA EXPANDIDA

MADE IN ITALY



PRATELEIRAS INTERIORES AMOVÍVEIS E REGULÁVEIS



CÓDIGO				Gavetas	€/lista	€/PROMO
FG 109V/6G	FG 109B/6G	FG 109R/6G	FG 109D/6G	6	1.600,00€	849,00€
FG 109V/7G	FG 109B/7G	FG 109R/7G	FG 109D/7G	7	1.650,00€	879,00€





A PORTA ABRE A 110°

MADE IN ITALY

NEW FG 162



PUXADOR DE AÇO INOXIDÁVEL



GAVETAS EQUIPADAS COM TAPETE INTERIOR

CARACTERÍSTICAS TÉCNICAS:

Guias telescópicas de fecho automático
Pega lateral de aço inoxidável
Suporte para rolo e porta-latas incluídos
Gavetas equipadas com tapete de borracha interior
Painéis laterais com orifícios para ganchos de ferramentas
Prateleira superior em chapa de 2mm, **com top em policarbonato**
4 rodas de borracha vulcanizada Ø160mm (2 fixas, 2 giratórias com travão)
Portas que abrem a 110°, equipadas com fechadura e 2 prateleiras interiores amovíveis
Grelha porta-ferramentas lateral (530x240mm)
14 gavetas: 5 gavetas 580x398x75mm, 2 gavetas 580x398x135mm, 5 gavetas 580x235x75mm, 2 gavetas 580x235x135mm
Capacidade da gaveta: 45Kg



FG 162V/14P

FG 162B/14P

FG 162R/14P

FG 162D/14P

CARRO PORTA FERRAMENTAS 14 GAVETAS MOD. FG 162

CÓDIGO	RAL	Capacidade kg	N. gavetas	€/Lista	€/PROMO
FG 162V/14P	6018	2400	14	3.300,00	1.799,00
FG 162B/14P	5002	2400	14	3.300,00	1.799,00
FG 162R/14P	3001	2400	14	3.300,00	1.799,00
FG 162D/14P	7021	2400	14	3.300,00	1.799,00

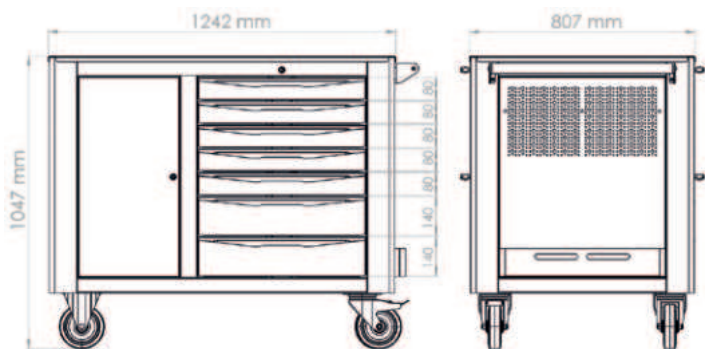

2400 Kg PORTATA STATICA



A PORTA ABRE A 110°



POSSIBILIDADE APLICAR VÁRIOS ACESSÓRIOS



7 GAVETAS TRAZ PEQUENAS PEÇAS



FG 160

CARACTERÍSTICAS TÉCNICAS:

Guias telescópicas de fecho automático
Pega lateral de aço inoxidável
Suporte para rolo e porta-latas incluídos
Gavetas equipadas com tapete de borracha interior
Painéis laterais com orifícios para ganchos de ferramentas
Prateleira superior em chapa de 2mm, **com top em contraplacado de bétula fenólico**
4 rodas de borracha vulcanizada Ø160mm (2 fixas, 2 giratórias com travão)
Portas que abrem a 110°, equipadas com fechadura e 2 prateleiras interiores amovíveis
Grelha porta-ferramentas lateral (530x240mm)
14 gavetas: 5 gavetas 580x398x75mm, 2 gavetas 580x398x135mm, 5 gavetas 580x235x75mm, 2 gavetas 580x235x135mm
Capacidade da gaveta: 45Kg

MADE IN ITALY

CARRO PORTA FERRAMENTAS 14 GAVETAS MOD. FG 160

CÓDIGO	RAL	Capacidade kg	N. gavetas	€/Lista	€/PROMO
FG 160V/14L	6018	2400	14	3.200,00	1.699,00
FG 160B/14L	5002	2400	14	3.200,00	1.699,00
FG 160R/14L	3001	2400	14	3.200,00	1.699,00
FG 160D/14L	7021	2400	14	3.200,00	1.699,00

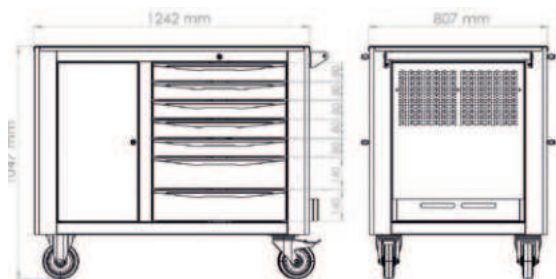

FG 160V/14L

FG 160B/14L

FG 160R/14L

FG 160D/14L



FG 150

CARRO DE FERRAMENTAS MODELO FG 150

Corrediças telescópicas com sistema de acoplamento automático
 4 rodas de borracha vulcanizada Ø125mm (2 fixas, 2 giratórias)
 Pega lateral em aço
 Sistema de fecho centralizado
 Gavetas equipadas com tapete de borracha interior
 Top em espuma de borracha
 3 gavetas 580x398x54mm, 1 gaveta 580x398x110mm e 1 gaveta 580x398x200mm
 Capacidade das gavetas: 30Kg

800 Kg **PORTATA STATICA**



TOP DE BORRACHA

MADE IN ITALY



PEGA DE AÇO

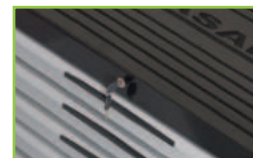

FECHO CENTRALIZADO



CÓDIGO	Gavetas	€/lista	€/PROMO
FG 150D/5G	FG 150R/5G	5	1.100,00€ 589,00€
FG 150D/6G	FG 150R/6G	6	1.150,00€ 629,00€
FG 150D/7G	FG 150R/7G	7	1.200,00€ 659,00€

FG 101

CARRO DE FERRAMENTAS MODELO FG 101

Corrediças telescópicas com sistema de acoplamento automático
 4 rodas de borracha vulcanizada Ø125mm (2 fixas, 1 giratória e 1 giratória com travão)
 Pega lateral em aço pintado
 Sistema de fecho centralizado
 Sistema de abertura por baioneta
 Gavetas com tapete de borracha interior
 Tampo em borracha macia
 Cor fixa em dark
 Capacidade das gavetas: 35kg

500 Kg **PORTATA STATICA**



SISTEMA DE ABERTURA DE BAIONETA



PEGA EM AÇO



CÓDIGO	Gavetas	€/lista	€/PROMO
FG 101D/5G	5	680,00€	359,00€
FG 101D/6G	6	710,00€	379,00€
FG 101D/7G	7	750,00€	399,00€

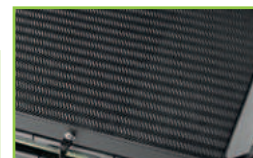

TOP DE BORRACHA



FG 101V/3G

~~500,00€~~

249,00€

CARRO COM 3 GAVETAS MODELO FG 101



Possibilidade de inserção de módulos de ferramentas



2 prateleiras (porta objectos superior e inferior 680x440 mm)

FG 94/MI

~~52,00€~~

24,90€

PORTA FERRAMENTAS MAGNÉTICO

Dimensões 120x94x400 mm



Fixação magnética

FG 94/MS

~~34,00€~~

18,90€

PORTA FERRAMENTAS MAGNÉTICO

PVC resistente a riscos



Fixação magnética

FG 108/B

~~150,00€~~

89,00€

CARRINHO MULTI SERVIÇO UNIVERSAL PARA PEÇAS PEQUENAS E FERRAMENTAS DE TRABALHO



Equipado com 16 tabuleiros amovíveis para peças pequenas



Estrutura lateral em alumínio e prateleiras e acessórios em ABS

FG 94/R

~~20,00€~~

11,90€

PORTA FERRAMENTAS MAGNÉTICO

Dimensões 165x245 mm



Fixação magnética

FG 94/T

~~17,00€~~

9,90€

PORTA FERRAMENTAS MAGNÉTICO

Ø 150 mm



Fixação magnética



FG 101D/AS165

1.684,00€

699,00€

CARRO DE FERRAMENTAS COM 6 GAVETAS, MODELO FG 101, COM UM SORTIDO DE 165 FERRAMENTAS EM MÓDULOS RÍGIDOS



SORTIDO 165 FERRAMENTAS

1º GAVETA



- FG 102/03G: Módulo rígido 14 llaves boca/ lunetas poligonales
- FG 102/17E: Módulo 65 herramientas de 1/4"
- FG 102/21E: Módulo chaves de caixas 6PT

2º GAVETA



- FG 102/48G: Módulo rígido 52 puntas de 10mm
- FG 102/VA1: Módulo rígido porta-objectos
- FG 102/65B: Módulo rígido 2 alicates ajustavel

3º GAVETA



- FG 102/45D: Módulo rígido 6 chaves de fenda sl e ph
- FG 102/45I: Módulo rígido 6 chaves de fenda torx
- FG 102/39D: Módulo rígido 3 alicates



SISTEMA DE ABERTURA DE BAIONETA

FG 101D/AS196

~~2.133,00€~~

799,00€

CARRO DE FERRAMENTAS COM 7 GAVETAS, MODELO FG 101, COM UM SORTIDO DE 196 FERRAMENTAS EM MÓDULOS RÍGIDOS



SORTIDO 196 FERRAMENTAS

1° GAVETA



- FG 102/03G: Módulo rígido 14 llaves boca/ lunetas poligonales
- FG 102/17E: Módulo 65 herramientas de 1/4"
- FG 102/21B: Módulo de chave hexagonal 1/2" 8-32mm + acessórios

2° GAVETA



- FG 102/39D: Módulo rígido 3 alicates
- FG 102/45I: Módulo rígido 6 chaves Torx
- FG 102/45D: Módulo rígido 6 chaves de fenda sl e ph

3° GAVETA



- FG 102/48G: Módulo rígido 52 pontas de 10mm
- FG 102/60D: Módulo de ferramenta de manutenção
- FG 102/23C: Módulo rígido chaves de caixas reforçadas

4° GAVETA



- FG 618/A8, A10, A13, A17, A19: Chaves T hexagonais com juntas





FG 102V/AS205

2.558,00€

999,00€

CARRO DE FERRAMENTAS COM 6 GAVETAS, MODELO FG 102, COM UM SORTIDO DE 205 FERRAMENTAS EM MÓDULOS RÍGIDOS



CÓDIGO

FG 102V/AS205

FG 102B/AS205

FG 102R/AS205

FG 102D/AS205

SORTIDO 205 FERRAMENTAS



1º GAVETA



- FG 102/03G: Módulo rígido 14 llaves boca/ lunetas poligonales
- FG 102/17: Módulo 18 ferramentas de 1/4"
- FG 102/21B: Módulo de chave de caixa 1/2" 8-32mm + acessórios

2º GAVETA



- FG 102/21TX: Módulo rígido 44 ferramentas torx
- FG 102/21H: Módulo rígido chaves de ponta 1/2" hexagonais e xzn
- FG 102/39D: Módulo rígido 3 alicates

3º GAVETA



- FG 102/45F: Módulo rígido 6 chaves de fenda ph
- FG 102/45G: Módulo rígido 7 llaves de fenda sl
- FG 102/48G: Módulo rígido 52 pontas de 10mm

4º GAVETA

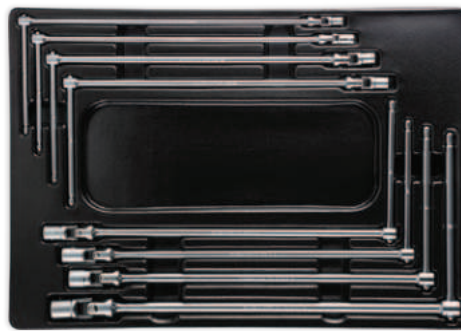

- FG 102/10C: Módulo de 8 chaves T de junta hexagonal 7-19mm

TOP DE BORRACHA



FG 122V/AS168

~~2.655,00€~~ **1.199,00€**

CARRO DE FERRAMENTAS COM 7 GAVETAS, MODELO FG 122, COM UM SORTIDO DE 168 FERRAMENTAS EM MÓDULOS RÍGIDOS



CÓDIGO

FG 122V/AS168	FG 122D/AS168	FG 122B/AS168	FG 122R/AS168
---------------	---------------	---------------	---------------

SORTIDO 168 FERRAMENTAS



1º GAVETA



- FG 102/03G: Módulo rígido 14 llaves boca/ lunetas poligonales
- FG 102/21B: Módulo de chave de caixa 1/2" 8-32mm + acessórios
- FG 102/17E: Módulo 65 ferramentas de 1/4"

2º GAVETA



- FG 102/42C: Módulo rígido 4 alicates de freios
- FG 102/21H: Módulo rígido chaves de ponta 1/2" hexagonais e xzn
- FG 102/39XT: Módulo 3 alicates

3º GAVETA



- FG 102/45F: Módulo rígido 6 chaves de fenda ph
- FG 102/45G: Módulo rígido 7 llaves de fenda sl
- FG 102/45I: Módulo rígido 6 chaves Torx

4º GAVETA



- FG 102/56C: Módulo rígido ferramentas de percussão
- FG 102/60D: Módulo de ferramenta de manutenção
- FG 102/65B: Módulo rígido 2 alicates ajustavel

4 RODAS DE BORRACHA VULCANIZADO Ø125mm (2 FIXOS E 2 GIRATÓRIOS 1 COM TRAVÃO)





FG 100V/AS212

2.751,00€ 1.199,00€

CARRO DE FERRAMENTAS COM 7 GAVETAS, MODELO FG 100, COM UM SORTIDO DE 212 FERRAMENTAS EM MÓDULOS RÍGIDOS



CÓDIGO

FG 100V/AS212	FG 100B/AS212	FG 100R/AS212	FG 100D/AS212	FG 100W/AS212
---------------	---------------	---------------	---------------	---------------

SORTIDO 212 FERRAMENTAS

1º GAVETA



- FG 102/03G: Módulo rígido 14 llaves boca/ lunetas poligonales
- FG 102/03L: Módulo 6 chaves de bocas
- FG 102/21B: Módulo de chave de caixa 1/2" 8-32mm + acessórios

2º GAVETA



- FG 102/17E: Módulo 65 ferramentas de 1/4"
- FG 102/19: Módulo 18 ferramentas 3/8"
- FG 102/45I: Módulo rígido 6 chaves Torx

3º GAVETA



- FG 102/39XT: Módulo 3 alicates
- FG 102/42C: Módulo rígido 4 alicates de freios
- FG 102/45E: Módulo rígido 8 chaves de fenda sl e ph

4º GAVETA



- FG 102/56C: Módulo rígido ferramentas de percussão
- FG 102/65B: Módulo rígido 2 alicates ajustavel
- FG 102/48G: Módulo rígido 52 pontas de 10mm



NOVO PUNHO DE AÇO INTEGRADO



FG 100V/AS183

~~2.685,00€~~ **1.199,00€**

CARRO DE FERRAMENTAS COM 7 GAVETAS, MODELO FG 100, COM UM SORTIDO DE 183 FERRAMENTAS EM MÓDULOS RÍGIDOS



CÓDIGO

FG 100V/AS183	FG 100B/AS183	FG 100R/AS183	FG 100D/AS183	FG 100W/AS183
---------------	---------------	---------------	---------------	---------------

SORTIDO 183 FERRAMENTAS

1º GAVETA



- FG 102/03G: Módulo rígido 14 llaves boca/ lunetas poligonales
- FG 102/03L: Módulo 6 chaves de bocas
- FG 102/21B: Módulo de chave de caixa 1/2" 8-32mm + acessórios

2º GAVETA



- FG 102/17: Módulo 18 ferramentas de 1/4"
- FG 102/48G: Módulo rígido 52 pontas de 10mm
- FG 102/21TX: Módulo rígido 44 ferramentas Torx

3º GAVETA



- FG 102/39XT: Módulo 3 alicates
- FG 102/45D: Módulo rígido 6 chaves de fenda sl e ph
- FG 102/45I: Módulo rígido 6 chaves Torx

4º GAVETA



- FG 102/10C: Módulo de 8 chaves T de junta hexagonal 7-19mm

**GAVETA
COM ABERTURA
TOTAL**





FG 100V/AS371

3.785,80€ 1.399,00€

CARRO DE FERRAMENTAS COM 7 GAVETAS, MODELO FG 100, COM UM SORTIDO DE 371 FERRAMENTAS EM MÓDULOS RÍGIDOS



CÓDIGO

FG 100V/AS371	FG 100B/AS371	FG 100R/AS371	FG 100D/AS371	FG 100W/AS371
---------------	---------------	---------------	---------------	---------------

SORTIDO 371 FERRAMENTAS

1° GAVETA



- FG 102/03G: Módulo rígido 14 llaves boca/ lunetas poligonales
- FG 102/03L: Módulo 6 chaves de bocas
- FG 102/03E: Módulo rígido 8 chaves de boca

2° GAVETA



- FG 102/17E: Módulo 65 herramientas de 1/4"
- FG 102/19: Módulo 18 ferramentas 3/8"
- FG 102/21B: Módulo de chave de caixa 1/2" 8-32mm + acessórios

3° GAVETA



- FG 102/21TX: Módulo rígido 44 ferramentas Torx
- FG 102/21H: Módulo rígido chaves de ponta 1/2" hexagonais e xzn
- FG 102/21R: Módulo chaves de pontas ribe

4° GAVETA



- FG 102/56C: Módulo rígido ferramentas de percussão
- FG 102/39XT: Módulo 3 alicates
- FG 102/42C: Módulo rígido 4 alicates de freios

5° GAVETA



- FG 102/45G: Módulo rígido 7 chaves de fenda ph
- FG 102/45F: Módulo rígido 6 chaves de fenda ph
- FG 102/45I: Módulo rígido 6 chaves Torx

6° GAVETA



- FG 102/48G: Módulo rígido 52 pontas de 10mm
- FG 102/65B: Módulo rígido 2 alicates ajustavel
- FG 102/23C: Módulo rígido chaves de caixas reforçadas
- FG 85/S31: Jogo de bits de 1/4" + adaptador de suporte de bits de 1/4" x 1/4"



FG 124V/AS231

~~3.539,00€~~

1.499,00€

CARRO DE FERRAMENTAS COM 7 GAVETAS, MODELO FG 124, COM UM SORTIDO DE 231 FERRAMENTAS EM MÓDULOS RÍGIDOS



CÓDIGO

FG 124V/AS231	FG 124D/AS231	FG 124B/AS231	FG 124R/AS231
---------------	---------------	---------------	---------------

SORTIDO 231 FERRAMENTAS

1º GAVETA



- FG 102/03H: Módulo 18 chaves boca/lunetas poligonais
- FG 102/03E: Módulo rígido 8 chaves de boca
- FG 102/07C: Módulo 7 chaves de luneta com curvatura

2º GAVETA



- FG 102/17E: Módulo 65 ferramentas de 1/4"
- FG 102/21TX: Módulo rígido 44 ferramentas Torx
- FG 102/21B: Módulo de chave de caixa 1/2" 8-32mm + acessórios
- FG 102/21H: Módulo rígido chaves de ponta 1/2" hexagonais e xzn

3º GAVETA



- FG 102/42C: Módulo rígido 4 alicates de freios
- FG 102/39XT: Módulo 3 alicates
- FG 102/45D: Módulo rígido 6 chaves de fenda sl e ph
- FG 102/45I: Módulo rígido 6 chaves Torx

4º GAVETA



- FG 102/65B: Módulo rígido 2 alicates ajustavel
- FG 102/10C: Módulo de 8 chaves T de junta hexagonal 7-19mm

NOVO DESIGN DA ALÇA





FG 102/03G

140,00€

85,00€

MÓDULO 14 CHAVES BOCA/LUNETAS MM
FG 600/B6,7,8,9,10,11,12,13, 14,15,16,17,18,19mm



1/3

FG 102/07C

98,00€

59,90€

MÓDULO 7 CHAVES DE LUNETA CURVADAS
FG 615/B6x7, 8x9, 10x11,12x13, 14x15, 16x17, 18x19mm



1/3

FG 102/03L

145,00€

89,00€

MÓDULO 6 CHAVES BOCA/LUNETAS MM
FG 600/B21, 22, 24, 27, 30, 32 mm



1/3

FG 102/07D

138,00€

82,90€

MÓDULO 5 CHAVES DE LUNETA CURVADAS
FG 615/B20x22, 21x23, 24x27, 25x28, 30x32mm



1/3

FG 102/03H

250,00€

149,00€

MÓDULO 18 CHAVES BOCA/LUNETAS MM
FG 600/B6,7,8,10,11,12,13,14,16,17,18,19, 21, 22, 24, 27, 30, 32mm



2/3

FG 102/08C

245,00€

149,00€

MÓDULO 11 CHAVES COM ROQUETE
FG 605/B8, 10, 11, 12, 13, 14, 15, 16, 17, 18, 19mm



1/3

FG 102/03E

85,00€

51,90€

MÓDULO 8 CHAVES DE BOCAS
FG 602/B6x7, 8x9, 10x11, 12x13, 14x15, 16x17, 18x19, 20x22 mm + FG 139C/FS



1/3

FG 102/10C

340,00€

209,00€

MÓDULO 8 CHAVES EM T HEXAGONAIS
FG 618/A7, 8, 10, 11, 13, 14, 17, 19 mm



1/1

FG 102/03F

100,00€

63,90€

MÓDULO 5 CHAVES DE BOCAS
FG 602/B21x23, 24x26, 25x28, 27x29, 30x32 mm



1/3

FG 102/13C

190,00€

119,00€

MÓDULO 8 CHAVES DE CACHIMBO
FG 613/A6,7,8,10,11,12,13,14,17,19mm

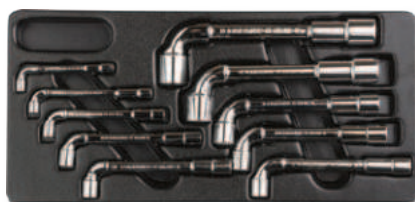

1/3

FG 102/17

135,00€

79,90€

MÓDULO CHAVES DE CAIXAS 6PT

FG 615/B6x7, 8x9, 10x11,12x13, 14x15, 16x17, 18x19mm



1/3



MÓDULO CHAVES DE CAIXAS 6PT

10-23mm



1/3



CÓDIGO	ATAQUE	€/LISTA	€/PROMO
FG 102/21E	Sextavado	170,00€	99,00€
FG 102/21D	Poligonal	170,00€	99,00€

FG 102/17E

275,00€

159,00€

MÓDULO CHAVES DE CAIXAS 6PT

FG 605/B8, 10, 11, 12, 13, 14, 15, 16, 17, 18, 19mm



1/3



FG 102/21TX

245,00€

139,00€

MÓDULO FERRAMENTAS TORX



1/3



FG 102/19

200,00€

119,00€

MÓDULO CHAVES DE CAIXAS 6PT

8-23 Hexagonal

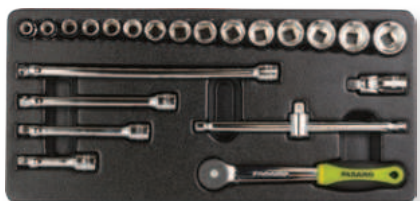

1/3



FG 102/21H

210,00€

129,00€

MÓDULO CHAVES DE PONTAS

FG 150/H2-H8, FG 150L/H2-H8, FG 150/M5-M16, FG 1

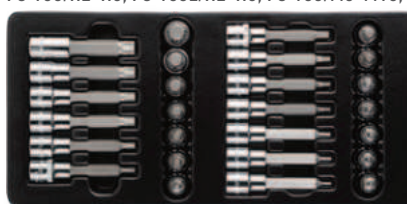

1/3



FG 102/19B

200,00€

119,00€

MÓDULO CHAVES DE CAIXAS 6PT

8- 23mm Poligonal



1/3



FG 102/21R

230,00€

139,00€

MÓDULO CHAVES DE PONTAS RIBE

FG 150/R4-R14, FG 150L/R4-R14, FG 150/R4-R14, FG 150L/R4-R14



1/3



MÓDULO CHAVES DE CAIXAS 6PT

10-23mm



1/3



MÓDULO CHAVES DE CAIXAS 6PT

34-50mm



1/2



CÓDIGO	ATAQUE	€/LISTA	€/PROMO
FG 102/21B	Sextavado	245,00€	139,00€
FG 102/21C	Poligonal	255,00€	139,00€

CÓDIGO	ATAQUE	€/LISTA	€/PROMO
FG 102/25	Sextavado	395,00€	239,00€
FG 102/25B	Poligonal	395,00€	239,00€



FG 102/23C

~~145,50€~~

89,00€

MÓDULO CHAVES DE CAIXAS DE IMPACTO

FG 628/C10,11,12,13,14,16,17,18,19,21,22,23,24mm + FG 628/PR125



1/3

1/2"

FG 102/51H

~~130,00€~~

79,90€

MÓDULO DE 7 TECLAS HEXAGONAL

FG 621/H2, 2.5, 3, 4, 5, 6, 8mm



1/3



FG 102/39XT

~~102,00€~~

59,90€

MÓDULO 3 ALICATES

FG 59/XT180 - FG 61/XT160 - FG 63XT160



1/3

FG 102/39D

~~75,00€~~

45,90€

MÓDULO 3 ALICATES

FG 59PV/180, FG 61PV/160, FG 63PV/160



1/3

MÓDULO 4 ALICATES DE FREIOS



1/3

CÓDIGO	CAPACIDADE	€/LISTA	€/PROMO
FG 102/41C	8-25mm	98,00€	57,90€
FG 102/42C	19-60mm	110,00€	59,90€

FG 102/45D

~~47,00€~~

27,90€

MÓDULO DE 6 CHAVES DE FENDA

FG 22/3x100, 4x125, 5.5x150, 6.5x150,
FG 22/PH1x80, PH2x150



1/3



FG 102/45E

~~57,00€~~

33,90€

MÓDULO DE 8 CHAVES DE FENDA

3x100, 4x125, 5.5x150, 6.5x150, 6.5x38,
PH1x80, PH2x150, PH2x38



1/3



FG 102/45F

~~54,00€~~

32,90€

MÓDULO DE 6 CHAVES DE FENDA

PH0x60, PH1x150, PH2x100, PH2x150, PH3x150, PH2x38



1/3



FG 102/45G

~~54,00€~~

32,90€

MÓDULO DE 7 CHAVES DE FENDA

2.5x60, 3x100, 3.5x100, 4x125, 5.5x150, 5.5x100, 6.5x150



1/3



FG 102/45U

~~98,00€~~

59,90€

MÓDULO DE 12 CHAVES DE FENDA



2/3



MÓDULO DE 6 CHAVES DE FENDA

TX10, TX15, TX20, TX25, TX27, TX30



1/3  

CÓDIGO	ATTACCO	€/LISTINO	€/PROMO
FG 102/45I	Torx	66,00€	39,90€
FG 102/45L	Torx forato	67,00€	40,90€

FG 102/45T

~~78,00€~~

39,90€

MÓDULO DE 6 CHAVES DE FENDA

FG 22/FX6,FX7,FX8,FX10,FX13



1/3 

FG 102/48G

~~120,00€~~

72,90€

MÓDULO DE PONTAS DE 10MM



1/3  

FG 102/50F

~~76,00€~~

45,90€

MÓDULO DE CHAVES MACHOS HEXAGONAIS

FG 142/2, 2.5, 3, 4, 5, 6



1/3 

FG 102/50G

~~76,00€~~

45,90€

MÓDULO DE CHAVES MACHOS TORX

FG 143/TX10, TX15, TX20, TX25, TX27, TX30



1/3 

FG 102/56C

~~125,00€~~

79,90€

MÓDULO FERRAMENTAS DE PERCUSSÃO

FG 132/500, FG 136/40, FG 126/SN1, FG 126/SN3



1/3 

FG 102/60D

~~58,00€~~

36,90€

MÓDULO DE FERRAMENTA DE MANUTENÇÃO

FG 44/MT5, FG 50/AR, FG 48/LG, FG 79/SP4, FG 497/OP1



1/3 

FG 102/62B

~~95,00€~~

59,90€

MÓDULO 5 LIMAS MEIO-MURÇAS

FG 80/8AR, FG 80/8AM, FG 80/8AP, FG 80/8AT, FG 80/8AQ



1/3 

FG 102/65B

~~66,00€~~

41,90€

MÓDULO 2 ALICATES

FG 80/8AR, FG 80/8AM, FG 80/8AP, FG 80/8AT, FG 80/8AQ
FG 58/B240, FG 69/CJ250



1/3 

FG 102/VA1

~~15,00€~~

8,90€

MÓDULO PORTA OBJECTOS



1/3 



FG 122V/AS217

2.594,50€

1.099,00€

CARRO DE FERRAMENTAS FG 122 DE 6 GAVETAS COM 217 FERRAMENTAS EM MÓDULOS DE BORRACHA



CÓDIGO

FG 122V/AS217	FG 122D/AS217	FG 122B/AS217	FG 122R/AS217
---------------	---------------	---------------	---------------

SORTIDO 217 FERRAMENTAS



1º GAVETA

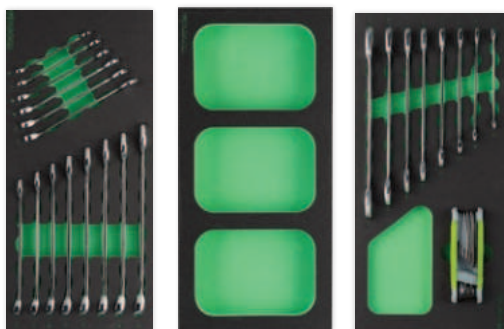

- FG 100/03G: Módulo rígido 14 laves boca/ lunetas poligonales
- FG 100/VA1: Módulo rígido porta-objectos
- FG 100/03E: Módulo 8 chaves de bocas + jogo de 9 chaves sextavadas

2º GAVETA

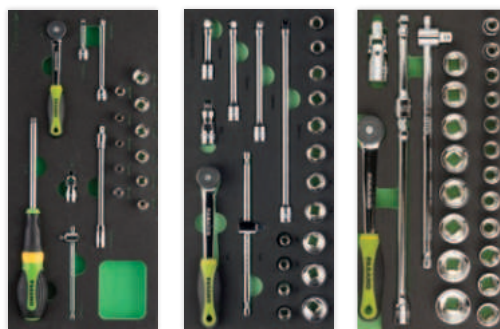

- FG 100/17: Módulo 18 ferramentas de 1/4"
- FG 100/19: Módulo chaves de caixas 6PT
- FG 100/21B: Módulo de chave de caixa 1/2" 8-32mm + acessórios

3º GAVETA



- FG 100/39XT: Módulo 3 alicates
- FG 100/48E: Módulo 98 inserções de 1/4" + 2 suportes de inserção e espaço vazio
- FG 100/65B: Módulo de alicates

4º GAVETA



- FG 100/45F: Módulo 6 chaves de fenda PH
- FG 100/45G: Módulo de 7 chaves de fenda
- FG 100/56C: Módulo de percussão

TOP SUPERIOR EM BORRACHA COM ACABAMENTO EM CARBONO 3D



FG 100V/AS224

~~2.878,00€~~ **1.199,00€**

CARRO DE FERRAMENTAS FG 100 DE 7 GAVETAS COM 224 FERRAMENTAS EM MÓDULOS DE BORRACHA



CÓDIGO

FG 100V/AS224	FG 100B/AS224	FG 100R/AS224	FG 100D/AS224	FG 100W/AS224
---------------	---------------	---------------	---------------	---------------

SORTIDO 224 FERRAMENTAS

1º GAVETA



- FG 100/03G: Módulo rígido 14 llaves boca/ lunetas poligonales
- FG 100/17E: Módulo 65 herramientas de 1/4"
- FG 100/21B: Módulo de chave de caixa 1/2" 8-32mm + acessórios

2º GAVETA

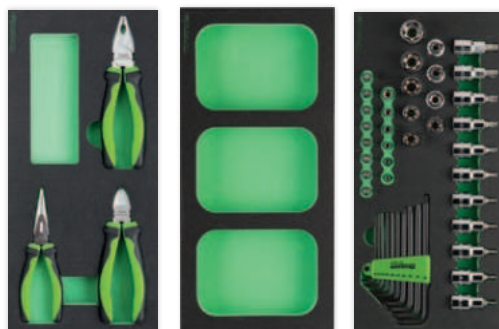

- FG 100/39XT: Módulo 3 alicates
- FG 100/VA1: Módulo rígido porta-objectos
- FG 100/21TX: Módulo rígido 44 ferramentas torx

3º GAVETA



- FG 100/45I: Módulo 6 chaves de fenda Torx
- FG 100/45D: Módulo 6 chaves de fenda SL e PH
- FG 100/48G: Módulo 52 puntas de 10mm

4º GAVETA

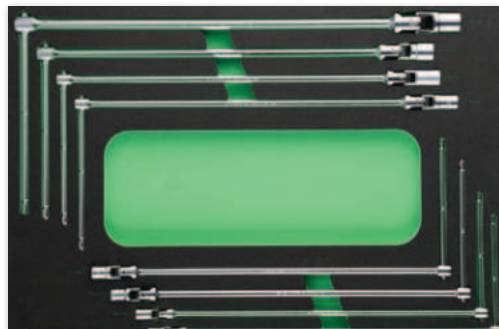

- FG 100/10C: Módulo 8 chaves em T hexagonais 7-19mm

PRATELEIRA SUPERIOR EM ABS





FG 122V/AS283

3.567,00€

1.349,00€

CARRO DE FERRAMENTAS FG 122 DE 7 GAVETAS COM 283 FERRAMENTAS EM MÓDULOS DE BORRACHA



CÓDIGO

FG 122V/AS283

FG 122D/AS283

FG 122B/AS283

FG 122R/AS283

SORTIDO 283 FERRAMENTAS



1º GAVETA

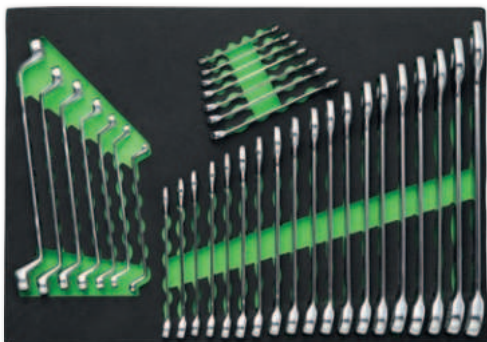

FG 100/03M: Módulo de chaves combinadas poligonais e dupla curvatura

2º GAVETA



-FG 100/21F: Módulo 1/4", 1/2", 3/8" chaves de caixa hexagonais e acessórios

3º GAVETA



-FG 100/39F: Módulo chaves para parafusos, alicates, y pontas

4º GAVETA

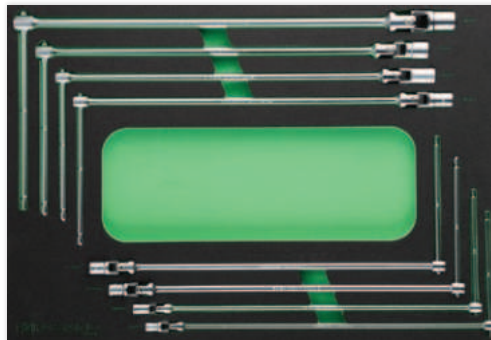

- FG 100/10C: Módulo 8 chaves em T hexagonais 7-19mm

MÓDULOS DE BORRACHA COM GAVETA COMPLETA



FG 100V/AS413

~~4.812,80€~~ **1.399,00€**

FG 100 CARRO DE FERRAMENTAS DE 7 GAVETAS COM 413 FERRAMENTAS EM MÓDULOS DE BORRACHA



CÓDIGO

FG 100V/AS413	FG 100B/AS413	FG 100R/AS413	FG 100D/AS413	FG 100W/AS413
---------------	---------------	---------------	---------------	---------------

SORTIDO 413 FERRAMENTAS



1° GAVETA

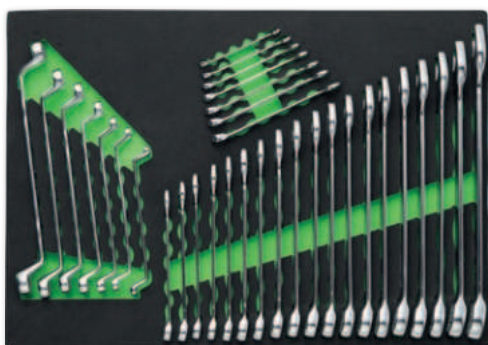

-FG 100/03M: Módulo de chaves combinadas poligonais e dupla curvatura

2° GAVETA



-FG 100/21F: Módulo 1/4", 1/2", 3/8" chaves de caixa hexagonais e acessórios

3° GAVETA



-FG 100/81G: Módulo chaves de ponta 1/4" e 1/2"

4° GAVETA

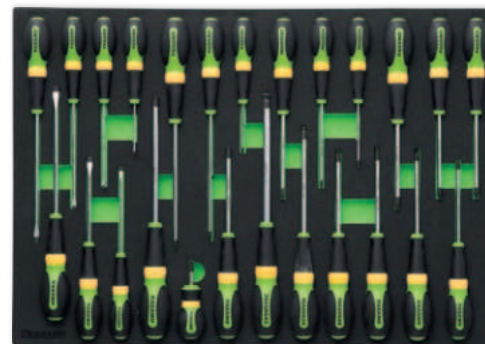

-FG 100/45R: Módulo chaves parafusos de fenda, ph, hex, esféricas y torx

5° GAVETA



-FG 100/39E: Módulo de alicates e pontas





CARROS E BANCOS

FG 100V/AS230

3.571,50€

1.399,00€

FG 100 CARRO DE FERRAMENTAS DE 7 GAVETAS
COM 230 FERRAMENTAS EM MÓDULOS DE BORRACHA



CÓDIGO

FG 100V/AS230	FG 100B/AS230	FG 100R/AS230	FG 100D/AS230	FG 100W/AS230
---------------	---------------	---------------	---------------	---------------

SORTIDO 230 FERRAMENTAS

1º GAVETA



- FG 100/03G: Módulo rígido 14 llaves boca/ lunetas poligonales
- FG 100/03L: Módulo 6 chaves boca/lunetas mm
- FG 100/03E: Módulo 8 chaves de bocas + jogo de 9 chaves sextavadas

2º GAVETA

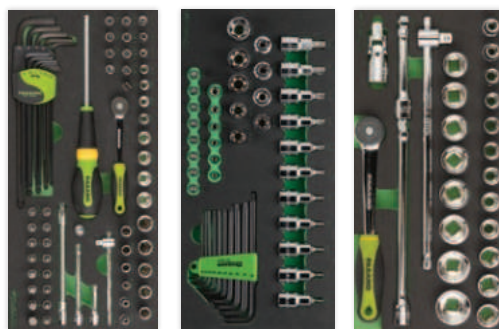

- FG 100/17E: Módulo 65 herramientas de 1/4"
- FG 100/21TX: Módulo rígido 44 ferramentas torx
- FG 100/21B: Módulo de chave de caixa 1/2" 8-32mm + acessórios

3º GAVETA



- FG 100/81F: Módulo de inserção sextavado e XZN 1/2"
- FG 100/65B: Módulo de alicates
- FG 100/42C: Módulo 4 alicates de freios

4º GAVETA



- FG 100/39XT: Módulo 3 alicates
- FG 100/45D: Módulo 6 chaves de fenda SL e PH
- FG 100/45I: Módulo 6 chaves de fenda Torx

5º GAVETA



- FG 100/10D: Módulo 12 chaves em t hexagonais 7-19mm



FASANO
TOOLS

FG 122V/AS402

~~4.933,40€~~ **1.499,00€**

**CARRO DE FERRAMENTAS FG 122 DE 7 GAVETAS
COM 402 FERRAMENTAS EM MÓDULOS DE BORRACHA**



CÓDIGO

FG 122V/AS402	FG 122D/AS402	FG 122B/AS402	FG 122R/AS402
---------------	---------------	---------------	---------------

SORTIDO 402 FERRAMENTAS



1º GAVETA

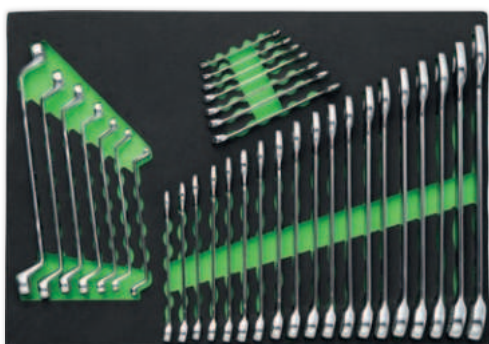

FG 100/03M: Módulo de chaves combinadas poligonais e dupla curvatura

2º GAVETA



-FG 100/21F: Módulo 1/4", 1/2", 3/8" chaves de caixa hexagonais e acessórios

3º GAVETA



-FG 100/81G: Módulo chaves de ponta 1/4" e 1/2"

4º GAVETA



-FG 100/39F: Módulo chaves para parafusos, alicates, y puntas

5º GAVETA

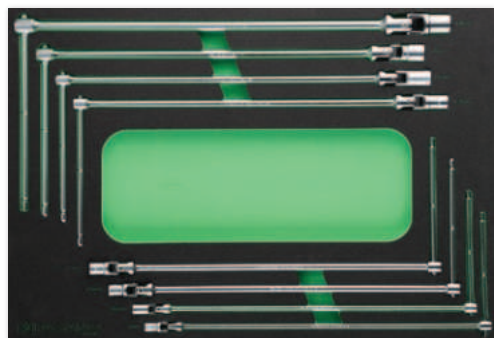

- FG 100/10C: Módulo 8 chaves em T hexagonais 7-19mm





FG 100V/AS382

3.824,00€

1.499,00€

FG 100 CARRO DE FERRAMENTAS DE 7 GAVETAS COM 382 FERRAMENTAS EM MÓDULOS DE BORRACHA



CÓDIGO

FG 100V/AS382	FG 100B/AS382	FG 100R/AS382	FG 100D/AS382	FG 100W/AS382
---------------	---------------	---------------	---------------	---------------

SORTIDO 382 FERRAMENTAS

1° GAVETA



- FG 100/03G: Módulo rígido 14 llaves boca/ lunetas poligonales
- FG 100/03L: Módulo 6 chaves boca/lunetas mm
- FG 100/03E: Módulo 8 chaves de bocas + jogo de 9 chaves sextavadas

2° GAVETA

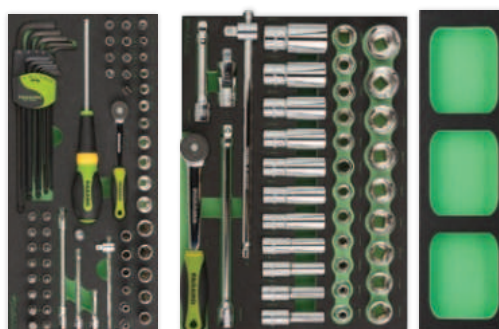

- FG 100/17E: Módulo 65 herramientas de 1/4"
- FG 100/21H: Módulo chaves de caixas 6PT
- FG 100/VA4: Módulo porta objetos

3° GAVETA



- FG 100/21TX: Módulo rígido 44 ferramentas torx
- FG 100/81F: Módulo de inserção sextavado e XZN 1/2"
- FG 100/82B: Módulo chaves de pontas RIBE

4° GAVETA



- FG 100/56C: Módulo de percussão
- FG 100/39XT: Módulo 3 alicates
- FG 100/42C: Módulo 4 alicates de freios

5° GAVETA

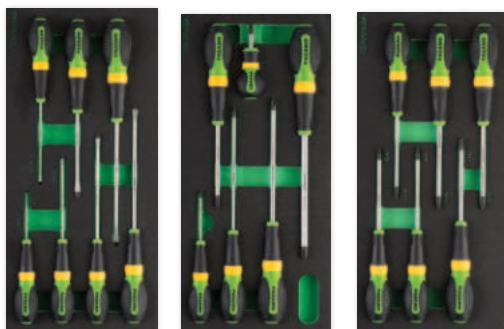

- FG 100/45G: Módulo de 7 chaves de fenda
- FG 100/45F: Módulo 6 chaves de fenda PH
- FG 100/45I: Módulo 6 chaves de fenda Torx

6° GAVETA



- FG 100/48E: Módulo 98 inserções de 1/4" + 2 suportes de inserção e espaço vazio
- FG 100/50E: Módulo de chaves machos hexagonais e Torx



FG 100VD/AS355

~~4.193,80€~~ **1.599,00€**

CARRO DE FERRAMENTAS FG 100 BI COLOR DE 7 GAVETAS COM 355 FERRAMENTAS EM MÓDULOS DE BORRACHA



FG 100VD/AS355 FG 100VW/AS355 FG 100BW/AS355 FG 100RY/AS355 FG 100CW/AS355 FG 100MA/AS355 FG 100RB/AS355
FG 100DP/AS355 FG 100DW/AS355 FG 100BY/AS355 FG 100BD/AS355 FG 100RD/AS355 FG 100GW/AS355 FG 100RW/AS355



SORTIDO 355 FERRAMENTAS

1º GAVETA

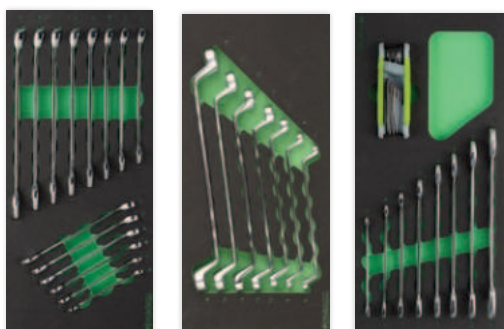

- FG 100/03G: Módulo rígido 14 llaves boca/ lunetas poligonales
- FG 100/07C: Módulo 7 chaves de luneta com curvatura
- FG 100/03E: Módulo 8 chaves de bocas + jogo de 9 chaves sextavadas

2º GAVETA

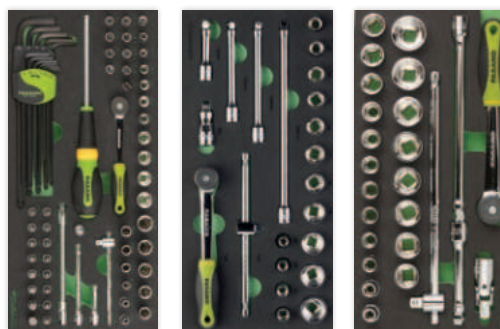

- FG 100/17E: Módulo 65 ferramentas de 1/4"
- FG 100/19: Módulo chaves de caixas 6PT
- FG 100/21B: Módulo de chave de caixa 1/2" 8-32mm + acessórios

3º GAVETA



- FG 100/21TX: Módulo rígido 44 ferramentas torx
- FG 100/81F: Módulo de inserção sextavado e XZN 1/2"
- FG 100/82B: Módulo chaves de pontas RIBE

4º GAVETA

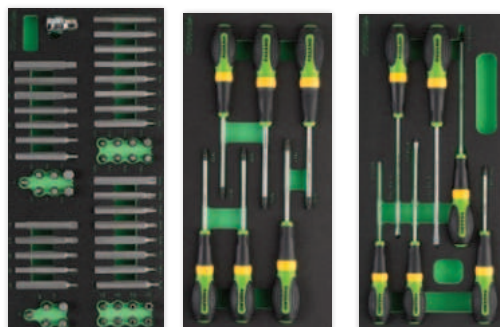

- FG 100/48G: Módulo 52 pontas de 10mm
- FG 100/45I: Módulo 6 chaves de fenda Torx
- FG 100/45D: Módulo 6 chaves de fenda SL e PH

5º GAVETA



- FG 100/65B: Módulo 2 alicates
- FG 100/39XT: Módulo 3 alicates
- FG 100/42C: Módulo 4 alicates de freios

6º GAVETA

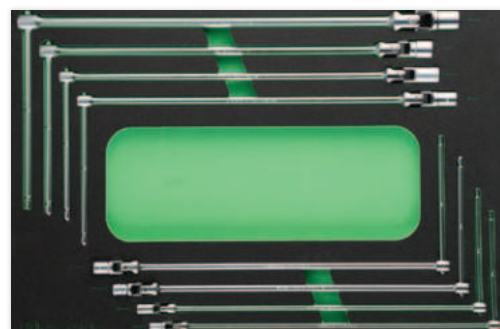

- FG 100/10C: Módulo de 8 chaves T de junta hexagonal 7-19mm
- FG 85/S31: Jogo de bits de 1/4" + adaptador de suporte de bits de 1/4" x 1/4"



FG 124V/AS322

3.926,50€

1.599,00€

CARRO DE FERRAMENTAS FG 124 DE 7 GAVETAS COM 322 FERRAMENTAS EM MÓDULOS DE BORRACHA



CÓDIGO

FG 124V/AS322

FG 124D/AS322

FG 124B/AS322

FG 124R/AS322

SORTIDO 322 FERRAMENTAS



1º GAVETA



- FG 100/03G: Módulo rígido 14 laves boca/ lunetas poligonales
- FG 100/03L: Módulo 6 chaves boca/lunetas mm
- FG 100/VA4: Módulo porta objetos
- FG 100/21H: Módulo chaves de caixas 6PT

2º GAVETA

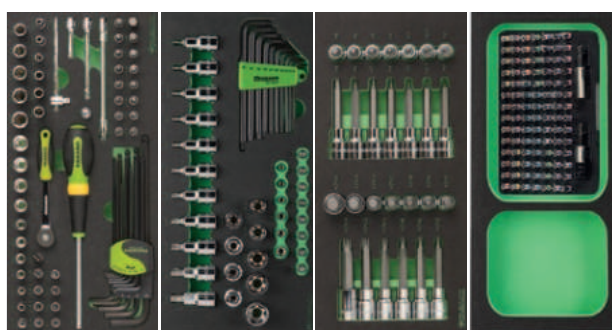

- FG 100/17E: Módulo 65 ferramentas de 1/4"
- FG 100/21TX: Módulo rígido 44 ferramentas torx
- FG 100/81F: Módulo de inserção sextavado e XZN 1/2"
- FG 100/48E: Módulo 98 inserções de 1/4" + 2 suportes de inserção e espaço vazio

3º GAVETA

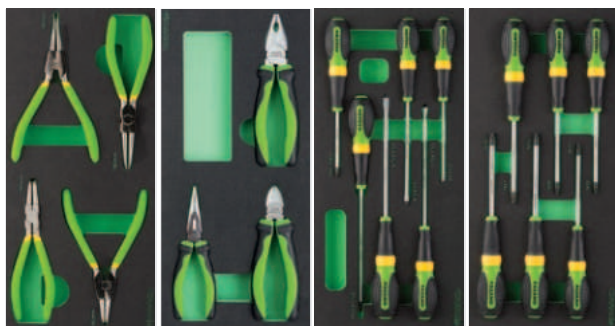

- FG 100/42C: Módulo 4 alicates de freios
- FG 100/39XT: Módulo 3 alicates
- FG 100/45D: Módulo 6 chaves de fenda SL e PH
- FG 100/45I: Módulo 6 chaves de fenda Torx

4º GAVETA

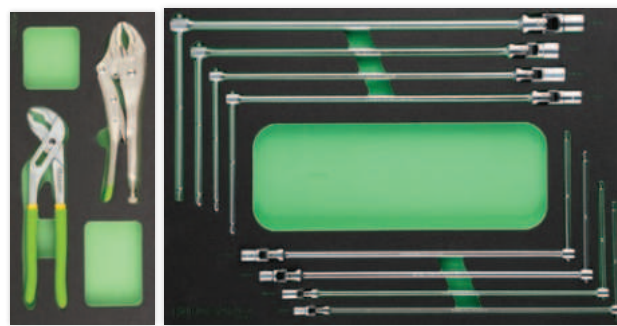

- FG 100/65B: Módulo de alicates
- FG 100/10C: Módulo 8 chaves em T hexagonais 7-19mm

PUXADOR DE AÇO INOXIDÁVEL

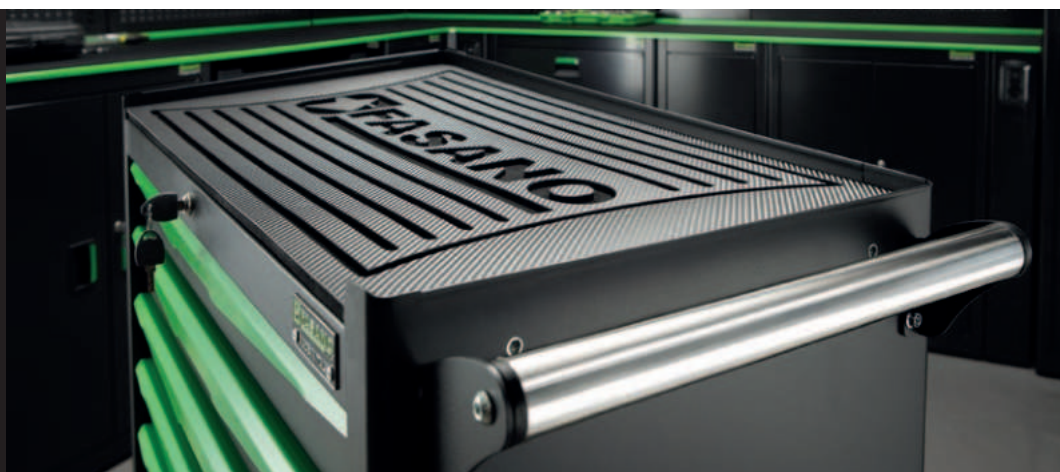

FG 162V/AS288

~~5.942,50€~~ **2.799,00€**

CARRO DE FERRAMENTAS FG 162 DE 14 GAVETAS COM 288 FERRAMENTAS EM MÓDULOS DE BORRACHA



CÓDIGO

FG 162V/AS288	FG 162B/AS288	FG 162R/AS288	FG 162D/AS288
---------------	---------------	---------------	---------------

SORTIDO 288 FERRAMENTAS

1º GAVETA

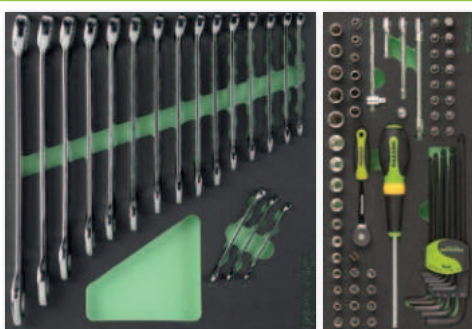

- FG 100/03H: Módulo 18 chaves boca/lunetas mm
- FG 100/17E: Módulo 65 ferramentas de 1/4"

2º GAVETA

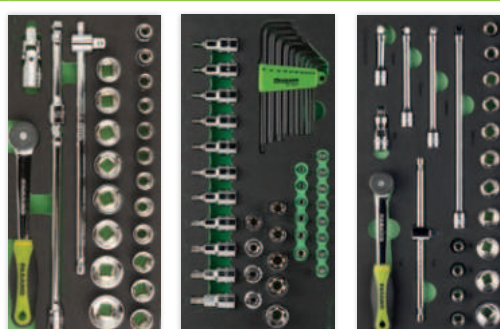

- FG 100/21B: Módulo de chave de caixa 1/2" 8-32mm + acessórios
- FG 100/21TX: Módulo rígido 44 ferramentas torx
- FG 100/19: Módulo chaves de caixas 6PT

3º GAVETA

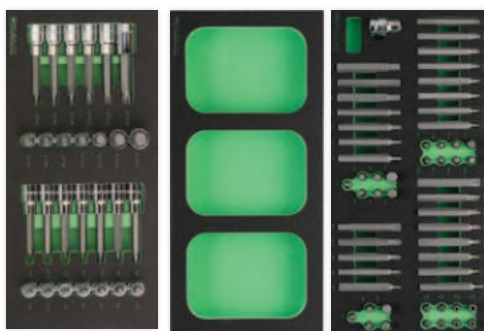

- FG 100/81F: Módulo de inserção sextavado e XZN 1/2"
- FG 100/VA1: Módulo rígido porta-objects
- FG 100/48G: Módulo 52 puntas de 10mm

4º GAVETA

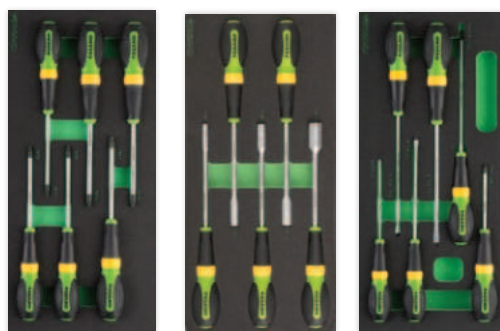

- FG 100/45I: Módulo 6 chaves de fenda Torx
- FG 100/45T: Módulo 5 chaves de fendas sextavadas
- FG 100/45D: Módulo 6 chaves de fenda SL e PH

5º GAVETA



- FG 100/65B: Módulo 3 alicates
- FG 100/39XT: Módulo 3 alicates
- FG 100/42C: Módulo 4 alicates de freios

6º GAVETA

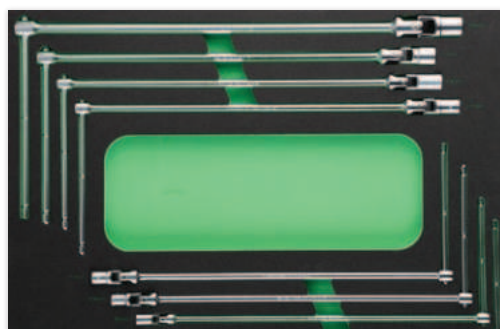

- FG 100/10C: Módulo 8 chaves em T hexagonais 7-19mm



FG 104V/AS284

4.269,00€

1.599,00€

CARRO DE FERRAMENTAS FG 104 DE 7 GAVETAS
COM 284 FERRAMENTAS EM MÓDULOS DE BORRACHA



CÓDIGO

FG 104V/AS284

FG 104B/AS284

FG 104R/AS284

FG 104D/AS284

SORTIDO 284 FERRAMENTAS

1º GAVETA

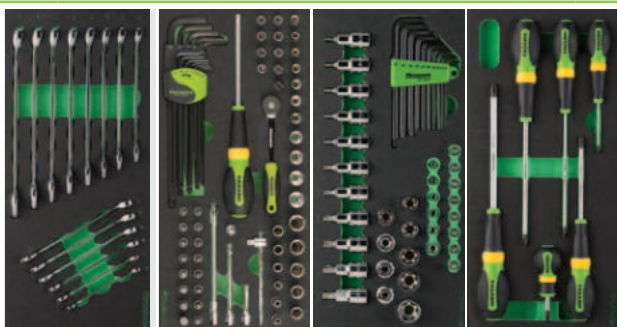

- FG 100/03G: Módulo rígido 14 llaves boca/ lunetas poligonales
- FG 100/17E: Módulo 65 herramientas de 1/4"
- FG 100/21TX: Módulo rígido 44 ferramentas torx
- FG 100/45F: Módulo 6 chaves de fenda Phillips

2º GAVETA



- FG 100/45I: Módulo 6 chaves de fenda Torx
- FG 100/45T: Módulo 5 chaves de fendas sextavadas
- FG 100/56C: Módulo de percussão
- FG 100/81F: Módulo de inserção sextavado e XZN 1/2"

3º GAVETA

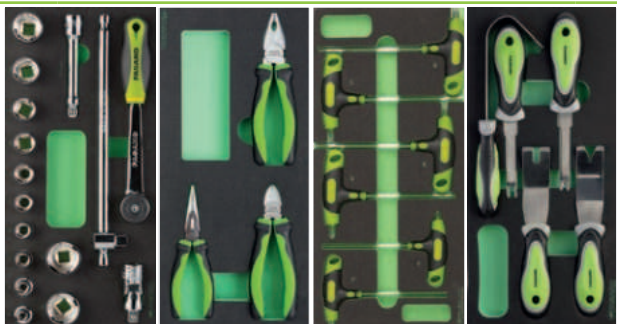

- FG 100/21M: Módulo 16 chaves de caixas 6PT
- FG 100/39XT: Módulo 3 alicates
- FG 100/50G: Módulo de chaves machos Torx
- FG 100/68: Módulo 5 extractores de cavilhas

4º GAVETA



- FG 100/52A: Módulo 8 extractores de cavilhas
- FG 100/52B: Módulo 26 ferramenta de corte para carroçaria
- FG 100/VA4: Módulo porta objetos
- FG 100/52C: Módulo 5 ferramenta para janelas e vidros

5º GAVETA



- FG 100/52D: Módulo 10 raspadores em nylon
- FG 100/52E: Módulo 5 cunhas em plástico
- FG 100/52F: Módulo 5 raspadores em aço
- FG 100/52G: Módulo 5 ferramentas de desmontar

6º GAVETA



- FG 100/52H: Módulo ferramentas para carróçaria
- FG 100/VA1: Módulo porta objetos



FG 102V/AS335

~~4.470,00€~~

1.499,00€

**CARRO DE FERRAMENTAS FG 102 DE 6 GAVETAS
COM 335 FERRAMENTAS EM MÓDULOS DE BORRACHA**



CÓDIGO

FG 102D/AS335	FG 102B/AS335	FG 102R/AS335	FG 102V/AS335
---------------	---------------	---------------	---------------

SORTIDO 335 FERRAMENTAS



1º GAVETA



-FG 100/03M: Módulo de chaves combinadas poligonais e dupla curvatura

2º GAVETA



-FG 100/21F: Módulo 1/4", 1/2", 3/8" chaves de caixa hexagonais e acessórios

3º GAVETA



-FG 100/39F: Módulo chaves para parafusos, alicates, y pontas

4º GAVETA



-FG100/95B: Módulo 41 Ferramentas para pneus

5º GAVETA



-FG100/95C: Módulo 41 ferramentas para pneus





**FERRAMENTAS ESSENCIAIS PARA LIDAR
COM OS NOVOS DESAFIOS DO FUTURO**

THE HYBRID REVOLUTION

26 KIT DE FERRAMENTAS ISOLADAS, COMPLETO COM CAPACETE
DIELÉTRICO E LUVAS DIELÉCTRICAS 1000 V

**IDEAL PARA INTERVENÇÕES EM VEÍCULOS
ELÉCTRICOS E HÍBRIDOS**



CÓDIGO	TAMANHO DA LUVA	€/LISTA	€/PROMO
FG 603/S28A	TAMANHO 9	1.048,50€	539,00€
FG 603/S28B	TAMANHO 10	1.048,50€	539,00€

FG 100V/AS56

~~2.950,70€~~ **1.499,00€**

FG 100 CARRO DE FERRAMENTAS DE 6 GAVETAS COM UM SORTIDO DE 56 FERRAMENTAS ISOLADAS EM MÓDULOS DE BORRACHA



CÓDIGO

FG 100V/AS56	FG 100B/AS56	FG 100R/AS56	FG 100D/AS56	FG 100W/AS56
--------------	--------------	--------------	--------------	--------------

SORTIDO 56 FERRAMENTAS ISOLADAS

1º GAVETA

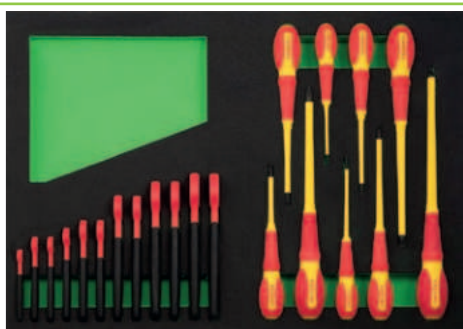

FG 100/03-IS: Módulo chaves de boca simples e chaves para parafusos isoladas
 - Chaves de boca simples isoladas 7-19mm
 - Chaves para parafusos de fenda 2.5x75mm, 3x100mm, 5.5x125mm, 6.5x150mm, 8x175mm
 - Chaves para parafusos Phillips PH0x60, PH1x80, PH2x100, PH3x150

2º GAVETA



FG 100/21-IS: Módulo chaves de caixa 1/2" e acessórios isolados
 - Chaves de caixa 1/2" 10-32mm
 - Chaves de ponta 1/2" baixos y longos 4-10mm
 - Acessórios de 1/2"

3º GAVETA

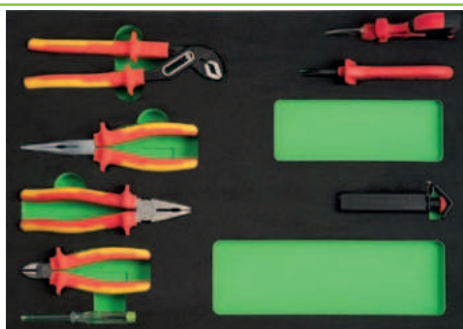

FG 100/39-IS: Módulo alicates e ferramentas de corte
 - Alicates isoladas
 - Tesoura isoladas
 - Navalha de descarnar cabo
 - Ferramenta para descarnar cabo

FG 603/TA1

~~278,00€~~ **159,00€**

TAPETE ISOLANTE 1.000V
 Dimensões 1.000 x 1.000 x 3 mm





CARROS E BANCOS

MÓDULO 14 CHAVES BOCA/LUNETAS MM

FG 600/B6,7,8,9,10,11,12,13,14,15,16,17,18,19mm

1/3



CÓDIGO	CHIAVE	€/LISTINO	€/PROMO
FG 100/03G	FG 600/B	160,00€	89,90€
FG 100/03G-A	FG 600/A	170,00€	99,90€

MÓDULO 6 CHAVES BOCA/LUNETAS MM

FG 600/B21,22,24,27,30,32mm

1/3

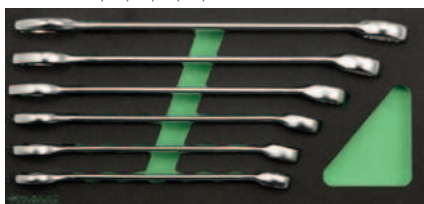

CÓDIGO	CHIAVE	€/LISTINO	€/PROMO
FG 100/03L	FG 600/B	158,00€	89,90€
FG 100/03L-A	FG 600/A	168,00€	99,90€

MÓDULO 18 CHAVES BOCA/LUNETAS MM

FG 600/B6,7,8,10,11,12,13,14,16,17,18,19,21,22,24,27,30,32mm

2/3



CÓDIGO	CHIAVE	€/LISTINO	€/PROMO
FG 100/03H	FG 600/B	295,00€	179,00€
FG 100/03H-A	FG 600/A	320,00€	189,00€

FG 100/03E

~~98,00€~~

59,90€

MÓDULO 8 CHAVES DE BOCAS

FG 602/B6x7,8x9,10x11,12x13,14x15,16x17,18x19,20x22 mm + FG 139C/FS

1/3

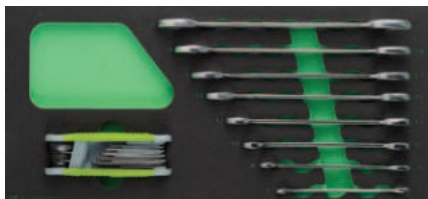

FG 100/03F

~~110,00€~~

69,00€

MÓDULO 5 CHAVES DE BOCAS

FG 602/B21x23,24x26,25x28,27x29,30x32 mm

1/3



FG 100/07C

~~112,00€~~

65,90€

MÓDULO 7 CHAVES DE LUNETA CURVADAS

FG 615/B6x7,8x9,10x11,12x13,14x15,16x17,18x19mm

1/3

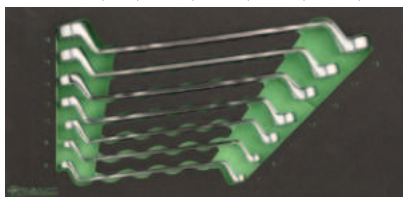

FG 100/07D

~~160,00€~~

95,90€

MÓDULO 5 CHAVES DE LUNETA CURVADAS

FG 615/B20x22,21x23,24x27,25x28,30x32mm

1/3



FG 100/08C

~~250,00€~~

159,00€

MÓDULO 8 CHAVES COM ROQUETE

FG 605/B8,10,11,12,13,14,15,16,17,18,19mm

1/3



FG 100/10C

~~390,00€~~

249,00€

MÓDULO 8 CHAVES EM T HEXAGONAIS

FG 618/A7,8,10,11,13,14,17,19 mm

1/1

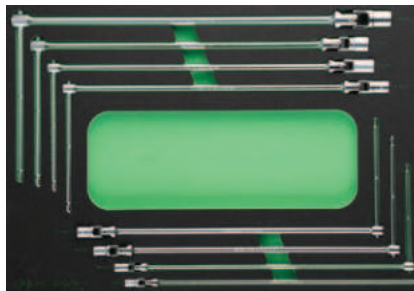

FG 100/10D

~~570,00€~~

349,00€

MÓDULO 12 CHAVES EM T HEXAGONAIS
FG 618/A7, 8,10,11,12,13,14,15,16,17,18,19 mm



1/1

FG 100/17

~~145,00€~~

79,90€

MÓDULO CHAVES DE CAIXAS 6PT
4-14mm



1/3

1/4"

FG 100/17E

~~290,00€~~

169,00€

MÓDULO CHAVES DE CAIXAS 6PT



1/3

1/4"

FG 100/18

~~295,00€~~

179,00€

MÓDULO CHAVES DE CAIXAS 6PT



1/3

3/8"

FG 100/19

~~230,00€~~

139,00€

MÓDULO CHAVES DE CAIXAS 6PT
9-19mm

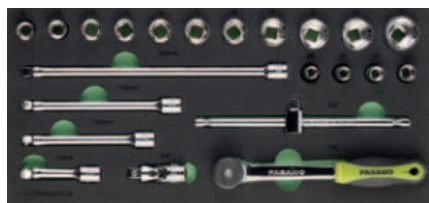

1/3

3/8"

MÓDULO CHAVES DE CAIXAS 6PT
10-23mm



1/3

1/2"

CÓDIGO	ATAQUE	€/LISTINO	€/PROMO
FG 100/21B	Sextavado	250,00€	149,00€
FG 100/21C	Poligonale	250,00€	149,00€

MÓDULO CHAVES DE CAIXAS 6PT
10-23mm

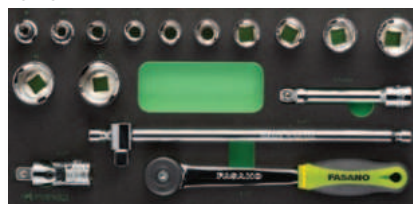

1/3

1/2"

CÓDIGO	ATAQUE	€/LISTINO	€/PROMO
FG 100/21M	Sextavado	170,00€	99,00€
FG 100/21D	Poligonale	170,00€	99,00€

FG 100/21H

~~440,00€~~

269,00€

MÓDULO CHAVES DE CAIXAS 6PT
Tomadas curtas: 8-32 mm (exceto 25 mm)
Tomadas longas: 10-32 mm

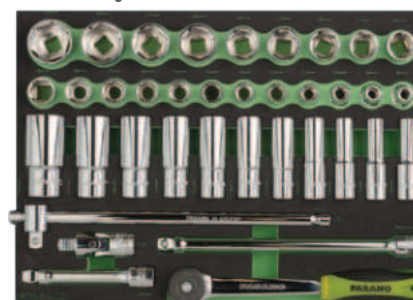

2/3

1/2"

FG 100/21TX

~~270,00€~~

159,00€

MÓDULO 44 FERRAMENTAS TORX

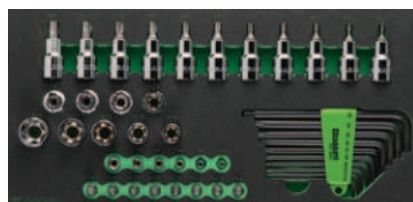

1/3

1/4"

1/2"

FG 100/81F

~~200,00€~~

119,00€

MÓDULO CHAVES DE PONTAS
FG 150/H2-H8, FG 150L/H2-H8, FG 150/M5-M16,
FG 150L/M5-M14

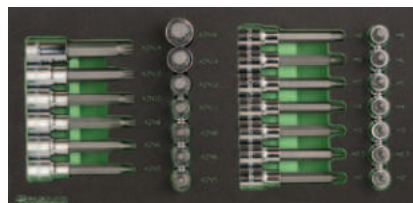

1/3

1/4"

1/2"



FG 100/23C

~~220,00€~~

129,00€

MÓDULO CHAVES DE CAIXAS DE IMPACTO

FG 628/C10, 11, 12, 13, 14, 15, 16, 17, 18, 19, 21, 22, 23, 24, 25, 26, 27, 30, 32mm



1/3

1/2"

FG 100/65C

~~136,00€~~

86,90€

MÓDULO DE ALICATES

FG 70/CJ250 - FG 58/A240 - FG 49/HE250



1/3

FG 100/23B

~~360,00€~~

219,00€

MÓDULO CHAVES DE CAIXAS DE IMPACTO

FG 628/L10, 11, 12, 13, 14, 15, 16, 17, 18, 19, 21, 22, 23, 24, 25, 27, 29, 30, 32mm



1/3

1/2"

FG 100/45D

~~69,00€~~

39,90€

MÓDULO DE 6 CHAVES DE FENDA

FG 22/3x100, 4x125, 5.5x200, 6.5x150, FG 22/PH1x80, PH2x150



1/3



FG 100/39XT

~~110,00€~~

66,90€

MÓDULO 3 ALICATES

FG 59/XT180 - FG 61/XT160 - FG 63/XT160

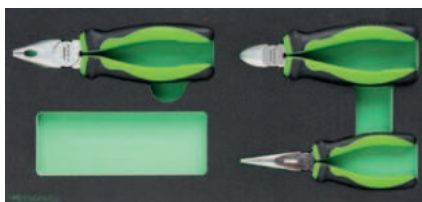

1/3

FG 100/45E

~~84,00€~~

49,90€

MÓDULO DE 8 CHAVES DE FENDA

3x100, 4x125, 5.5x150, 6.5x150, 6.5x38, PH1x80, PH2x150, PH2x38



1/3



MÓDULO 4 ALICATES DE FREIOS

FG 51/140, FG 52/140, FG 53/140, FG 54/140



1/3

FG 100/45F

~~70,00€~~

41,90€

MÓDULO DE 6 CHAVES DE FENDA

PH0x60, PH1x150, PH2x100, PH2x150, PH3x150, PH2x38



1/3



CÓDIGO	CAPACIDADE	€/LISTINO	€/PROMO
FG 100/41C	8-25mm	113,00€	66,90€
FG 100/42C	19-60mm	118,00€	73,90€

FG 100/65B

~~93,50€~~

54,90€

MÓDULO DE ALICATES

FG 58/B240, FG 69/CJ250



1/3

FG 100/45G

~~70,00€~~

41,90€

MÓDULO DE 7 CHAVES DE FENDA

2.5x60, 3x100, 3.5x100, 4x125, 5.5x150, 5.5x100, 6.5x150



1/3



FG 100/45I

~~85,00€~~

49,90€

MÓDULO DE 6 CHAVES DE FENDA
TX10, TX15, TX20, TX25, TX27, TX30



1/3



FG 100/50F

~~90,00€~~

53,90€

MÓDULO DE CHAVES MACHOS HEXAGONAIS
FG 142/2, 2.5, 3, 4, 5, 6

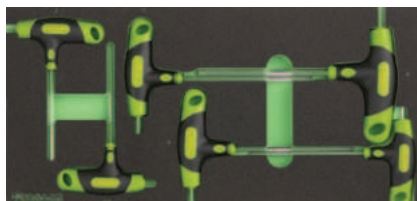

1/3



FG 100/45T

~~88,00€~~

52,90€

MÓDULO DE 5 CHAVES DE FENDA
FG 22/FX6, FX7, FX8, FX10, FX13



1/3



FG 100/50G

~~90,00€~~

53,90€

MÓDULO DE CHAVES MACHOS TORX
FG 143/TX10, TX15, TX20, TX25, TX27, TX30

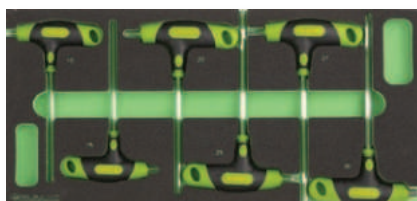

1/3



FG 100/45H

~~80,00€~~

49,00€

MÓDULO DE 5 CHAVES DE FENDA
FG 22/2.5x300, 4x400, 5.5x400, FG 22/PH1x400,
PH2x400

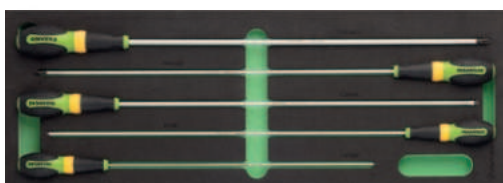

1/2



FG 100/56C

~~142,00€~~

89,90€

MÓDULO DE PERCUSSÃO
FG 132/500, FG 136/40 - FG 126/SN1, FG 126/SN3



1/3

FG 100/48G

~~130,00€~~

79,90€

MÓDULO DE PONTAS DE 10MM

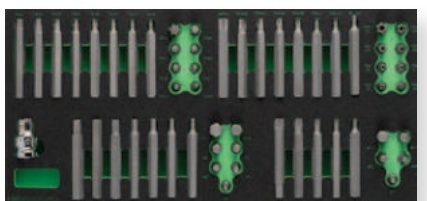

1/3



FG 100/54

~~188,00€~~

119,00€

MÓDULO FERRAMENTAS DE MEDIÇÃO
FG 95/CA, FG 188/2, FG 95/M1, FG 81/PT1, FG 44/MT5



1/3

FG 100/51H

~~145,00€~~

89,00€

MÓDULO DE CHAVES MACHOS HEXAGONAIS
FG 621/H2, 2.5, 3, 4, 5, 6, 8mm

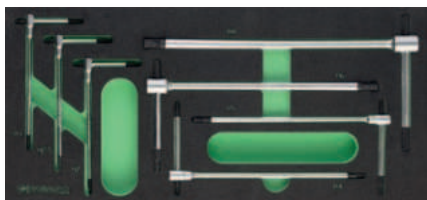

1/3



FG 100/76C

~~275,00€~~

169,00€

OS PLUGUES DO FILTRO DE ÓLEO E AS CHAVES SE FORMAM
FG 176/F01 - FG 176/RE - FG 175/S15



1/3



NEW

MÓDULOS DE BORRACHA GAVETA COMPLETA

TERMOFORMADOS SORTIDOS COM AS FERRAMENTAS ESPECÍFICAS DE UMA GAMA DE PRODUTOS



IMPRESSÃO BI-COLOR

CÓDIGO DE FERRAMENTA GRAVADO A LASER, PARA QUE POSSA ENCONTRAR TUDO O QUE PRECISA NUM RELANCE E POUPAR TEMPO.



FG 100/03M

MÓDULO DE CHAVES COMBINADAS POLIGONAIS E POLIGONAIS DE DUPLA CURVATURA

33 PEÇAS

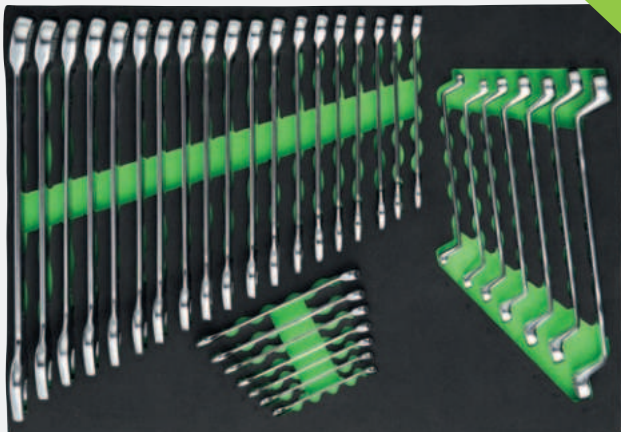

FG 600/B

Chaves poligonais de boca
6, 7, 8, 9, 10, 11, 12, 13, 14, 15, 16, 17, 18, 19, 20, 21, 22, 23, 24, 25, 26, 27, 28, 29, 30, 32



FG 615/B

Chaves de luneta com curvatura profunda
6x7, 8x9, 10x11, 12x13, 14x15, 16x17, 18x19



565,00€

279,00€

FG 100/45R

MÓDULO CHAVES PARA PARAFUSOS DE FENDA, PHILLIPS, HEXAGONAIS ESFÉRICAS Y TORX

25 PEÇAS

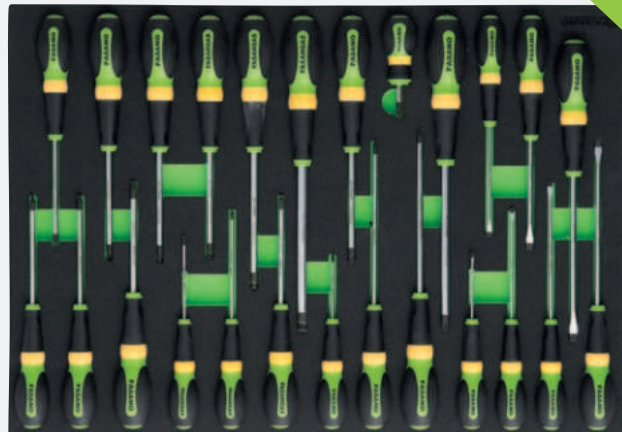

FG 22/PH

Chave de fenda para parafusos de perfil Phillips
0x60, 1x150, 2x100, 2x150, 3x150

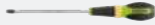

FG 22/PH

Chave de fenda para parafusos de perfil Phillips - Série Stubby
2x30



FG 22/

Chave para parafusos de perfil de fenda
2.5x60, 3x100, 3.5x100, 4x125, 5.5x150, 5.5x100, 6.5x150

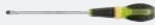

FG 22/TX

Chave de fenda para parafusos de perfil TORX
10, 15, 20, 25, 27, 30



FG 22/H

Chave hexagonais de extremidade esférica
2.5, 3, 4, 5, 6, 8



276,40€

149,00€

FG 100/39F
MÓDULO CHAVES PARA PARAFUSOS, ALICATES, Y PONTAS

128
PEÇAS



FG 22/PH
Chave de fenda para parafusos de perfil Phillips
1x150, 2x100

FG 22/
Chave para parafusos de perfil de fenda
3x100, 4x125, 5.5x100

FG 22/TX
Chave de fenda para parafusos de perfil TORX
10, 15, 20, 25, 27, 30

FG 59/XT180
Alicate universales
180mm

FG 63/XT160
Alicate de corte diagonal
160mm

FG 51/180
Alicate de freios exteriores
180mm

FG 53/180
Alicate de freios interiores
180mm

FG 139
Chaves machos hexagonais com extremidade esférica
1.5, 2, 2.5, 3, 4, 4.5, 5, 5.5, 6, 7, 8, 10

FG 85/S100
Jogo 98 pontas 1/4" + 2 porta pontas
PH 0, 1, 2, 3; PZ 0, 1, 2, 3; Tri-Wing 1, 2, 3, 4, 6, 8, 10; XZN 5, 6, 8;
TX 8, 9, 10, 15, 20, 25, 27, 30, 40, 45; S 0, 1, 2, 3;
TX 8, 10, 15, 20, 25, 27, 30, 35, 40; SL 3, 4, 4.5, 5, 5.5, 6, 6.5, 7;
H 1.5, 2, 2.5, 3, 4, 5, 5.5, 6, 1/16, 5/64, 3/32, 7/64, 1/8, 9/64,
5/32, 3/16, 7/32, 1/4;
HTR 2, 2.5, 3, 4, 5, 6, 5/64, 3/32, 7/64, 1/8, 9/64, 5/32; SP 4, 6, 8, 10;
SP 5/32, 3/16, 1/4 + 2 porta pontas 1/4"

FG 88/P14
Porta pontas com pega bi-material
258mm

432,00€ **239,00€**

FG 100/39E
MÓDULO DE ALICATES Y PONTAS

122
PEÇAS



FG 59/XT180
Alicate universal
180mm

FG 63/XT160
Alicate de corte diagonal
160mm

FG 61/XT160
Alicate de pontas rectas
160mm

FG 69/CJ250
Alicate de pressão, maxilas côncavas
250mm

FG 58/B240
Alicate ajustável com charneira sobreposta
240mm

FG 85/S100
Jogo 98 pontas 1/4" + 2 porta pontas
PH 0, 1, 2, 3; PZ 0, 1, 2, 3; Tri-Wing 1, 2, 3, 4, 6, 8, 10; XZN 5, 6, 8;
TX 8, 9, 10, 15, 20, 25, 27, 30, 40, 45; S 0, 1, 2, 3;
TX 8, 10, 15, 20, 25, 27, 30, 35, 40; SL 3, 4, 4.5, 5, 5.5, 6, 6.5, 7;
H 1.5, 2, 2.5, 3, 4, 5, 5.5, 6, 1/16, 5/64, 3/32, 7/64, 1/8, 9/64,
5/32, 3/16, 7/32, 1/4;
HTR 2, 2.5, 3, 4, 5, 6, 5/64, 3/32, 7/64, 1/8, 9/64, 5/32; SP 4, 6, 8, 10;
SP 5/32, 3/16, 1/4 + 2 porta pontas 1/4"

FG 88/P14
Porta pontas com pega bi-material

FG 139
Chaves machos hexagonais com extremidade esférica
1.5, 2, 2.5, 3, 4, 4.5, 5, 5.5, 6, 7, 8, 10

FG 51/180
Alicate de retenes exteriores
180mm

FG 52/180
Alicate de freios exteriores com pontas curvas 90°
180mm

FG 53/180
Alicate de freios interiores
180mm

FG 54/180
Alicate de freios interiores com pontas curvas 90°
180mm

475,40€ **269,00€**



CARROS E BANCOS

FG 100/21F

MÓDULO 1/4", 1/2", 3/8" CHAVES DE CAIXA HEXAGONAIS E ACESSÓRIOS

115
PEÇAS



FG 624/E - FG 624E/L
Chaves de caixa de 1/4" - séries normal e longa
4, 5, 6, 7, 8, 9, 10, 11, 12, 13, 14



FG 624/CR14
Roquete reversível, quadra 1/4"-72 dentes

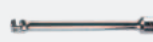

FG 624/PA
Extensões quadras macho fêmea de 1/4" angulares
50, 100mm



FG 624/PR150
Extensões quadras macho fêmea de 1/4"
150mm



FG 624/ES14
Cabo t correção, quadra de 1/4"



FG 624/SN14
Cardam com quadras macho e fêmea de 1/4"



FG 624/GR14C
Quadrado macho de 1/4" com pega



FG 147/H
Chaves de caixa com ponta hexagonal 1/4"
2,5, 3, 4, 5, 6, 7, 8, 10



FG 147/PH
Chaves de caixa com ponta de perfil Phillips - 1/4"
1, 2, 3, 4



FG 147/TX
Chaves de caixa com ponta de perfil Torx 1/4"
9, 10, 15, 20, 25, 27, 30, 40



FG 147/SL
Chaves de caixa com ponta de perfil de fenda 1/4"
4, 5,5, 6,5, 8, 10



FG 139/L
Chaves machos hexagonais com extremidade esférica - série longa
1,5, 2, 2,5, 3, 4, 4,5, 5, 5,5, 6, 7, 8, 10



FG 624B/PA
Extensões quadras macho fêmea de 3/8" angulares
75, 125, 150, 250



FG 624/SN38
Cardam com quadras macho e fêmea de 3/8"



FG 624/ES38
Cabo t correção, quadra de 3/8"



FG 624/CR38
Roquete reversível, quadra 3/8"-72 dentes



FG 624/B
Chave de caixa 3/8" hexagonal
8, 9, 10, 11, 12, 13, 14, 15, 16, 17, 18, 19, 21, 22, 23



FG 625/A
Chave de caixa 1/2" hexagonal
8, 9, 10, 11, 12, 13, 14, 15, 16, 17, 18, 19, 20, 21, 22, 23, 24, 25, 26, 27, 30, 32



FG 625/PA
Extensões quadras macho fêmea de 1/2" angulares
125, 250

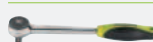

FG 625/CR12
Roquete reversível, quadra 1/2"-72 dentes



FG 625/SN12
Cardam com quadras macho e fêmea de 1/2"



FG 625/ES12
Cabo t correção, quadra de 1/2"

1.030,00€

599,00€

FG 100/81G

MÓDULO CHAVES DE PONTA 1/4" E 1/2"

118
PEÇAS



FG 150/H
Chaves de ponta de perfil macho hexagonal 1/2"
2, 2,5, 3, 4, 5, 6, 8



FG 150L/H
Chaves de ponta de perfil macho hexagonal 1/2" - inserção longa
2, 2,5, 3, 4, 5, 6, 8



FG 150/M
Chaves de ponta XZN 1/2"
5, 6, 8, 10, 12, 14, 16



FG 150L/M
Chaves de ponta XZN 1/2" - inserção longa
5, 6, 8, 10, 12, 14



FG 624/TX
Chave de caixa 1/4" Torx
4, 5, 6, 7, 8, 10



FG 625/TX
Chave de caixa 1/2" Torx
8, 10, 12, 14, 16, 18, 20, 22, 24



FG 147/TX
Chaves de caixa com ponta de perfil Torx 1/4"
9, 10, 15, 20, 25, 27, 30, 40



FG 150/TX
Chaves de ponta de perfil Torx 1/2"
10, 15, 20, 25, 27, 30, 40, 45, 50, 55, 60



FG 138/C
Chaves macho Torx
TX9, TX10, TX15, TX20, TX25, TX27, TX30, TX40, TX45, TX50



FG 150/R
Chaves de porta de perfil RIBE 1/2"
4, 5, 6, 7, 8, 9, 10, 11, 12, 13, 14



FG 150L/R
Chaves de ponta de perfil RIBE 1/2" série longa
4, 5, 6, 7, 8, 9, 10, 11, 12, 13, 14



FG 147/H
Chaves de caixa com ponta hexagonal 1/4"
2,5, 3, 4, 5, 6, 7, 8, 10



FG 147/PH
Chaves de caixa com ponta de perfil Phillips - 1/4"
1, 2, 3, 4



FG 147/PT
Chaves de caixa com ponta 5 nervuras e furo central - 1/4"
1, 2, 3, 4



FG 147/SL
Chaves de caixa com ponta de perfil de fenda 1/4"
4, 5,5, 6,5, 8, 10



FG 624/CS14
Cabo articulado com punho, quadra 1/4"



FG 625/CS12
Cabo articulado com punho, quadra 1/2"

1.366,00€

499,00€

FG 100/56D

MÓDULO DE FERRAMENTAS DE MANUTENÇÃO GERAL

15
PEÇAS



FG 132/500
Martelos para mecânico com cabo de resina 500 Gr

FG 136/30
Martelos com batentes plásticos intercambiável 30 Ø/mm

FG 126/SN
Escopros planos série nervurada 125mm, 200mm

FG 95/CA
Paquímetro leitura cinquagesimal 150mm

FG 80/8AR
Limas meio-murças com punhos - redondo 8"

FG 80/8AM
Limas meio-murças com punhos - medio redondo 8"

FG 80/8AP
Limas meio-murças com punhos - plana 8"

FG 80/8AQ
Limas meio-murças com punhos - triangular 8"

FG 80/8AT
Limas meio-murças com punhos - quadrado 8"

FG 50/AR
Serra de recortes compacta com pega Hoja 140mm

FG 48/LG
X-acto com lâmina longa 16.7mm

FG 497/OP2
Oleador pressurizado com palhinha de latão embutida 80cc

FG 44/MT5
Fitas métricas, fita em aço 5 metri

FG 79/SP4
Escova com fios de aço ondulados revestidos a latão 270mm

~~364,00€~~ 229,00€

FG 100/95B

MÓDULO DE FERRAMENTAS PARA LOJA DE PNEUS

18
PEÇAS



FG 536/2
Chaves dinamométricas reversível, para aperto direito-1/2" 40-200Nm

FG 628/R
Chaves de porcas para rodas 17,19,21mm

FG 198/PE
Alicate de remoção de pesos de equilíbrio das rodas

FG 186P/S4
4 Colheres de nylon

FG 628R/L
Chaves de porcas para rodas - modelo longo 17,19,21mm

FG 126/P500
Ferros de desmontar rodas de liga leve

FG 628/R
Chaves de porcas para rodas 16.5x17.5,18.5x19.5,21x21.5,22x22.5,27x27.5

~~684,50€~~ 399,00€

FG 100/95C

MÓDULO DE FERRAMENTAS PARA LOJA DE PNEUS

41
PEÇAS



FG 628/R
Chaves de porcas para rodas 17,19,21mm

FG 628/C
Chave de caixa 1/2" hexagonal reforçado 10,11,12,13,14,15,16,17,18,19,20,21,22,23,24,25,26,27,30,32mm

FG 628/L
Chave de caixa 1/2" hexagonais reforçado - série longa 10,13,14,17,19,21,22,24

FG 152/RH
Chave de ponta reforçada hexagonais de 1/2" 5,6,7,8,10,12,14,17,19

FGA 309
Chave de impacto 1/2"

~~818,50€~~ 449,00€



FG 128/2

~~700,00€~~

349,00€

BANCADA THE TRABALHO 2.0MT

Prateleira superior em chapa de aço galvanizado de 2 mm

Peso total: 59,5 kg

Capacidade de carga estática: 2000 Kg

Dimensões: 2000x670x880 mm



FG 128/D2

~~950,00€~~

479,00€

BANCADA THE TRABALHO 2.0MT EQUIPADO COM 2 GAVETAS

Prateleira superior em chapa de aço galvanizado de 2 mm

Peso total: 74,5 kg

Capacidade de carga estática: 2000 Kg

Dimensões: 2000x670x880 mm



FG 128/D2



FG 128/B2



FG 128/R2



FG 129/2

~~850,00€~~

449,00€

BANCADA THE TRABALHO 2.0MT

Prateleira superior em chapa de aço galvanizado de 3 mm

Peso total: 77 kg

Capacidade de carga estática: 2000 Kg

Dimensões: 2000x745x880 mm



FG 129/D2

~~1.100,00€~~

579,00€

BANCADA THE TRABALHO 2.0MT EQUIPADO COM 2 GAVETAS

Prateleira superior em chapa de aço galvanizado de 3 mm

Peso total: 92 kg

Capacidade de carga estática: 2000 Kg

Dimensões: 2000x745x880 mm



FG 129/D2



FG 129/B2



FG 129/R2



FG 129/1

~~550,00€~~

289,00€

BANCADA THE TRABALHO 1.0MT

Prateleira superior em chapa de aço galvanizado de **3 mm**
Prateleira inferior em chapa de aço fornecida de série
2 montantes
Disposições para fixação ao solo
Estrutura pintada com tinta epoxi
Peso total: 58 Kg
Capacidade de carga estática: 2000 Kg
Dimensões: 1000x745x880 mm



FG 129/D1

~~690,00€~~

359,00€

BANCADA THE TRABALHO 1.0MT EQUIPADO COM 1 GAVETAS

Prateleira superior em chapa de aço galvanizado de **3 mm**
Prateleira inferior em chapa de aço fornecida de série
2 montantes
Disposições para fixação ao solo
Estrutura pintada com tinta epoxi
Peso total: 64.5 Kg
Capacidade de carga estática: 2000 Kg
Dimensões: 1000x745x880 mm



FG 129/D1



FG 129/B1



FG 129/R1



FG 129/1.5

~~650,00€~~

339,00€

BANCADA THE TRABALHO 1.5MT

Prateleira superior em chapa de aço galvanizado de **3 mm**
Prateleira inferior em chapa de aço fornecida de série
2 montantes
Disposições para fixação ao solo
Estrutura pintada com tinta epoxi
Peso total: 77 Kg
Capacidade de carga estática: 2000 Kg
Dimensões: 1500x745x880 mm



FG 129/D1.5

~~790,00€~~

419,00€

BANCADA THE TRABALHO 1.5MT EQUIPADO COM 1 GAVETAS

Prateleira superior em chapa de aço galvanizado de **3 mm**
Prateleira inferior em chapa de aço fornecida de série
2 montantes
Disposições para fixação ao solo
Estrutura pintada com tinta epoxi
Peso total: 83.5 Kg
Capacidade de carga estática: 2000 Kg
Dimensões: 1500x745x880 mm



FG 129/D1.5



FG 129/B1.5



FG 129/R1.5



CARROS E BANCOS



FG 137/D1.5

~~1.400,00€~~

739,00€

BANCADA ESPECIAL 1.5MT COM TANQUE DE COLETA E RODAS GIRATÓRIAS

Peso total: 90 Kg
Dimensões: 1500x745x880 mm
Prateleira microperfurada



FG 137/D1.5

FG 137/B1.5

FG 137/R1.5

FG 131/D2

~~1.700,00€~~

899,00€

BANCADA PROFISIONAL - 2.0M EQUIPADA COM 5 GAVETAS

Peso total: 121.5 Kg
Dimensões: 2000x670x920 mm



FG 131/D2

FG 131/B2

FG 131/R2

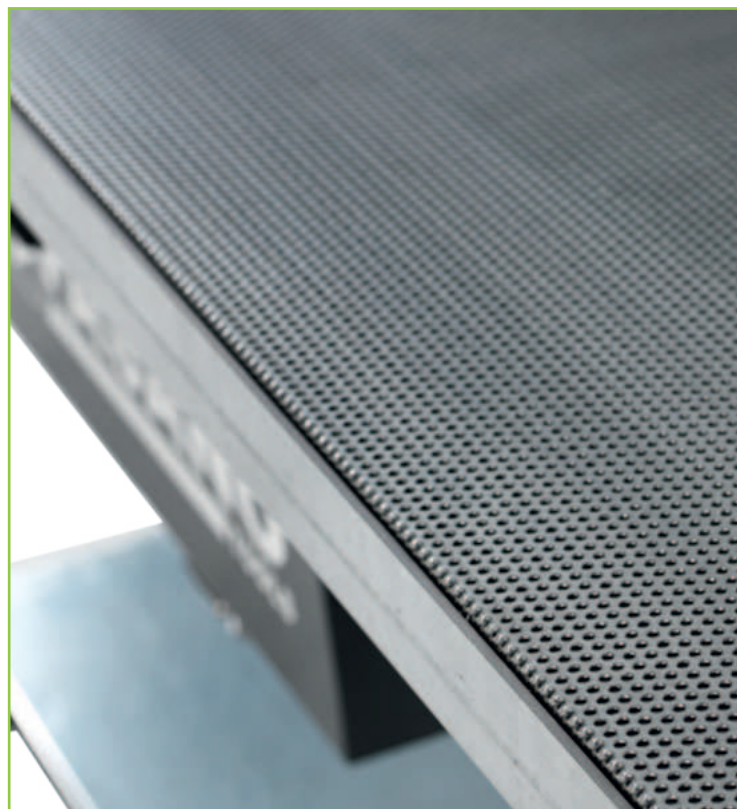



FG 107/A

~~165,00€~~

89,00€

CARRO PORTA FERRAMENTAS

Chapa de aço: 1mm
 2 rodízios fixos e 2 rodízios giratórios com travão (Ø100mm)
 Profundidade da prateleira: 7,8 cm
 Capacidade de carga estática distribuída por 3 prateleiras: 90 kg
 Dimensões: 730x380x780
 Peso kg: 16,4



FG 106/B

~~320,00€~~

189,00€

CARRO PORTA FERRAMENTAS

Dimensões: 460x930x885 mm
 Chapa de aço de 1,5 mm
 Rodas montadas em suporte de placa rotativa com unidade de rolamento duplo de esferas
 2 fixas, 1 giratória + 1 roda giratória com travão (Ø100mm)
 Peso total: 22 Kg



FG 106/C

~~420,00€~~

229,00€

CARRO PORTA FERRAMENTAS

Dimensões: 560x1000x950 mm
 Chapa de aço 2,0 mm
 Rodas montadas em suporte de placa giratória com unidade de rolamento duplo de esferas
 2 fixas, 1 giratória + 1 rodízio giratório com travão (Ø125mm)
 Peso total: 44 Kg



MADE IN ITALY



PRODUÇÃO
100% MADE IN ITALY

MOBILIÁRIO FG 118 TÉCNICO



PINTURA
SEMIBRILHO

OS DETALHES QUE FAZEM A DIFERENÇA

TOMADAS COM LIGAÇÕES STANDARD, SCHUKO E USB
CÓMODAS COM GAVETAS TOTALMENTE EQUIPADAS
PODE SER ABERTO E EQUIPADO COM MATS
EM BORRACHA RESISTENTE A RISCOS

- ARMÁRIOS COM 4 PRATELEIRAS INTERNAS E DOBRADIÇAS DE FECHO AUTOMÁTICO
- REVESTIMENTO SUPERIOR EM POLICARBONATO E NOVO ACABAMENTO RESISTENTE A RISCOS
- MÓVEIS DE PAREDE COM PORTAS EQUIPADAS COM PISTÕES A GÁS





FG 118/C030V

~~7.670,00€~~

3.399,00€

CONFIGURAÇÃO TÉCNICA DO MOBILIÁRIO 3050MM

FG 118V/205A: Estrutura básica para configuração de 2050mm, equipada com 2 unidades de parede superiores

FG 118D/40A: Módulo fixo com portas

FG 118D/7T: Módulo móvel com 7 gavetas

FG 118/69D7: Módulo fixo com 7 gavetas

FG 118/AR1D: Armário alto com portas

FG 118/AR1D: Armário alto com portas

Dimensão mm (LxPxH): 3050x757x2000

MADE IN ITALY



FG 118/C030D



FG 118/C030B



FG 118/C030R



FG 118/C02V

5.840,00€

2.499,00€

CONFIGURAÇÃO TÉCNICA DO MOBILIÁRIO 2050MM

Configuração composta por:

FG 118V/69A: Módulo de armários com 2 portas

FG 118V/7T: Gaveteiro móvel com 7 gavetas

FG 118V/40F: Módulo porta-papel com gaveta de resíduos

2 porta-ferramentas

2 tomadas fornecidas: 1 x tomada de 2 pinos 220V, 1 x tomada de 2 pinos Schuko + USB

Dimensões: 2050x757x2000 mm

MADE IN ITALY



FG 118/C02D



FG 118/C02B



FG 118/C02R



FG 118/C03V

6.620,00€

2.899,00€

CONFIGURAÇÃO TÉCNICA DO MOBILIÁRIO 2550MM

Configuração composta por:

FG 118V/AR1V: Armário metálico de arrumação com 1 porta

FG 118V/69A: Módulo de armário com 2 portas

FG 118V/7T: Gaveteiro móvel com 7 gavetas

FG 118V/40F: Módulo porta-papéis com gaveta de resíduos

2 porta-ferramentas

2 tomadas fornecidas: 1 x tomada de 2 pinos 220V, 1 x tomada de 2 pinos Schuko + USB

Dimensões: 2550x757x2000 mm

MADE IN ITALY



FG 118/C03D



FG 118/C03B



FG 118/C03R

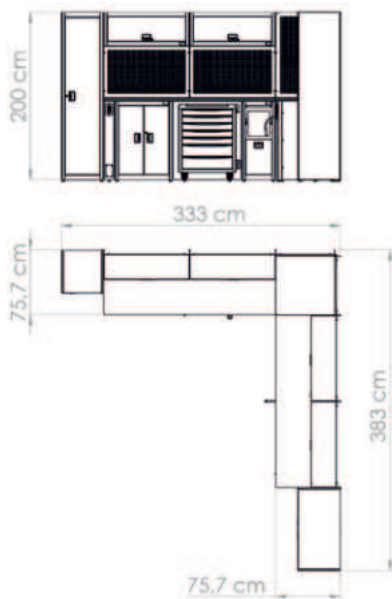

FG 118/C022V

15.260,00€

7.899,00€

CONFIGURAÇÃO TÉCNICA DE MÓVEIS DE CANTO A PARTIR DE 7160

Configuração composta por:

- FG 118/AR1V: Armário lateral de 500mm
- FG 118V69A: Módulo de armário de 2 portas
- FG 118V/7T: Módulo de gavetas móvel com 7 gavetas
- FG 118V/40F: Módulo porta-papel com gaveta de resíduos
- FG 118V/80AN: Armário de canto equipado com porta-ferramentas
- FG 118V/69E: Módulo de caixote do lixo
- FG 118M/40D: Módulo de distribuição de ar comprimido
- FG 118/69V7: Móvel de gavetas fixo com 7 gavetas
- FG 118/AR2V: Armário lateral com duas portas
- 4 armários superiores de parede equipados com pistões de gás e fechadura
- 4 porta-ferramentas
- 2 tomadas cada uma composta por 1 tomada 220V de 2 pinos, 1 tomada Schuko de 2 pinos, 1 tomada USB
- Dimensões 2500x3030x757x2000 mm

MADE IN ITALY



FG 118/C022D



FG 118/C022B



FG 118/C022R



NEW

MADE IN ITALY



**NOVO SISTEMA
DE MOBILIÁRIO
TÉCNICO**

FG 117



NOVA CÔMODA FG 117
DISPONÍVEL EM 4 VARIAÇÕES DE CORES

NOVO PLANO DE TRABALHO

ESTANTE PINTADA EQUIPADA DE TOPO EM
POLICARBONATO RESISTENTE A RISCOS

DESIGN MAIS ELEGANTE E FUNCIONAL

COM CANTOS ARREDONDADOS



**PRATELEIRAS
INTERIORES**



**PINTURA DE
CETIM MATE**



**COMPOSIÇÃO
COMPACTO COM APENAS
51 CM DE PROFUNDIDADE**



NEW



FG 117/C024V

~~6.000,00€~~

2.499,00€

CONFIGURAÇÃO TÉCNICA DO MOBILIÁRIO 3065MM

FG 117V/207A: Estrutura básica equipada com 3 porta-ferramentas e 3 unidades de parede superiores

FG 117D/7G: Gaveteiro móvel com 7 gavetas

FG 117/68D7: Móvel de gavetas fixo com 7 gavetas

FG 117V/68B: Módulo porta-papéis com gaveta de resíduos

FG 117/AR2V: Armário lateral com duas portas

Dimensões mm (LxPxH): 3065x510x2000

MADE IN ITALY



FG 117/C024D



FG 117/C024B



FG 117/C024R



FG 117V/AS210

5.325,00€ 2.699,00€

CONFIGURAÇÃO TÉCNICA DO MOBILIÁRIO COM SORTIDO 210 FERRAMENTAS

FG 117V/207A: Estrutura básica equipada com 3 porta-ferramentas e 3 unidades de parede superiores

FG 117/68D7: Móvel de gavetas fixo com 7 gavetas

FG 117V/68A: Módulo de armário com 2 portas

FG 117V/68B: Módulo porta-papéis com gaveta de resíduos

FG 117/AR1V: Armário lateral com 1 portas

Sortido 210 ferramentas



FG 117D/AS210



FG 117B/AS210



FG 117R/AS210

MADE IN ITALY



1° CASSETTO



- FG 102/03G: Módulo 14 chaves boca/lunetas poligonais 6-19mm
- FG 102/03L: Módulo 6 chaves de bocas
- FG 102/21B: Módulo 25 ferramentas 1/2"

2° CASSETTO



- FG 102/17E: Módulo 18 ferramentas de 1/4"
- FG 102/19: Módulo 18 ferramentas 3/8"
- FG 102/45I: Módulo rígido 6 chaves de fenda torx

3° CASSETTO



- FG 102/39XT: Módulo 3 alicates
- FG 102/42C: Módulo rígido 4 alicates de freios
- FG 102/45D: Módulo rígido 6 chaves de fenda sl e ph

4° CASSETTO



- FG 102/56C: Módulo rígido ferramentas de percussão
- FG 102/65B: Módulo rígido 2 alicates ajustavel
- FG 102/48G: Módulo rígido 52 pontas de 10mm





FG 117/C02V

~~4.525,00€~~

1.799,00€

CONFIGURAÇÃO TÉCNICA DO MOBILIÁRIO 2065MM

- FG 117V/207A: Estrutura básica equipada com 3 porta-ferramentas e 3 unidades de parede superiores
- FG 117V/68A: Módulo de armário com 2 portas
- FG 117V/7G: Gaveteiro móvel com 7 gavetas
- FG 117V/68B: Módulo porta-papéis com gaveta de resíduos
- Dimensões mm (LxPxH): 2070x490x2000

MADE IN ITALY



FG 117/C02D



FG 117/C02B



FG 117/C02R



FG 117/C03V

~~5.245,00€~~

1.999,00€

CONFIGURAÇÃO TÉCNICA DO MOBILIÁRIO 2065MM + ARMÁRIO

- FG 117V/207A: Estrutura básica equipada com 3 porta-ferramentas e 3 unidades de parede superiores
- FG 117V/68A: Módulo de armário com 2 portas
- FG 117V/7G: Gaveteiro móvel com 7 gavetas
- FG 117V/68B: Módulo porta-papéis com gaveta de resíduos
- FG 117/AR1V: Armário lateral com 1 portas
- Dimensões mm (LxPxH): 2565x510x2000

MADE IN ITALY



FG 117/C03D



FG 117/C03B



FG 117/C03R



FG 117/C016V

3.665,00€

1.599,00€

CONFIGURAÇÃO TÉCNICA DO MOBILIÁRIO 1380MM + ARMÁRIO

FG 117V/138A: Estrutura básica equipada com 2 porta-ferramentas e 2 unidades de parede superiores

FG 117V/68A: Módulo de armário com 2 portas

FG 117/68V5: Móvel de gavetas fixo com 5 gavetas

FG 117/AR1V: Armário lateral com 1 portas

Dimensões mm (LxPxH): 1875x510x2000

MADE IN ITALY



FG 117/C016D



FG 117/C016B



FG 117/C016R

FG 117/C030V

8.480,00€

3.499,00€

CONFIGURAÇÃO TÉCNICA DE MÓVEIS DE CANTO

FG 117V/207A: Estrutura básica equipada com 3 porta-ferramentas e 3 unidades de parede superiores

FG 117V/138A: Estrutura básica equipada com 2 porta-ferramentas e 2 unidades de parede superiores

FG 117V/68B: Módulo porta-papéis com gaveta de resíduos

FG 117V/7G: Gaveteiro móvel com 7 gavetas

FG 117/68V6: Móvel de gavetas fixo com 6 gavetas

FG 117V/68A: Módulo de armário com 2 portas

FG 117V/68A: Módulo de armário com 2 portas

Dimensões mm (LxPxH): 2566x490x2000 + 1885x490x2000

MADE IN ITALY



FG 117/C030D



FG 117/C030B



FG 117/C030R

FG 120
MAXI
>STATION<

COM A NOVA ESTAÇÃO MÓVEL
FASANO TOOLS, O TRABALHO TORNA
SE AINDA MAIS VERSÁTIL E FLEXÍVEL



PUXADOR DE AÇO INOXIDÁVEL



GAVETAS COM ABERTURA TOTAL

PRATELEIRA SUPERIOR
EM AÇO COM TOP
EM POLICARBONATO



NOVA TINTA
SATIN MATE

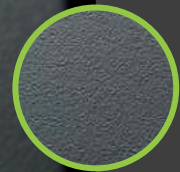

CAPAS DE
RODAS
DOBRÁVEIS





FG 120/C01V

2.690,00€

1.189,00€

CONFIGURAÇÃO MAXI STATION

Prateleira superior em aço com cobertura em policarbonato
 Envernizamento mate enrugado
 Pega em aço inoxidável
 Gavetas de abertura total completo com tapetes anti-riscos e com divisórias
 Coberturas de rodas dobráveis
 4 rodas giratórias Ø 125mm com corpo em polipropileno e borracha vulcanizada (2 com travão)
 Composto por:
 FG 120V/7T - Módulo de gavetas fixo de 7 gavetas
 FG 120V/A - Módulo fixo de uma porta
 FG 120V/A - Módulo fixo de uma porta
 Dimensão mm (LxPxH): 1540x460x1030



MADE IN ITALY



FG 120/C01D



FG 120/C01B



FG 120/C01R



FG 120/C02V

2.690,00€

1.249,00€

CONFIGURAÇÃO MAXI STATION

Prateleira superior em aço com cobertura em policarbonato
 Envernizamento mate enrugado
 Pega em aço inoxidável
 Gavetas de abertura total completo com tapetes anti-riscos e com divisórias
 Coberturas de rodas dobráveis
 4 rodas giratórias Ø 125mm com corpo em polipropileno e borracha vulcanizada (2 com travão)
 Composto por:
 FG 120V/7T - Módulo de gavetas fixo de 7 gavetas
 FG 120V/A - Módulo fixo de uma porta
 FG 120V/B - Módulo para rolo de papel, com gaveta de lixo
 Dimensão mm (LxPxH): 1540x460x1030



MADE IN ITALY



FG 120/C02D



FG 120/C02B



FG 120/C02R



FG 120/C03V

~~2.790,00€~~

1.289,00€

CONFIGURAÇÃO MAXI STATION

Prateleira superior em aço com cobertura em policarbonato
 Envernizamento mate enrugado
 Pega em aço inoxidável
 Gavetas de abertura total completo com tapetes anti-riscos e com divisórias
 Coberturas de rodas dobráveis
 4 rodas giratórios Ø 125mm com corpo em polipropileno e borracha vulcanizada (2 com travão)
 Composto por:
 FG 120V/7T - Módulo de gavetas fixo de 7 gavetas
 FG 120V/A - Módulo fixo de uma porta
 FG 120V/C - Módulo fixo para ar comprimido
 Dimensão mm (LxPxH) 1540x460x1030



MADE IN ITALY



FG 120/C03D

FG 120/C03B

FG 120/C03R



FG 120/C04V

~~2.960,00€~~

1.399,00€

CONFIGURAÇÃO MAXI STATION

Prateleira superior em aço com cobertura em policarbonato
 Envernizamento mate enrugado
 Pega em aço inoxidável
 Gavetas de abertura total completo com tapetes anti-riscos e com divisórias
 Coberturas de rodas dobráveis
 4 rodas giratórios Ø 125mm com corpo em polipropileno e borracha vulcanizada (2 com travão)
 Composto por:
 FG 120V/7T - Módulo de gavetas fixo de 7 gavetas
 FG 120V/B - Módulo para rolo de papel, com gaveta de lixo
 FG 120M/E - Módulo fixo para ar comprimido + 3 enchuffs (1 shuko 16a + 2 bivalentes 16a)
 Dimensão mm (LxPxH) 1540x460x1030



MADE IN ITALY



FG 120/C04D

FG 120/C04B

FG 120/C04R



FG 120V/AS217

~~4.204,50€~~

1.699,00€

MAXI STATION FG 120 COM UM SORTIDO DE 217 FERRAMENTAS

Prateleira superior em aço com cobertura em policarbonato

Envernizamento mate enrugado

Pega em aço inoxidável

Gavetas de abertura total completo com tapetes anti-riscos e com divisórias

Coberturas de rodas dobráveis

4 rodas giratórios Ø 125mm com corpo em polipropileno e borracha vulcanizada (2 com travão)

Composto por:

FG 120V/7T - Módulo de gavetas fixo de 7 gavetas

FG 120V/A - Módulo fixo de uma porta

FG 120V/B - Módulo para rolo de papel, com gaveta de lixo

Dimensão mm (LxPxH): 1540x460x1030

Sortido 217 ferramentas



FG 120D/AS217



FG 120B/AS217



FG 120R/AS217



MADE IN ITALY

1° CASSETTO

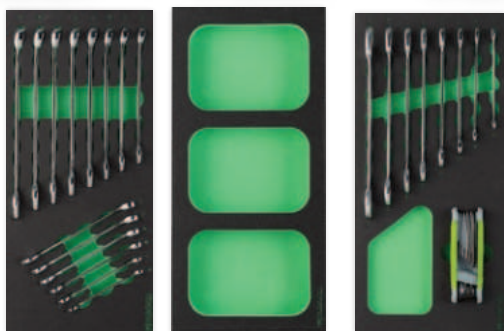

- FG 100/03G: Módulo 14 chaves boca/lunetas poligonais 6-19mm
- FG 100/VA1: Módulo rígido porta-objectos
- FG 100/03E: Módulo 8 chaves de bocas + Jogo de 9 chaves sextavadas macho

2° CASSETTO



- FG 100/17: Módulo 18 ferramentas de 1/4"
- FG 100/19: Módulo chaves de caixas 6PT
- FG 100/21B: Módulo 25 ferramentas 1/2"

3° CASSETTO



- FG 100/39XT: Módulo 3 alicate
- FG 100/48E: Módulo 98 insertos de 1/4" + 2 suportes e espaço vazio
- FG 100/65B: Módulo de alicates

4° CASSETTO



- FG 100/45F: Módulo 6 chaves de fenda
- FG 100/45G: Módulo de 7 chaves de fenda
- FG 100/56C: Módulo de percussão



MAXI STATION FG 120 COM UM SORTIDO DE 217 FERRAMENTAS

FG 120V/AS224

~~4.468,00€~~ **1.799,00€**

MAXI STATION FG 120 COM UM SORTIDO DE 224 FERRAMENTAS

Prateleira superior em aço com cobertura em policarbonato
 Envernizamento mate enrugado
 Pega em aço inoxidável
 Gavetas de abertura total completo com tapetes anti-riscos e com divisórias
 Coberturas de rodas dobráveis
 4 rodas giratórios ø 125mm com corpo em polipropileno e borracha vulcanizada (2 com travão)
 Composto por:
 FG 120V/7T - Módulo de gavetas fixo de 7 gavetas
 FG 120V/A - Módulo fixo de uma porta
 FG 120V/B - Módulo para rolo de papel, com gaveta de lixo
 Dimensão mm (LxPxH): 1540x460x1030
 Sortido 224 ferramentas



FG 120D/AS224



FG 120B/AS224



FG 120R/AS224



MADE IN ITALY

1° CASSETTO

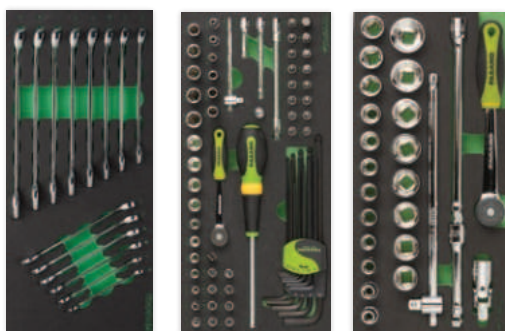

- FG 100/03G: Módulo 14 chaves boca/lunetas poligonais 6-19mm
- FG 100/17E: Módulo 65 ferramentas de 1/4"
- FG 100/21B: Módulo 25 ferramentas 1/2"

2° CASSETTO

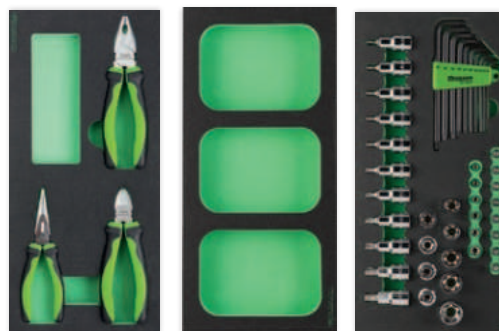

- FG 100/39XT: Módulo 3 alicate
- FG 100/VA1: Módulo rígido porta-objectos
- FG 100/21TX: Módulo rígido 44 ferramentas torx

3° CASSETTO

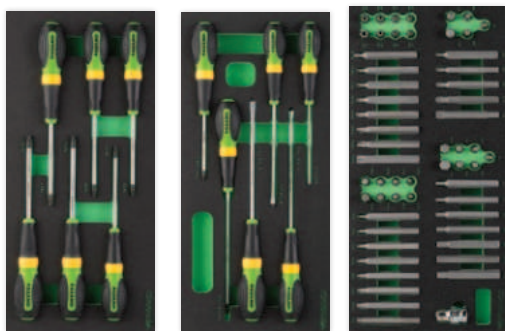

- FG 100/45I: Módulo de 6 chaves Torx
- FG 100/45D: Módulo 6 chaves de fenda SL e PH
- FG 100/48G: Módulo 52 pontas de 10mm

4° CASSETTO

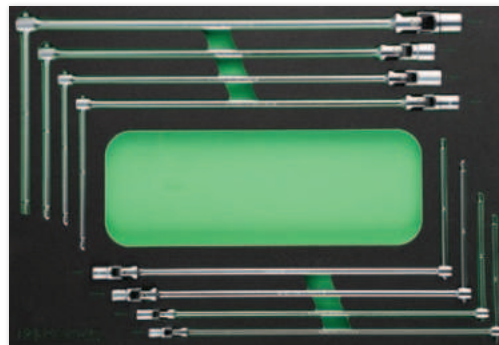

- FG 100/10C: Módulo 8 chaves em T hexagonais 7-19mm

**MAXI STATION FG 120
 COM UM SORTIDO
 DE 224 FERRAMENTAS**



Mobiliário para vans!

Oferecemos aos nossos clientes a mais alta qualidade e eficiência, mesmo na estrada. O mobiliário **Fasano Tools** para carrinhas e veículos comerciais oferece a possibilidade de criar o ambiente de trabalho ideal para as suas necessidades.

Totalmente personalizável e modular, é composto por gavetas, armários, prateleiras e paredes equipadas com grelhas de ferramentas, porta-peças e uma vasta gama de acessórios.

Tudo o que você precisa para trabalhar fora de sua própria oficina, mesmo que você sempre o carregue com você.

O mobiliário técnico Fasano Tools dedicado aos veículos equipados adapta-se perfeitamente a todas as necessidades do trabalho diário. Escolha a cor e a composição ideais!

MADE IN ITALY

Módulos disponíveis em 3 variantes de cores

RAL 6018

RAL 5002

RAL 3001



MÓDULOS

MOBILIÁRIO PARA VANS!



ALÇAS ABS COM ALÇA ERGONÓMICA

GAVETAS COM ABERTURA TOTAL PARA MÓDULOS PORTA-FERRAMENTAS

MALAS MODULARES COM COMPARTIMENTOS SUPORTE PARA PEÇAS PEQUENAS

PORTAS DE ABERTURA TOTALMENTE EXTRAÍVEIS

BANDEJAS PLÁSTICAS PARA PEÇAS PEQUENAS

PLATAFORMAS ANTIDERRAPANTE



FG 119V/C016

2.326,00

899,00€

CONFIGURAÇÃO DE MOBILIÁRIO TÉCNICO PARA VANS

Dimensões mm: 980x400x1057

Peso kg: 61,8

Inclui (de cima para baixo)

FG 119/MRT40-9: par de montantes laterais

FG 119/RP40-92: Prateleira com divisórias amovíveis

FG 119V/C49-3: Cómada de 3 gavetas

FG 119V/C49-4: Cómada de 4 gavetas

FG 119V/BA98: móvel inferior aberto

FG 119/RI98: extensão para armários inferiores abertos ou fechados

FG 119/KS: kit de instalação

MADE IN ITALY



FG 119V/C016



FG 119B/C016



FG 119R/C016



FG 119V/C012

2.869,00

1.199,00€

CONFIGURAÇÃO DE MOBILIÁRIO TÉCNICO PARA VANS

Dimensões mm: 980x400x1592

Peso kg: 74,9

Inclui (de cima para baixo)

FG 119/M30-40: par de montantes laterais

FG 119/RV30-92: Prateleira com tabuleiros de plástico

FG 119/RP30-92: prateleira com divisórias amovíveis

FG 119/M40-23: pares de montantes laterais

FG 119/RP40-92: Prateleira com divisórias amovíveis

FG 119V/C49-3: Cómada de 3 gavetas

FG 119V/C49-4: Cómada de 4 gavetas

FG 119V/BA98: móvel inferior aberto

FG 119/RI98: extensão para armários inferiores abertos ou fechados

FG 119/KS: kit de instalação

MADE IN ITALY



FG 119V/C012



FG 119B/C012



FG 119R/C012



MOBILIÁRIO PARA VANS



FG 119V/C025

2.241,00

949,00€

CONFIGURAÇÃO DE MOBILIÁRIO TÉCNICO PARA VANS

Dimensões mm: 1225x400x1057

Peso kg: 76,2

Inclui (de cima para baixo)

FG 119/MRT40-9: par de montantes laterais

FG 119/RP40-116: Prateleira com divisórias amovíveis

FG 119V/C49-4: Cómada de 4 gavetas

FG 119V/C73-3: gaveteiro com 3 gavetas

FG 119/BVF-L122B: base alta com abertura frontal

FG 119/KS: kit de instalação

MADE IN ITALY



FG 119V/C025



FG 119B/C025



FG 119R/C025



FG 119V/C022

2.794,00

1.199,00€

CONFIGURAÇÃO DE MOBILIÁRIO TÉCNICO PARA VANS

Dimensões mm: 1225x400x1592

Peso kg: 91,2

Inclui (de cima para baixo)

FG 119/M30-40: par de montantes laterais

FG 119/RV30-116: Prateleira com tabuleiros de plástico

FG 119/RP30-116: prateleira com divisórias amovíveis

FG 119/M40-23: pares de montantes laterais

FG 119/RP40-116: Prateleira com divisórias amovíveis

FG 119V/C49-4: Cómada de 4 gavetas

FG 119V/C73-3: gaveteiro com 3 gavetas

FG 119/BVF-L122B: base alta com abertura frontal

FG 119/KS: kit de instalação

MADE IN ITALY



FG 119V/C022



FG 119B/C022



FG 119R/C022

FG 119V/C033

4.077,00

1.599,00€

CONFIGURAÇÃO DE MOBILIÁRIO TÉCNICO PARA VANS

Dimensões mm: 1470x400x1360

Peso kg: 114

Inclui (de cima para baixo)

FG 119/M30-40: par de montantes laterais

FG 119/RP30-141: prateleira com divisórias amovíveis

FG 119/RV30-141: Prateleira com tabuleiros de plástico

FG 119V/C49-V1: módulo equipado com 4 caixas de peças pequenas

FG 119V/C98-3: Cómada de 3 gavetas

FG 119V/BA98: base aberta

FG 119V/C49-5B: móvel inferior com 5 gavetas

FG 119/RI98: base elevada para móveis abertos ou fechados

FG 119/KS: kit de instalação



MADE IN ITALY



FG 119V/C033



FG 119B/C033



FG 119R/C033

FG 119V/C036

3.567,00

1.599,00€

CONFIGURAÇÃO DE MOBILIÁRIO TÉCNICO PARA VANS

Dimensão mm (LxPxH): 1470x400x1057

Peso kg: 98,9

Inclui (de cima para baixo)

FG 119/MRT20-9 x 2: par de montantes laterais

FG 119/RP20-141 x 2: prateleira com divisórias amovíveis

FG 119M/C49-V2: módulo equipado com 4 caixas de peças pequenas

FG 119V/C98-3: Cómada de 3 gavetas

FG 119V/BA98: móvel inferior aberto

FG 119V/C49-5B: móvel inferior com 5 gavetas

FG 119/RI98: com elevação para armários inferiores abertos ou fechados

FG 119/KS: kit de instalação



MADE IN ITALY



FG 119V/C036



FG 119B/C036



FG 119R/C036



FG 119V/C018

~~2.375,00~~

999,00€

CONFIGURAÇÃO DE MOBILIÁRIO TÉCNICO PARA VANS

Dimensão mm (LxPxH): 980x400x980

Peso kg: 56,5

Inclui (de cima para baixo)

FG 119/98TL: bancada de madeira

FG 119/C49-3: Cómada de 3 gavetas

FG 119/C49-4: Cómada de 4 gavetas

FG 119V/BA98: móvel inferior aberto

FG 119/R198: elevação para armários inferiores abertos ou fechados

FG 119/KS: kit de instalação

MADE IN ITALY



FG 119V/C018



FG 119B/C018



FG 119R/C018

FG 119V/C027

~~2.390,00~~

1.099,00€

CONFIGURAÇÃO DE MOBILIÁRIO TÉCNICO PARA VANS

Dimensão mm (LxPxH): 1225x400x980

Peso kg: 71,6

Inclui (de cima para baixo)

FG 119/73TL: bancada de madeira

FG 119/49TL: bancada de madeira

FG 119/C49-4: Cómada de 4 gavetas

FG 119/C73-3: Cómada de 3 gavetas

FG 119/BVF-L122B: base alta com abertura frontal

FG 119/KS: kit de instalação



FG 119V/C027



FG 119B/C027



FG 119R/C027



FG 119M/C013

~~1.493,00~~

499,00€

CONFIGURAÇÃO DE MOBILIÁRIO TÉCNICO PARA VANS

Dimensão mm (LxPxH): 980x400x1592

Peso kg: 40,4

Inclui (de cima para baixo)

FG 119/M30-40: par de montantes laterais

FG 119/RP30-92: prateleira com divisórias amovíveis

FG 119/RP30-92: Prateleira com divisórias amovíveis

FG 119/M40-23: Pares de montantes laterais

FG 119/M40-40: Pares de montantes laterais

FG 119/RP40-92: Prateleira com divisórias amovíveis

FG 119/RP40-92: Prateleira com divisórias amovíveis

FG 119/BVF-L98B: base com abertura frontal

FG 119/KS: kit de instalação

MADE IN ITALY



FG 119M/C028

~~1.573,00~~

599,00€

CONFIGURAÇÃO DE MOBILIÁRIO TÉCNICO PARA VANS

Dimensão mm (LxPxH): 1225x400x1592

Peso kg: 40,4

Inclui (de cima para baixo)

FG 119/M30-40: par de montantes laterais

2 x FG 119/RP30-141: prateleiras com divisórias amovíveis

FG 119/M40-23: pares de montantes laterais

FG 119/M40-40: Pares de montantes laterais

2 x FG 119/RP40-141: prateleiras com divisórias amovíveis

FG 119/BVF-L147B: base com painel frontal amovível

FG 119/KS: kit de instalação

MADE IN ITALY



FG 119M/C037

~~1.739,00~~

699,00€

CONFIGURAÇÃO DE MOBILIÁRIO TÉCNICO PARA VANS

Dimensão mm (LxPxH): 1470x400x1592

Peso kg: 40,4

Inclui (de cima para baixo)

FG 119/M30-40: par de montantes laterais

2 x FG 119/RP30-116: prateleiras com divisórias amovíveis

FG 119/M40-23: pares de montantes laterais

FG 119/M40-40: pares de montantes laterais

2 x FG 119/RP40-116: prateleiras com divisórias amovíveis

FG 119/BVF-L122B: base com painel frontal amovível

FG 119/KS: kit de instalação

MADE IN ITALY



FERRAMENTAS ESPECIAIS PARA AUTOMOTIVE

FG 175/F074.5-8

~~50,00€~~

29,90€

CHAVE DE CAIXA PARA FILTROS DE ÓLEO FIAT, LANCIA, ALFA ROMEO
Ø/mm: 74.5 - 8 lados



1/2"

FG 175/F084

~~57,00€~~

33,90€

CHAVES PARA FILTRO DE ÓLEO MERCEDES
Ø/mm: 84 - 14 lados



1/2"

FG 175/HI

~~67,00€~~

39,90€

CHAVES PARA FILTRO DE ÓLEO- HYUNDAI TUCSON
Ø/mm: 81 - 14 lados



1/2"

FG 175/OP1

~~46,50€~~

27,90€

CHAVE DE FILTRO DE ÓLEO OPEL/VAUXHALL
Ø/mm: 74.7 - 15 lados



1/2"

FG 175/S30

~~221,50€~~

129,00€

JOGO 28 CHAVES PARA FILTRO DE ÓLEO



FG 175/S6

~~63,00€~~

39,90€

JOGO DE 6 CHAVES PARA CARTUCHOS DE FILTRO
Conteúdo: 6pz



FG 178/UF83

~~35,00€~~

20,90€

CHAVE DE APERTO AUTOMÁTICO PARA REMOVER FILTROS DE ÓLEO

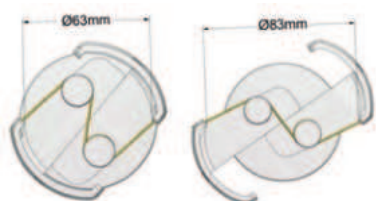

NEW



CHAVE DE FILTRO DE ÓLEO PARA APERTAR COM A MÃO DIREITA E ESQUERDA - MODELO PARA SERVIÇO PESADO

1/2"



CÓDIGO	ØMM	€/LISTA	€/PROMO
FG 178/UF110	80 - 110 mm	115,00€	69,00€
FG 178/UF145	104 - 145 mm	165,00€	99,00€

FG 178/FL

~~46,00€~~

28,90€

FUNIL FLEXÍVEL DE ALUMÍNIO REVESTIDO A BORRACHA



NEW



FG 175/PR

~~40,00€~~

23,90€

EXTENSÃO PARA CHAVES DE CAIXA PARA REMOÇÃO DE TAMPA DE ÓLEO

Com recipiente de óleo



NEW



FG 175/S15

~~135,00€~~

79,90€

JOGO 15 CHAVES MAGNÉTICAS PARA BUJÕES DE ÓLEO



FG 175/S114

~~265,00€~~

159,00€

FERRAMENTAS PARA REPARAÇÃO BUJÕES DE ÓLEO

- M 13x1.25
- M 13x1.5
- M 15x1.5
- M 17x1.5
- M 20x1.5
- M 22x1.5





FG 203/S20

~~370,00€~~

209,00€

KIT PARA DETECÇÃO DE FUGAS E ENCHIMENTO RÁPIDO DE SISTEMAS DE REFRIGERAÇÃO



FG 201/S7

~~340,00€~~

209,00€

KIT PARA PRESSÃO NA SISTEMAS DE CIRCUITO DIESEL

Novo modelo com bomba bidirecional



FG 176/S13

~~445,00€~~

259,00€

APARELHO PARA O ENCHIMENTO DE ÓLEO NAS CAIXAS DE VELOCIDADES, TRANSMISSÕES, DIFERENCIAIS

Equipado com 12 acessórios para ligação direta
Equipado com válvula anti-retorno



TAMPAS OPCIONAIS PARA FG 203/S20

FG 203/BW1
BMWFG 203/FO1
FORD Fiesta
from 2008FG 203/FO2
FORDFG 203/OP1
OPELFG 203/TO1
TOYOTAFG 203/FT1
FIAT

CÓDIGO	MARCAS	€/LISTA	€/PROMO
FG 203/BW1	BMW	36,50€	21,90€
FG 203/FO1	FORD FIESTA DAL 2008	36,50€	21,90€
FG 203/FO2	FORD	36,50€	21,90€
FG 203/FT1	FIAT	45,00€	26,90€
FG 203/OP1	OPEL	36,50€	21,90€
FG 203/TO1	TOYOTA	37,50€	22,90€

FG 203/S7

~~166,00€~~

99,00€

FERRAMENTA PARA O PREENCHIMENTO DE DEPRESSÃO DOS CIRCUITOS DE REFRIGERAÇÃO

Útil para uma purga perfeita devido à aspiração do circuito de arrefecimento



FG 491/200

~~38,00€~~

23,90€

SERINGA PARA FLUIDOS

Fornecido com 2 vedantes de substituição - Capacità 200cc

FG 491/1500

~~85,00€~~

51,90€

SERINGA PARA ÓLEO

Fornecido com 2 vedantes de substituição

Não adequado para combustíveis e óleos minerais - Capacità 1500cc



FG 491/DF1500

~~135,00€~~

79,90€

SERINGA DE EXTRAÇÃO DE COMBUSTÍVEL DO CIRCUITO DIESEL

Equipadas com adaptadores de ligação rápida - Capacità 1500cc



FG 191/S22

620,00€

389,00€

EXTRACTOR UNIVERSAL PARA INJECTORES ELÉCTRICOS DEPLHI, BOSCH SIEMENS E DENSO

Completo com martelo massa 4,8 kg

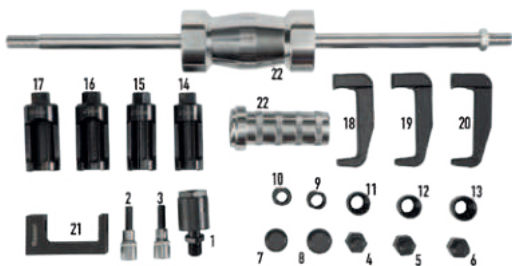
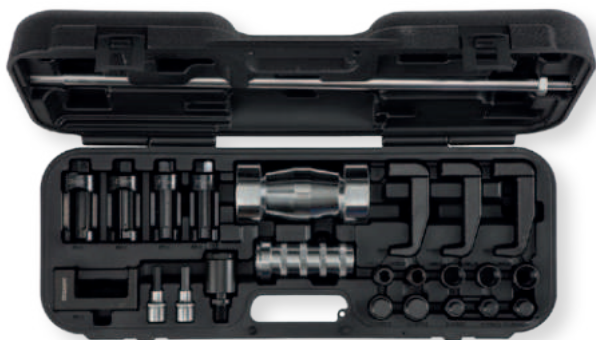

CÓDIGO	DESCRIÇÃO
FG 191/ES-SN	1- Junta de articulação universal
FG 190/EL1A	2- Ferramenta de remoção de eléctrodos electro-injectores Ø 7,5
FG 190/EL1	3- Ferramenta de remoção de eléctrodos injectores Ø 6,6
FG 191/ES-6	4- Adaptador com rosca exterior M16X1,0
FG 191/ES-7	5- Adaptador com rosca exterior M17X1
FG 191/ES-8	6- Adaptador com rosca exterior M20X1
FG 191/ES-9	7- Adaptador com rosca exterior M25X1
FG 191/ES-10	8- Adaptador com rosca externa M27X1
FG 191/ES-2	9- Adaptador com rosca interna M16X1.5
FG 191/ES-1	10- Adaptador com rosca interna M14X1.5
FG 191/ES-3	11- Adaptador com rosca interna M25X0.5
FG 191/ES-4	12- Adaptador com rosca interna M25X0,75
FG 191/ES-5	13- Adaptador com rosca interna M27X1,0
FG 190/A25	14- Casquilho para retirar a ligação eléctrica Ø 25
FG 190/A27	15- Tomada para retirar a ligação eléctrica Ø 27
FG 190/A29	16- Tomada para a remoção da ligação eléctrica Ø 29
FG 190/A30	17- Tomada para a remoção da ligação eléctrica Ø 30
FG 191/ES-11	18- Abertura do extrator de garfos 12 mm
FG 191/ES-12	19- Abertura do extrator de garfos 13,5 mm
FG 191/ES-13	20- Abertura do extrator de garfos 16 mm
FG 191/ES-14	21- Abertura do extrator de garfos 26 mm
FG 191/MI	22- Massa da alavanca 4,8 kg

FG 191/S24

470,00€

299,00€

JOGO DE FERRAMENTAS DE EXTRAÇÃO PNEUMÁTICA PARA ELECTRO-INJECTORES BOSCH, DELPHI, SIEMENS E DENSO

NEW



CÓDIGO	DESCRIÇÃO
FG 191/S24-1	1-Extrator
FG 191/S24-2	2-Adptador M14*1.5xM18*1.5x52L
FG 191/S24-4	4-Adptador M18*0.75xM14x66
FG 191/S24-5	5-Adptador M17*1.0xM14x66L
FG 191/S24-6	6-Adptador M10*1.5xM14x33L
FG 191/S24-7	7-Adptador M8*1.0xM14x33L
FG 191/S24-8	8-Adptador M8*1.5xM14x33L
FG 191/S24-9	9-Adptador M22*1.5xM14x33L
FG 191/S24-10	10-Adptador M20*1.5-M12*1.5(Interno)xM14x33L
FG 191/S24-11	11-Adptador M14*1.5x33L
FG 191/S24-12	12-Adptador M16*1.5xM14x33L
FG 191/S24-13	13-Adptador M18*1.5xM14 x33L
FG 191/S24-14	14-Adptador M31*0.75xM14x62L
FG 191/S24-15	15-Adptador M26*0.75xM14x62L
FG 191/S24-16	16-Adptador M27*1.0xM14x45L
FG 191/S24-17	17-Adptador M27*0.75xM14x45L
FG 191/S24-18	18-Adptador M25*1.0xM14x45L
FG 191/S24-19	19-Adptador M25*0.5xM14x45L
FG 191/S24-20	20-Adptador M29*1.0xM14x45L
FG 191/S24-3	3-Adptador M20*1.0xM14 x66L



FG 191/S14

~~150,00€~~

89,00€

KIT DE LIMPEZA DO ASSENTO DO INJETOR

No caso do ABS



CÓDIGO	DESCRIÇÃO
FG 191/S14-2	1- Haste roscada M5X0.8XL200mm
FG 191/S14-3	2- Tampa de fecho do assento do injetor
FG 191/S14-4	3- Escova longa para limpeza da sede do injetor
FG 191/S14-1	4- Extensão flexível
FG 191/S14-6	5- Escova para copos Ø 15
FG 191/S14-7	6- Escova para copos Ø 20
FG 191/S14-8	7- Escova Ø 24x85L
FG 191/S14-9	8- Escova Ø 18x85L
FG 191/S14-10	9- Escova Ø 21x85L

FG 190/S6B

~~165,00€~~

99,00€

JOGO PARA LIMPEZA LOCAIS INJETORES

No caso do ABS



FG 175/FT2

~~82,50€~~

49,90€

CHAVE PARA BÓIAS DO RESERVATÓRIO DE COMBUSTÍVEL

Para molduras de plástico Citroën e Peugeot
L/mm 157

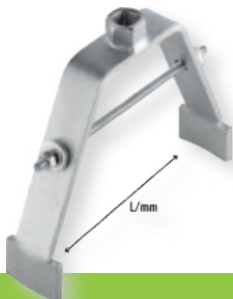

FG 175/FT4

~~72,50€~~

42,90€

CHAVE PARA BÓIAS DO RESERVATÓRIO DE COMBUSTÍVEL

Para virolas de plástico Grupo VAG
L/mm 180



FG 175/FT1

~~67,00€~~

39,90€

CHAVE PARA BÓIAS DO RESERVATÓRIO DE COMBUSTÍVEL

Para virolas de alumínio Fiat, VW, Opel, Mercedes, BMW
L/mm 170

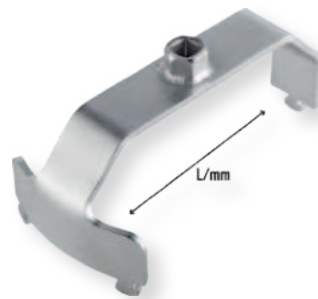

FG 175/FT3

~~85,00€~~

51,90€

CHAVE PARA BÓIAS DO RESERVATÓRIO DE COMBUSTÍVEL

Para lunetas de plástico FCA (Fiat Freemont, 500L, 500X, Jeep Renegade, etc.)
L/mm 145

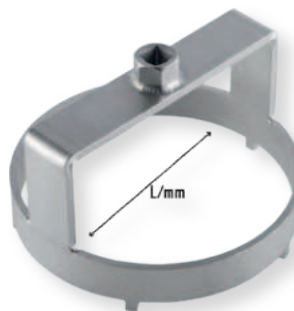

FG 175/FT5

~~72,50€~~

42,90€

CHAVE PARA BÓIAS DO RESERVATÓRIO DE COMBUSTÍVEL

Para molduras de alumínio Grupo OPEL



FG 174/F2

~~72,50€~~

43,50€

CHAVE PARA BÓIAS DO RESERVATÓRIO DE COMBUSTÍVEL GRUPO FCA
L/MM 130

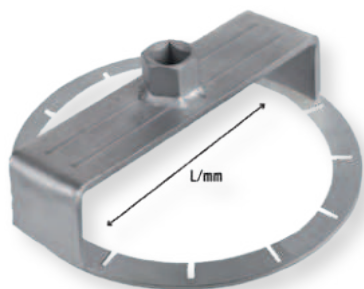

FG 174/SC

~~118,50€~~

74,90€

CHAVE REGULÁVEL PARA BÓIAS DO RESERVATÓRIO DE COMBUSTÍVEL
Ømm: 88-170



FG 182/S16

~~530,00€~~

319,00€

JOGO FERRAMENTAS REMOÇÃO VELAS DE INCANDESCÊNCIA

No caso do ABS



Brocas de titânio



Cone/Extrator de centragem em aço

FG 183/S5

~~113,50€~~

69,00€

JOGO 5 CHAVES PARA VELAS INCANDESCÊNCIA DE MOTOR DIESEL
Conteúdo: 8,9,10,12,14mm



FG 189/S13

~~250,00€~~

159,00€

TESTER ESPECIAL PARA CONTROLE DO SISTEMA TURBO

Utilizado para verificar a estanquicidade do sistema de combustível desde o coletor de admissão até ao rolo do compressor



FG 179/S16

~~160,00€~~

89,00€

JOGO CHAVES PARA POLIAS DE ALTERNADOR





FG 178/SF

~~1.820,00€~~

899,00€

EXTRACTOR LÍQUIDO DOS TRAVÕES

Fonte de alimentação de 12V com cabos de bateria
Equipado com compartimento de arrumação traseiro e recipiente de recuperação de óleo
Equipado com sensor de fim de líquido
Pressão regulável até 2 bar
Caixa em aço inoxidável



42 mm



44, 45, 46mm

2 tampas na caixa

FG 180/S12

~~85,00€~~

51,90€

JOGO PARA EMBRAIAGENS

Cones de centragem Ø 12-20mm



FG 180/S17

~~350,00€~~

199,00€

KIT PARA AJUSTE DA EMBREAGEM DUPLA (DMF)

FG 178SF/AD13

~~60,00€~~

35,90€

TAPPI OPTIONAL SPECIFICI PER MOTORI FORD

Fiesta 2011-2016

FG 178SF/AD14

~~60,00€~~

35,90€

TAPPI OPTIONAL SPECIFICI PER MOTORI FORD

Mondeo dal 2014 - Fiesta dal 2016 - Mazda CX3/CX5 2011-2016

FG 178SF/AD13
(Fiesta 2011-2016)FG 178SF/AD14
(Mondeo dal 2014, Fiesta dal 2016
Mazda CX3/CX5)

FG 180/S38

~~700,00€~~

419,00€

JOGO PARA EMBRAIAGENS SAC

FG 178/S6

~~330,00€~~

189,00€

JOGO DE FICHAS PARA VEÍCULOS ASIÁTICOS

Toyota, Hyundai, Nissan, Mitsubishi, Mazda, Subaru, Honda, Suzuki



FG 178/BF

255,00€

149,00€

EXTRACTOR DE LÍQUIDO DE TRAVÕES

Equipado com sondas e ligações universais



FG 199/PF

230,00€

139,00€

KIT PNEUMÁTICO PARA OS ÊBOLOS DOS DISCOS DOS TRAVÕES

Para destros e canhotos



FG 628/S7

115,00€

69,00€

JOGO 3 CHAVES PARA JANTES DE LIGA LEVE COM ADAPTADORES PARA PARAFUSOS DANIFICADOS

17, 19, 21mm

1/2"



FG 199/SF

60,00€

37,90€

SERINGA DE EXTRAÇÃO DE ÓLEO DO CIRCUITO DE FREIO

Equipado com ligações específicas para os acessórios do circuito de travagem

Junta interna de VITON

Capacità 200cc



FG 198/S11

138,00€

82,90€

KIT DE DESMONTAGEM PARAFUSOS PINÇA DE FREIO

BMW, Ford, VAG, Mercedes



FG 125/LV

20,00€

11,90€

GANCHO DE ALAVANCA UNIVERSAL PARA EIXOS

Para montagem e desmontagem simples e segura de peças de veio.

Graças ao seu design especial pode ser colocado muito próximo da suspensão.

NEW





FG 168/GA

~~60,00€~~

37,90€

FERRAMENTA UNIVERSAL DE ESPALHAMENTO

Elevada capacidade
Utilização universal
Superfícies de pressão paralelas
Capacidade 5 - 11,5 mm



FG 165/S26

~~720,00€~~

459,00€

JOGO DE FERRAMENTAS PARA EXTRACÇÃO E COLOCAÇÃO DE SILENT BLOCK

Bujes para Ø 44-82mm
4 varillas roscadas M10, M12, M14, M16



FG 166/S7

~~520,00€~~

329,00€

JOGO EXTRACTORES ANÉIS DE ROLAMENTOS

Pinças: Ø 40-45mm, 45-51mm, 50-55mm, 55-61mm
Chaves de porcas: Ø 82,7mm, 58,9mm



FG 168/S7

~~265,00€~~

169,00€

EXTRATOR EM FORMA DE C PARA CASQUILHOS E ROLAMENTOS

Construção robusta com estrutura em aço
Com adaptadores para ligações de 1/4", 3/8", 1/2", 3/4" para utilização em automóveis, carrinhas e veículos comerciais
Parafuso mm 165 - H/mm 89

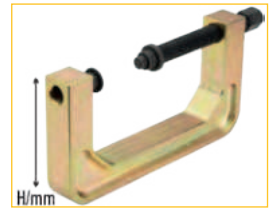

FG 159/PM

~~230,00€~~

139,00€

COMPRESSORES DE AMORTECEDORES

Equipado com 2 pares de hastes roscadas



FG 166/S28

~~475,00€~~

299,00€

FERRAMENTAS PARA EXTRACÇÃO E COLOCAÇÃO OLAMENTOS DE RODAS

Desmontagem Ø 34-45mm
Montagem Ø 60-84mm

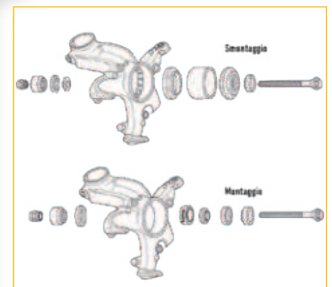

FG 98/A1

~~66,00€~~

41,90€

CARREGADOR DE BATERIAS E MANTENEDOR DE CARGA 6/12V

Pode ser utilizado com todos os tipos de baterias, tanto de chumbo-ácido como de lítio
Indicador do nível de carga
Proteção contra sobreaquecimento, inversão de polaridade, curto-circuito
Fornecido com cabo com alicate e cabo com ilhós
Tamanho 71x116 - Peso 170gr



FG 98/A6

~~120,00€~~

75,00€

CARREGADOR DE BATERIAS E MANTENEDOR DE CARGA 6/12V

Pode ser utilizado com todos os tipos de baterias, tanto de chumbo-ácido como de lítio
Ecrã LCD
Função WINTER (ciclo de carga otimizado a baixas temperaturas)
Indicador do nível de carga
Identificação das pilhas gastas
Proteção contra sobreaquecimento, inversão de polaridade, curto-circuito
Fornecido com cabo com alicate e cabo com ilhós
Tamanho 200x76 mm - Peso 460gr



FG 98/A15

~~280,00€~~

179,00€

CARREGADOR DE BATERIAS E MANTENEDOR DE CARGA 6/12/24V

Pode ser utilizado com todos os tipos de baterias, tanto de chumbo-ácido como de lítio
Ecrã LCD
8 níveis de carga
Função WINTER (ciclo de carga otimizado a baixas temperaturas)
Função JUMP (carregamento para baterias muito fracas)
Indicador do nível de carga
Identificação das pilhas gastas
Função de recuperação de bateria fraca para baterias de chumbo-ácido
Proteção contra sobreaquecimento, inversão de polaridade, curto-circuito
Cabo com pinças incluído
Tamanho 200x120 mm - Peso 1300gr



FG 97/LT

~~250,00€~~

149,00€

ARRANCADOR PORTÁTIL MULTI-FUNÇÕES

Adequado para o arranque de emergência de motores com bateria de 12V
Ecrã LCD
2 saídas USB 5V 2.4A
Cabo 12V 10A para tomada de isqueiro incluído
Led com 5 modos
3 modos de carregamento (incluído: carregador, cabo USB tipo C, adaptador 14V 1A para tomada de isqueiro)
Função Power Bank
Função Travel Lock
Fornecido com o boost com pinças de arranque do motor, caixa



FG 220/BT

~~420,00€~~

249,00€

TESTER DIGITAL PARA BATERIAS 12V E 24V

Tensão de funcionamento: 9V a 35V DC
Tempo de verificação da bateria: aprox. 1 minuto
Pilha interna para a memória data/hora: CR1220 (1 unidade)
Medidas mm 90x50x235



CARACTERÍSTICAS:	DISPLAY ILUMINADO
	SOFTWARE 6 LINGUAS: italiano; ingles; espanhol; polaco; alemão; francês
	IMPRESSORA INTEGRADA COM ROLO DE PAPEL TÉRMICO
	SISTEMA DE DETECÇÃO FALSA CONTACTO COM PINÇA
APLICAÇÃO:	TESTE DE BATERIA 12 E 24V
	TEST E DE ALTERADOR (INTELIGENTE E NORMAL) 12-24V CARGA
	TESTE DE SISTEMA DE ARRANQUE
SUPORTA BATERIAS DE:	PB, WET, GEL AGM, AGM FLAT, EFB
NORMAS:	CCA: 100-1700; IEC: 100-1000; EN: 100-1700; DIN: 100-1000; JIS
COMPRIMENTO DO CABO:	570 mm



FG 172/FA2

~~85,00€~~

53,90€

ALICATE DE CATRACA PARA GRAMPOS DE MANGA

Função de aperto com roquete
Abertura com mecanismo de mola



FG 172/AS2

~~113,00€~~

69,90€

**ALICATE COM EXTENSÃO PARA ABRAÇADEIRAS
COM EXTENSÃO INTERCAMBIÁVEL**

Abertura mm 3-52



FG 172/FA

~~72,50€~~

39,90€

ALICATE UNIVERSAL PARA ABRAÇADEIRAS



FG 172/TC

~~35,00€~~

19,90€

ALICATES PARA REMOVER PINOS DE CORRENTE



FG 172/PA

~~70,00€~~

42,90€

ALICATE PARA ABRAÇADEIRAS EM AÇO INOX

Também adequado para braçadeiras de cabos Panduit
Ømm 4.7 - 9.5



FG 172/TG

~~49,50€~~

23,90€

ALICATE PARA TUBOS DE ÁGUA E COMBUSTÍVEL



FG 172/MA

~~98,00€~~

59,90€

ALICATE DE PRESSÃO

Com mordentes ajustáveis multi-grip

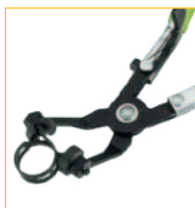

FG 181/PM2

~~93,00€~~

49,00€

EXTRACTOR UNIVERSAL DE POLIAS



FG 171/B

~~47,00€~~

28,90€

ALICATE DE LIGAÇÕES RÁPIDAS COMBUSTÍVEL



FG 172/G02

~~110,00€~~

62,90€

ALICATE PARA ABRAÇADEIRA OETIKER

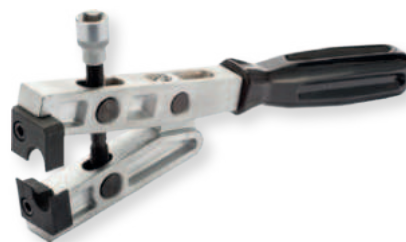

3/8"



FG 198/PE

~~60,00€~~

37,90€

ALICATE DE REMOÇÃO DE PESOS DE EQUILÍBRIO DAS RODAS



FG 172/OT

~~56,00€~~

33,90€

ALICATE PARA ABRAÇADEIRA OETIKER



FG 184/S5

~~162,00€~~

99,00€

JOGO DE 5 CHAVES DE PORCA DO TENSOR DA CORREIA
13,15,16,17,19mm



FG 172/S4

~~50,00€~~

19,90€

ADAPTADORES PARA REMOÇÃO DE UNIÕES DE FILTROS DIESEL



FG 171/FL

~~51,50€~~

29,90€

ALICATE GIRATÓRIO DE ENGATE RÁPIDO PARA TUBOS DE COMBUSTÍVEL, COM MANDÍBULAS ARTICULADAS



FG 172/CA

~~58,00€~~

34,90€

ALICATE PARA CACHIMBO DE VELA

Ømm: 14
L/mm: 290





FG 215/S40

1.550,00€

899,00€



TESTER DIGITAL PARA COMPRESSÃO DO MOTOR COMPLETO COM INJETORES E VELAS DE INCANDESCÊNCIA FALSAS PARA SISTEMAS DIESEL

MADE IN ITALY



ACESSÓRIOS INCLuíDOS:



TEST ALTERNADOR



TEST COMPRESSÃO

MADE IN ITALY



FG 219/S

3.350,00€

1999,00€



TESTER DIGITAL PARA COMPRESSÃO DO MOTOR, PRESSÃO DE COMBUSTÍVEL E PRESSÃO DO ÓLEO DO MOTOR

CARACTERÍSTICAS TÉCNICAS:

- PRECISÃO: 1%FS
- SOFTWARE EM 8 LÍNGUAS (IT, EN, DE, FR, ES, PT, GR, PL)
- ECRÃ LCD TOUCH SCREEN, 4.3"
- SENSOR 0-80 BAR E 0-2.500 BAR



TEST ALTERNADOR
TEST COMPRESSÃO DO MOTOR
TEST TENSÃO DE BATERIA



TEST COMPRESSÃO



TEST PRESSÃO COMBUSTÍVEL



TEST PRESSÃO ÓLEO DO MOTOR

FG 193DSG/S9

~~1.050,00€~~

629,00€

KIT PARA MONTAJE, DESMONTAJE Y REGISTRO EMBRAGUES DSG 7 VELOCIDADES

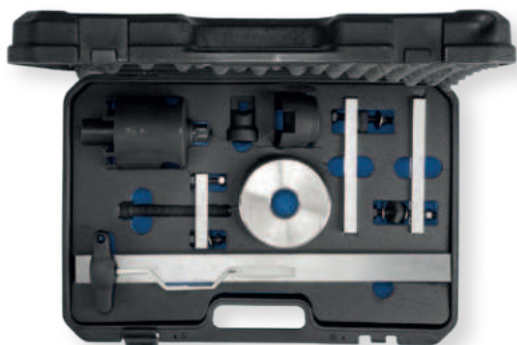

FG 193/S4

~~500,00€~~

299,00€

KIT EXTRATOR DE ROLAMENTOS DA CAIXA MANUAL VAG

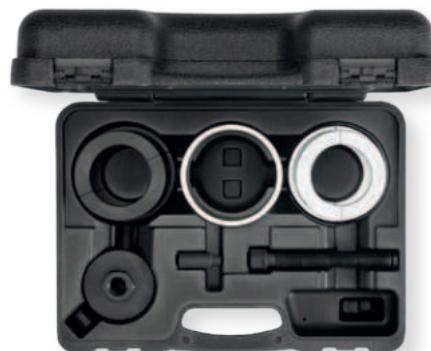

FG 193/DCT

~~160,00€~~

99,00€

FERRAMENTA PARA GRUPO EMBRAIAGEM DCT

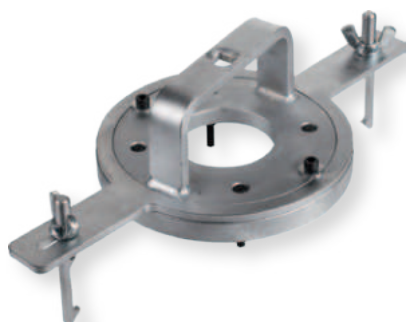

FG 194/TS

~~35,00€~~

21,90€

FERRAMENTA PARA CAIXA AUTOMÁTICA DSG COM DUPLA EMBRAIAGEM



FG 193/ATJ

~~45,00€~~

26,90€

FERRAMENTA PARA DESMONTAGEM TAMPA DE ÓLEO DA CAIXA AUTOMÁTICA



HASTES DE NÍVEL DE ÓLEO PARA CAIXAS AUTOMÁTICAS

Aplicações: Mercedes 722.6



FG 193/MB

~~65,00€~~

39,00€

FERRAMENTA DE MEDIÇÃO E DRENO ÓLEO DA CAIXA AUTOMÁTICA



CÓDIGO	€/LISTA	€/PROMO
FG 193/DS1	35,00€	19,90€
FG 193/DS2	35,00€	19,90€



SETOR DA CARROCERIA

Ferramentas de alto desempenho caracterizadas por detalhes dedicados à eficiência.

A nossa vasta e completa gama de ferramentas de carroçaria é dedicada ao trabalho de precisão e inclui kits de punção, juegos de raspadores, alavancas, facas, guias de arame, punhos, cunhas, saca-pinos, alicates, alavancas, alavancas de mola, ventosas, ferramentas dedicadas à remoção de farpas, ventosas e todas as ferramentas essenciais para os profissionais do setor.

Descubra todos na seção
AUTOMOTIVE



VENTOSA EQUIPADO DE ADERÊNCIA E SISTEMA BOMBEANDO



FERRAMENTA DE REMOÇÃO PARA JUNTAS DE VIDRO



FERRAMENTA DE REMOÇÃO DE LASCAS



KIT 4 MINI VENTOSAS PARA JANELAS DE CARRO



RASPADOR MANUAL COM LÂMINA RETA



KIT DE 6 VENTOSAS SIMPLES

FG 130AL/S5

~~37,50€~~

22,90€

JOGO DE PUNÇÕES DE PLÁSTICO E PUNÇÃO DE ALUMÍNIO

1 broca de alumínio ajustável 70mm-100mm

Rosca M8x1,25

4 punções de borracha dura, resistente a impactos e a riscos



FG 184/R2

~~23,00€~~

13,90€

RASPADOR DE AÇO COM PROTEÇÃO EM PVC E CABO EM ABS

L1/mm 275

L2/mm: 25,6

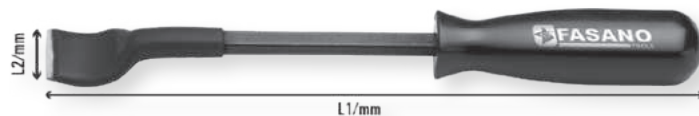

FG 184P/S3

~~26,00€~~

15,90€

JOGO DE 3 RASPADORES DE PLÁSTICO

Material: polipropileno de alta resistência



FG 186/S11

~~118,50€~~

69,00€

JOGO 11 FERRAMENTAS EM NYLON PARA CARROÇARIAS



FG 184/R1

~~21,00€~~

12,90€

RASPADOR DE AÇO COM CABO DE ABS

L1/mm 280

L2/mm: 19



FG 188P/S2

~~41,50€~~

24,90€

KIT DE CUNHA PARA REMOÇÃO DE MOLDURAS DE PLÁSTICO

Material: polipropileno de alta resistência

1 unidade com pega resistente à percussão

1 unidade sem pega, ideal para espaços reduzidos



FG 184R/S3

~~46,50€~~

27,90€

JOGO DE 3 RASPADORES DE AÇO COM CABO DE ABS

L1/mm 280

L2/mm: 10,8 - 25 - 40

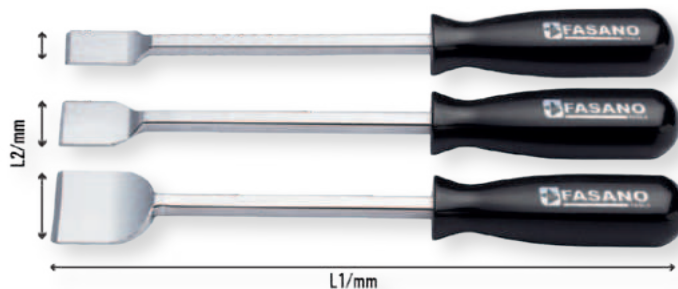



FG 188/P1

~~19,50€~~

11,90€

ALAVANCA PARA PEÇAS PLÁSTICAS

Material: Nylon e fibra de vidro
Elevada resistência à torção
Equipado com orifício para pendurar



FG 185P/S4

~~27,50€~~

16,90€

KIT DE 4 ALAVANCAS PARA PEÇAS PLÁSTICAS

Material: Nylon e fibra de vidro
Elevada resistência à torção
Equipado com orifício para pendurar

**KIT DE 3 ALAVANCAS DE PLÁSTICO**

CÓDIGO	€/LISTA	€/PROMO
FG 186/S3	12,00€	6,90€
FG 186/S3B	12,00€	6,90€

FG 186P/S5

~~37,50€~~

19,90€

JOGO 5 EXTRACTORES DE CAVILHAS DE NYLON

FG 185/S5

~~98,00€~~

59,00€

JUEGO DE 5 EXTRACTORES DE CAVILHAS COM CABO DE ABS

Conteúdo: FG 185/A1, FG 185/A2, FG 185/A6,
FG 185/A7, FG 185/A8



FG 186/AL1

~~25,00€~~

14,90€

ALAVANCA METÁLICA EXTRA PLANA

Design único da lâmina com um lado curvo e outro reto para remover fixadores internos e externos mesmo nos espaços mais apertados
Ponta fina e de alta resistência



FG 186/S5

~~98,00€~~

58,90€

JOGO DE 5 EXTRACTOR DE CAVILHAS, LÂMINA DE AÇO INOXIDÁVEL

FG 185B/S2

~~41,50€~~

24,90€

JUEGO DE 2 EXTRACTORES DE CAVILHAS COM CABO DE ABS

FG 186/S4

~~26,00€~~

15,90€

JOGO DE 4 GANCHOS COM LÂMINA DE AÇO

Com pega bimatéria



FG 185/RM

~~31,00€~~

18,90€

FERRAMENTA DE REMOÇÃO DE PEGA DE APOIO DE MÃO - GRUPO VAG

Pega em ABS
L/mm 255



FG 185/CR

~~10,50€~~

5,90€

FERRAMENTA DE REMOÇÃO DE MOLA

Ideal para retirar as molas C das manivelas das janelas



FG 185/OM

~~30,00€~~

18,90€

FERRAMENTA DE REMOÇÃO DO CLIP OMEGA

Para Grupo VAG, Tesla, Mercedes-Benz (2008 ~ 2020)

Utilizável também para remover cliques semelhantes ao revestimento da bagagem Tesla (Modelo Y) e ao revestimento da porta Tesla (Modelo Y)



NEW

FG 189/P01

~~21,00€~~

12,90€

FERRAMENTA DE REMOÇÃO DO CILINDRO DE TRAVAMENTO DA PORTA - GRUPO VAG



FG 189/P02

~~40,00€~~

23,90€

FERRAMENTA DE REMOÇÃO DO CILINDRO DE FECHO DAS PORTAS - VAG GROUP



FERRAMENTA DE REMOÇÃO DE FARPAS

Ideal para a limpeza do canal da janela

Ponta esférica para evitar danificar as calhas das portas



FG 183/RV1

~~21,00€~~

12,90€

FERRAMENTA DE REMOÇÃO DE VEDAÇÃO DE VIDRO

Pega em ABS
L/mm 255



CÓDIGO	L/MM	€/LISTA	€/PROMO
FG 182/RG10	255	19,50€	11,90€
FG 182/RG24	320	26,00€	15,90€



FG 183/CM

~~51,50€~~

29,90€

FACA MANUAL EQUIPADA COM CABO E SISTEMA DE PARADA DE CABO

Cabo e pega revestidos a PVC
Fornecida com lâmina de 25 mm já montada



FG 183/RA1

~~26,00€~~

15,90€

RASPADOR MANUAL DE LÂMINA RETA

Fornecido com um cabo ABS de uma lâmina com orifício para pendurar
Equipado com proteção da lâmina em ABS

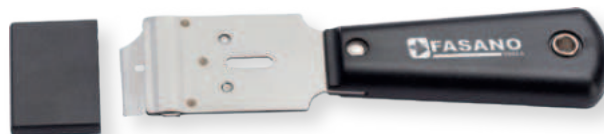

FACA DE CORTE

Fornecido com cabo revestido a PVC de uma lâmina
Sistema de bloqueio da lâmina com parafuso



CÓDIGO	L/MM	€/LISTA	€/PROMO
FG 183/CK250	250	22,00€	12,90€
FG 183/CK450	450	33,00€	19,90€
FG 183/CK600	600	41,50€	25,90€

FG 187/GU

~~29,50€~~

17,90€

ALAVANCA PARA VIDROS

L1/mm: 345 - L2/mm: 145



FG 187/GU2

~~27,50€~~

16,90€

GUIA DE OS COM CABO EM T EM ABS

L/mm: 320



FG 187/S7

~~220,00€~~

139,00€

FERRAMENTAS PARA VIDROS DE VIATURAS



FG 187/K25

~~46,00€~~

28,90€

VENTOSA SIMPLES

L/mm: 117
Capacidade kg: 25



FG 187/S2

~~720,00€~~

439,00€

CONJUNTO DE REMOÇÃO DO PARA-BRISAS COM SISTEMA DE VENTOSA DE ROQUETE

Com caixa de ABS



FG 188P/S4

~~68,00€~~

42,90€

CONJUNTO DE PROTEÇÃO DO PAINEL DE INSTRUMENTOS COM PEGA



FG 187/K40

~~196,00€~~

119,00€

VENTOSA SIMPLE COM ALÇA E SISTEMA DE BOMBEAMENTO

Capacidade 40Kg

Diâmetro: 178mm - 7"



FG 165/BC1

~~45,50€~~

28,90€

EXTRACTOR BRAÇO LIMPA PÁRA-BRISAS

Ø/mm: 30-50

L/mm: 42



FG 187/K30

~~72,50€~~

43,90€

VENTOSA DUPLA

L1/mm: 117

L2/mm: 380

Capacidade kg: 30



FG 165/BC3

~~68,00€~~

42,90€

EXTRACTOR AJUSTÁVEL PARA BRAÇOS DO LIMPA PARA-BRISAS BMW

Max Ø/mm: 37,5

L/mm: 64

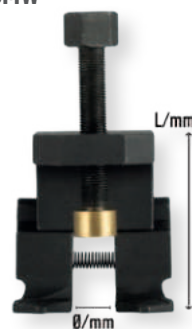

FG 187/PN

~~265,00€~~

169,00€

JOGO DE REPARAÇÃO MOSSAS, COM 3 VENTOSAS



FG 165BC/S6

~~230,00€~~

139,00€

JOGO DE 6 EXTRACTORES PARA BRAÇOS DO LIMPA PARA-BRISAS

1: VW, Porsche; 2: Ford, Seat, Mercedes; 3: BMW, VW; 4: Audi

A3-A4-A5-A6; 5: VW, Opel, Honda; 6: Audi Q7





PROFESSIONAL EQUIPMENT

PREGUIÇAS PARA VEÍCULOS



CE

CÓDIGO	CAPACITÀ KG	H-MIN/MAX MM	€/LISTA	€/PROMO
FG 725/3T	3000	285-425	100,00€	55,90€
FG 725/6T	6000	390-605	170,00€	95,00€
FG 725/12T	12000	495-720	300,00€	169,00€

FG 750/A

~~430,00€~~

249,00€

ELEVADOR PARA RODAS DE VEÍCULOS

Capacidade 680 kg
L1/mm: 550 - L2/mm: 620
Sistema de elevação a pedal
Equipado com 4 rodas giratórias



CE

MACACOS DE GARRAFA HIDRÁULICOS



CE

CÓDIGO	CAPACITÀ KG	H-MIN/MAX MM	€/LISTA	€/PROMO
FG 735/4T	4000	193-373	85,00€	49,00€
FG 735/6T	6000	210-416	98,00€	55,00€
FG 735/10T	10000	230-460	142,00€	79,00€
FG 735/16T	16000	230-440	168,00€	89,00€
FG 735/20T	20000	242-452	210,00€	109,00€

FG 748/0.5T

~~250,00€~~

139,00€

SUPORTE PARA MOTORES

Capacidade kg: 500Kg
L/mm: 1550

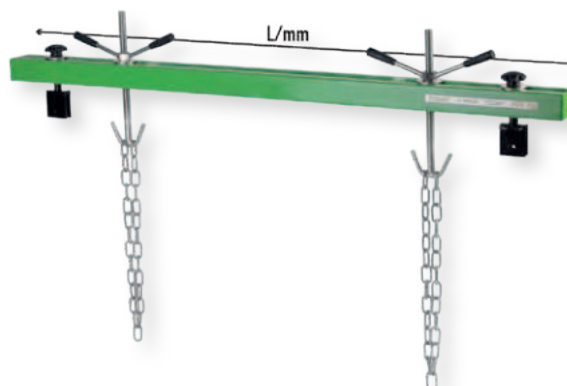

CONFIÁVEL

RÁPIDO

SEGURO



FG 750
PRENSA
PNEUMÁTICA
DE MOLA
DOS AMORTECEDORES



MADE IN ITALY

FG 750/1P

~~2.850,00€~~

1.599,00€

PRENSA PNEUMÁTICA PARA MOLAS DE AMORTECEDORES

Potência de impulso: 1,2 toneladas (10 bar) - 0,9 toneladas (8 bar)
 Curso de compressão da mola: 300 mm



FG 750/2P

~~3.400,00€~~

1.899,00€

PRENSA PNEUMÁTICA PARA MOLAS DE AMORTECEDORES

Potência de impulso: 2,4 toneladas (10 bar) - 1,9 toneladas (8 bar)
 Curso de compressão da mola: 300 mm



FG 752/1P

~~3.500,00€~~

1.999,00€

PRENSA PNEUMÁTICA PARA MOLAS DE AMORTECEDORES

COM DISPLAY DIGITAL

O visor digital mostra a pressão aplicada durante a utilização



FG 752/2P

~~4.200,00€~~

2.199,00€

PRENSA PNEUMÁTICA PARA MOLAS DE AMORTECEDORES

COM DISPLAY DIGITAL

O visor digital mostra a pressão aplicada durante a utilização



FG 213/LT~~330,00€~~**189,00€****ALAVANCA PARA PUXAR O BRAÇO E AMORTECEDORES****FG 740/0.5T**~~600,00€~~**319,00€****MACACO DE FOSSAS HIDRÁULICO**

Sistema de elevação a pedal
Equipado com 4 rodas giratórias
Portata 500 kg



CE

FG 213/SM~~790,00€~~**449,00€****SUPORTE PARA MOTORES INFERIOR**

Útil para apoiar o motor ou a caixa de velocidades durante os trabalhos de manutenção, tanto em veículos de passageiros como em veículos comerciais

**FG 738/1T**~~1.100,00€~~**599,00€****GRUA HIDRÁULICA REBATÍVEL**

Versão dobrável
Rodas de aço para maior durabilidade e capacidade
Portata 1.000 kg
L2/mm: 800 - A/mm: 80

CE

**FG 745/CMR**~~950,00€~~**529,00€****SUPORTE PARA MOTORES DOBRÁVEL**

Versão dobrável
Possibilidade de rotação de 360
Rodas de aço para maior durabilidade e capacidade
L1/mm: 995 - L2/mm 585



Sistema de rotação 360°
com manivela

FG 745/CMF

~~470,00€~~

269,00€

SUPOORTE PARA MOTORES

Possibilidade de rotação de 360°
Rodas de aço para maior durabilidade e capacidade
L1/mm: 860 - L2/mm 725



Sistema de rotação de 360°

FG 710/D

~~245,00€~~

129,00€

ASSENTO COM RODAS, EQUIPADO COM ACESSÓRIOS

Gaveta grande montada em corrediças telescópicas
Equipada com acessórios para peças pequenas e suportes para latas facilmente amovíveis



FG 710/C

~~150,00€~~

85,00€

ASSENTO COM RODAS, EQUIPADO COM ACESSÓRIOS

2 gavetas com corrediças telescópicas
Acessório porta-latas em plástico à prova de choque
Assento estofado e revestido a PVC



FG 710/E

~~150,00€~~

85,00€

ESTERIA DE PLÁSTICO À PROVA DE CHOQUE

6 rodízios giratórios



DIMENSÕES:
1000x470x130mm



FG 718/2.5T

470,00€

269,00€

MACACO HIDRÁULICO 2.5T MODELO CURTO

- Construção robusta em aço
- Velocidade de descida controlada
- Pega com borracha à prova de choque
- 4 rodas de nylon
- Válvula de purga de ar



FG 718/3.5T

562,00€

299,00€

MACACO HIDRÁULICO 3.5T MODELO CURTO E ABAIXADO

- Design baixo, ideal para trabalhar em veículos com pouca distância ao solo
- Elevada capacidade de carga para utilização também em veículos todo-o-terreno e carrinhas
- Construção robusta em aço
- Velocidade de descida controlada
- Pega com borracha à prova de choque
- 4 rodas de nylon
- Válvula de purga de ar

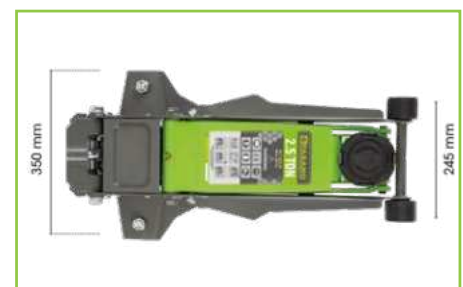

FG 719/2T

~~740,00€~~

399,00€

MACACO HIDRÁULICO 2T MODELO LONGO E ABAIXADO

Design baixo, ideal para trabalhar em veículos com pouca distância ao solo
 Versão longa
 Elevação através de pega com borracha à prova de choque
 Construção robusta em aço
 Velocidade de descida controlada
 4 rodas de nylon
 Válvula de purga de ar

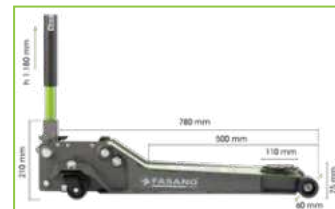

FG 721/2T

~~910,00€~~

479,00€

MACACO HIDRÁULICO 2T - MODELO LONGO E ABAIXADO COM RODAS BASCULANTES DUPLAS

É também ideal para trabalhar em veículos com pouca distância ao solo
 Pega de elevação revestido a borracha anti choque
 Construção robusta em aço
 Velocidade de descida controlada
 Equipado com válvula de libertação de ar
 6 rodas de nylon



MODELO REBAIXADO
 RODAS DIANTEIRAS INCLINÁVEIS



NEW



FG 722/5T

~~1.440,00€~~

799,00€

MACACO HIDRÁULICO DE 5 TONELADAS - MODELO LONGO PARA VEÍCULOS PESADOS

Sistema de elevação auxiliar com pedal
 Rodas de aço montadas em rolamentos de esferas
 Auto-retorno integrado



SISTEMA DE ELEVAÇÃO AUXILIAR COM PEDAL



RODAS DE AÇO MONTADAS EM ROLAMENTOS DE ESFERAS

CÓDIGO	PÁGINA	€/PROMO
FG BEST 108	10	139,00€
FG BEST 171	10	199,00€
FG 22/S6	14	21,90€
FG 22/S8B	14	31,90€
FG 22/S8	14	27,90€
FG 22/S12	14	49,90€
FG 22TX/S6	15	36,90€
FG 22RTX/S8	15	49,90€
FG 22FX/S10	15	89,90€
FG 22E/S6	18	34,90€
FG 22E/SZ6	18	34,90€
FG 39/S4	7	109,00€
FG 44/MT3	24	6,90€
FG 44/MT5	24	11,90€
FG 44/MT8	24	13,90€
FG 44/MT10	24	16,90€
FG 49/L	23	11,90€
FG 49/MU	23	17,90€
FG 49/TC	23	27,90€
FG 49/CF	23	17,90€
FG 49/HE200	23	13,90€
FG 49/HE250	23	16,90€
FG 49/HE300	23	21,90€
FG 49/HE350	23	24,90€
FG 49/TCX	23	34,90€
FG 51/S4	17	59,90€
FG 51/S4B	17	62,90€
FG 55/S4	17	79,90€
FG 55/S4B	17	82,90€
FG 58/C250	17	26,90€
FG 59XT/S3	17	49,90€
FG 59XT/S3B	17	59,90€
FG 59IS/S3	18	64,90€
FG 68U/S439	18	169,00€
FG 70/S110	22	199,00€
FG 75TIN/S25	22	139,00€
FG 75CO/S25	22	149,00€
FG 77/TT	23	5,90€
FG 77/PVC4	23	31,90€
FG 85/S31	16	39,90€
FG 85/175-S9	17	65,00€
FG 85/175-S10	17	69,00€
FG 88/25-S31	16	59,00€
FG 92/PM	25	11,90€
FG 92/PM4	25	13,90€
FG 92/GR	25	15,90€
FG 92/PF	25	14,90€
FG 93/M50	27	17,90€
FG 93/M95	27	17,90€
FG 94/MI	65	24,90€
FG 94/MS	65	18,90€
FG 94/R	65	11,90€
FG 94/T	65	9,90€
FG 95/CA	24	29,90€
FG 95/CA2	24	74,90€
FG 95/DG	24	56,90€
FG 96/DG	19	119,00€
FG 96/CA	24	32,90€
FG 96/CA2	24	69,00€
FG 96/SS36	26	39,90€
FG 96/SS30	26	29,90€
FG 96/SS60	26	36,00€
FG 97/DG	19	79,00€
FG 97/LT	133	149,00€
FG 98/DG	19	199,00€
FG 98/GAS	26	79,00€

CÓDIGO	PÁGINA	€/PROMO
FG 98/LT	26	119,00€
FG 98/A1	133	41,90€
FG 98/A6	133	75,00€
FG 98/A15	133	179,00€
FG 99/DG	19	149,00€
FG 100VD/7T	61	699,00€
FG 100VW/7T	61	699,00€
FG 100BW/7T	61	699,00€
FG 100BD/7T	61	699,00€
FG 100RD/7T	61	699,00€
FG 100RY/7T	61	699,00€
FG 100CW/7T	61	699,00€
FG 100MA/7T	61	699,00€
FG 100RW/7T	61	699,00€
FG 100RB/7T	61	699,00€
FG 100DP/7T	61	699,00€
FG 100DW/7T	61	699,00€
FG 100BY/7T	61	699,00€
FG 100GW/7T	61	699,00€
FG 100V/5T	61	519,00€
FG 100B/5T	61	519,00€
FG 100R/5T	61	519,00€
FG 100D/5T	61	519,00€
FG 100W/5T	61	519,00€
FG 100V/6T	61	539,00€
FG 100B/6T	61	539,00€
FG 100R/6T	61	539,00€
FG 100W/6T	61	539,00€
FG 100V/7T	61	559,00€
FG 100B/7T	61	559,00€
FG 100R/7T	61	559,00€
FG 100D/7T	61	559,00€
FG 100W/7T	61	559,00€
FG 100V/AS212	70	1.199,00€
FG 100B/AS212	70	1.199,00€
FG 100R/AS212	70	1.199,00€
FG 100D/AS212	70	1.199,00€
FG 100W/AS212	70	1.199,00€
FG 100V/AS183	71	1.199,00€
FG 100B/AS183	71	1.199,00€
FG 100R/AS183	71	1.199,00€
FG 100D/AS183	71	1.199,00€
FG 100W/AS183	71	1.199,00€
FG 100V/AS371	72	1.399,00€
FG 100B/AS371	72	1.399,00€
FG 100R/AS371	72	1.399,00€
FG 100D/AS371	72	1.399,00€
FG 100W/AS371	72	1.399,00€
FG 100V/AS224	79	1.199,00€
FG 100B/AS224	79	1.199,00€
FG 100R/AS224	79	1.199,00€
FG 100D/AS224	79	1.199,00€
FG 100W/AS224	79	1.199,00€
FG 100V/AS413	81	1.399,00€
FG 100B/AS413	81	1.399,00€
FG 100R/AS413	81	1.399,00€
FG 100D/AS413	81	1.399,00€
FG 100W/AS413	81	1.399,00€
FG 100V/AS230	82	1.399,00€
FG 100B/AS230	82	1.399,00€
FG 100R/AS230	82	1.399,00€
FG 100D/AS230	82	1.399,00€
FG 100W/AS230	82	1.399,00€
FG 100V/AS382	84	1.499,00€
FG 100B/AS382	84	1.499,00€

CÓDIGO	PÁGINA	€/PROMO
FG 100R/AS382	84	1.499,00€
FG 100D/AS382	84	1.499,00€
FG 100W/AS382	84	1.499,00€
FG 100VD/AS355	85	1.599,00€
FG 100VW/AS355	85	1.599,00€
FG 100BW/AS355	85	1.599,00€
FG 100BD/AS355	85	1.599,00€
FG 100RD/AS355	85	1.599,00€
FG 100RY/AS355	85	1.599,00€
FG 100CW/AS355	85	1.599,00€
FG 100MA/AS355	85	1.599,00€
FG 100RW/AS355	85	1.599,00€
FG 100RB/AS355	85	1.599,00€
FG 100DP/AS355	85	1.599,00€
FG 100DW/AS355	85	1.599,00€
FG 100BY/AS355	85	1.599,00€
FG 100GW/AS355	85	1.599,00€
FG 100V/AS56	91	1.299,00€
FG 100B/AS56	91	1.299,00€
FG 100R/AS56	91	1.299,00€
FG 100D/AS56	91	1.299,00€
FG 100W/AS56	91	1.299,00€
FG 100/03G	92	89,90€
FG 100/03G-A	92	99,90€
FG 100/03L	92	89,90€
FG 100/03L-A	92	99,90€
FG 100/03H	92	179,00€
FG 100/03H-A	92	189,00€
FG 100/03E	92	59,90€
FG 100/03F	92	69,00€
FG 100/07C	92	65,90€
FG 100/07D	92	95,90€
FG 100/08C	92	159,00€
FG 100/10C	92	249,00€
FG 100/10D	93	349,00€
FG 100/17	93	79,90€
FG 100/17E	93	169,00€
FG 100/18	93	179,00€
FG 100/19	93	139,00€
FG 100/21B	93	149,00€
FG 100/21C	93	149,00€
FG 100/21M	93	99,00€
FG 100/21D	93	99,00€
FG 100/21H	93	269,00€
FG 100/21TX	93	159,00€
FG 100/81F	93	119,00€
FG 100/23C	94	129,00€
FG 100/23B	94	219,00€
FG 100/39XT	94	66,90€
FG 100/41C	94	66,90€
FG 100/42C	94	73,90€
FG 100/65B	94	54,90€
FG 100/65C	94	86,90€
FG 100/45D	94	39,90€
FG 100/45E	94	49,90€
FG 100/45F	94	41,90€
FG 100/45G	94	41,90€
FG 100/45I	95	49,90€
FG 100/45T	95	52,90€
FG 100/45H	95	49,00€
FG 100/48G	95	79,90€
FG 100/51H	95	89,00€
FG 100/50F	95	53,90€
FG 100/50G	95	53,90€
FG 100/56C	95	89,90€
FG 100/54	95	119,00€

CÓDIGO	PÁGINA	€/PROMO
FG 100/76C	95	169,00€
FG 100/03M	92	279,00€
FG 100/45R	96	149,00€
FG 100/39F	97	239,00€
FG 100/39E	97	269,00€
FG 100/21F	98	599,00€
FG 100/81G	98	499,00€
FG 100/56D	99	229,00€
FG 100/95B	99	399,00€
FG 100/95C	99	449,00€
FG 101D/5G	64	359,00€
FG 101D/6G	64	379,00€
FG 101D/7G	64	399,00€
FG 101V/3G	65	249,00€
FG 101D/AS165	66	699,00€
FG 101D/AS196	67	799,00€
FG 102V/5G	60	469,00€
FG 102B/5G	60	469,00€
FG 102R/5G	60	469,00€
FG 102D/5G	60	469,00€
FG 102V/6G	60	499,00€
FG 102B/6G	60	499,00€
FG 102R/6G	60	499,00€
FG 102D/6G	60	499,00€
FG 102V/7G	60	529,00€
FG 102B/7G	60	529,00€
FG 102R/7G	60	529,00€
FG 102D/7G	60	529,00€
FG 102V/8G	60	559,00€
FG 102B/8G	60	559,00€
FG 102R/8G	60	559,00€
FG 102D/8G	60	559,00€
FG 102V/AS205	68	999,00€
FG 102B/AS205	68	999,00€
FG 102R/AS205	68	999,00€
FG 102D/AS205	68	999,00€
FG 102/03G	74	85,00€
FG 102/03L	74	89,00€
FG 102/03H	74	149,00€
FG 102/03E	74	51,90€
FG 102/03F	74	63,90€
FG 102/07C	74	59,90€
FG 102/07D	74	82,90€
FG 102/08C	74	149,00€
FG 102/10C	74	209,00€
FG 102/13C	74	119,00€
FG 102/17	75	79,90€
FG 102/17E	75	159,00€
FG 102/19	75	119,00€
FG 102/19B	75	119,00€
FG 102/21B	75	139,00€
FG 102/21C	75	139,00€
FG 102/21E	75	99,00€
FG 102/21D	75	99,00€
FG 102/21TX	75	139,00€
FG 102/21H	75	129,00€
FG 102/21R	75	139,00€
FG 102/25	75	239,00€
FG 102/25B	75	239,00€
FG 102/23C	76	89,00€
FG 102/51H	76	79,90€
FG 102/39XT	76	59,90€
FG 102/39D	76	45,90€
FG 102/41C	76	57,90€
FG 102/42C	76	59,90€
FG 102/45D	76	27,90€

CÓDIGO	PÁGINA	€/PROMO
FG 102/45E	76	33,90€
FG 102/45F	76	32,90€
FG 102/45G	76	32,90€
FG 102/45U	76	59,90€
FG 102/45I	77	39,90€
FG 102/45L	77	40,90€
FG 102/45T	77	39,90€
FG 102/48G	77	72,90€
FG 102/50F	77	45,90€
FG 102/50G	77	45,90€
FG 102/56C	77	79,90€
FG 102/60D	77	36,90€
FG 102/62B	77	59,90€
FG 102/65B	77	41,90€
FG 102/VA1	77	8,90€
FG 102V/AS335	89	1.499,00€
FG 102D/AS335	89	1.499,00€
FG 102B/AS335	89	1.499,00€
FG 102R/AS335	89	1.499,00€
FG 104V/6G	60	579,00€
FG 104B/6G	60	579,00€
FG 104R/6G	60	579,00€
FG 104D/6G	60	579,00€
FG 104V/7G	60	599,00€
FG 104B/7G	60	599,00€
FG 104R/7G	60	599,00€
FG 104D/7G	60	599,00€
FG 104V/AS284	88	1.599,00€
FG 104D/AS284	88	1.599,00€
FG 104B/AS284	88	1.599,00€
FG 104R/AS284	88	1.599,00€
FG 105V/5G	62	689,00€
FG 105B/5G	62	689,00€
FG 105R/5G	62	689,00€
FG 105D/5G	62	689,00€
FG 105V/6G	62	739,00€
FG 105B/6G	62	739,00€
FG 105R/6G	62	739,00€
FG 105D/6G	62	739,00€
FG 105V/7G	62	769,00€
FG 105B/7G	62	769,00€
FG 105R/7G	62	769,00€
FG 105D/7G	62	769,00€
FG 106/B	103	189,00€
FG 106/C	103	229,00€
FG 107/A	103	89,00€
FG 108/B	65	89,00€
FG 109V/6G	62	849,00€
FG 109B/6G	62	849,00€
FG 109R/6G	62	849,00€
FG 109D/6G	62	849,00€
FG 109V/7G	62	879,00€
FG 109B/7G	62	879,00€
FG 109R/7G	62	879,00€
FG 109D/7G	62	879,00€
FG 111/AS104	30	329,00€
FG 111/A	30	32,90€
FG 111/B	30	39,90€
FG 111/C	30	49,90€
FG 113/A	30	119,00€
FG 113/B	30	129,00€
FG 113/C	30	149,00€
FG 113/D	30	189,00€
FG 117/CO24V	109	2.499,00€
FG 117/CO24D	109	2.499,00€
FG 117/CO24B	109	2.499,00€

CÓDIGO	PÁGINA	€/PROMO
FG 117/CO24R	109	2.499,00€
FG 117V/AS210	110	2.699,00€
FG 117D/AS210	110	2.699,00€
FG 117B/AS210	110	2.699,00€
FG 117R/AS210	110	2.699,00€
FG 117/CO2V	111	1.799,00€
FG 117/CO2D	111	1.799,00€
FG 117/CO2B	111	1.799,00€
FG 117/CO2R	111	1.799,00€
FG 117/CO3V	111	1.999,00€
FG 117/CO3D	111	1.999,00€
FG 117/CO3B	111	1.999,00€
FG 117/CO3R	111	1.999,00€
FG 117/CO16V	112	1.599,00€
FG 117/CO16D	112	1.599,00€
FG 117/CO16B	112	1.599,00€
FG 117/CO16R	112	1.599,00€
FG 117/CO30V	112	3.499,00€
FG 117/CO30D	112	3.499,00€
FG 117/CO30B	112	3.499,00€
FG 117/CO30R	112	3.499,00€
FG 118/CO30V	105	3.399,00€
FG 118/CO30D	105	3.399,00€
FG 118/CO30B	105	3.399,00€
FG 118/CO30R	105	3.399,00€
FG 118/CO2V	106	2.499,00€
FG 118/CO2D	106	2.499,00€
FG 118/CO2B	106	2.499,00€
FG 118/CO2R	106	2.499,00€
FG 118/CO3V	106	2.899,00€
FG 118/CO3D	106	2.899,00€
FG 118/CO3B	106	2.899,00€
FG 118/CO3R	106	2.899,00€
FG 118/CO22V	107	7.899,00€
FG 118/CO22D	107	7.899,00€
FG 118/CO22B	107	7.899,00€
FG 118/CO22R	107	7.899,00€
FG 119V/CO16	119	899,00€
FG 119B/CO16	119	899,00€
FG 119R/CO16	119	899,00€
FG 119V/CO12	119	1.199,00€
FG 119B/CO12	119	1.199,00€
FG 119R/CO12	119	1.199,00€
FG 119V/CO25	120	949,00€
FG 119B/CO25	120	949,00€
FG 119R/CO25	120	949,00€
FG 119V/CO22	120	1.199,00€
FG 119B/CO22	120	1.199,00€
FG 119R/CO22	120	1.199,00€
FG 119V/CO33	121	1.599,00€
FG 119B/CO33	121	1.599,00€
FG 119R/CO33	121	1.599,00€
FG 119V/CO36	121	1.599,00€
FG 119B/CO36	121	1.599,00€
FG 119R/CO36	121	1.599,00€
FG 119V/CO18	122	999,00€
FG 119B/CO18	122	999,00€
FG 119R/CO18	122	999,00€
FG 119V/CO27	122	1.099,00€
FG 119B/CO27	122	1.099,00€
FG 119R/CO27	122	1.099,00€
FG 119M/CO13	123	499,00€
FG 119M/CO28	123	599,00€
FG 119M/CO37	123	699,00€
FG 120/CO1V	114	1.189,00€
FG 120/CO1D	114	1.189,00€

CÓDIGO	PÁGINA	€/PROMO
FG 120/CO1B	114	1.189,00€
FG 120/CO1R	114	1.189,00€
FG 120/CO2V	114	1.249,00€
FG 120/CO2D	114	1.249,00€
FG 120/CO2B	114	1.249,00€
FG 120/CO2R	114	1.249,00€
FG 120/CO3V	115	1.289,00€
FG 120/CO3D	115	1.289,00€
FG 120/CO3B	115	1.289,00€
FG 120/CO3R	115	1.289,00€
FG 120/CO4V	115	1.399,00€
FG 120/CO4D	115	1.399,00€
FG 120/CO4B	115	1.399,00€
FG 120/CO4R	115	1.399,00€
FG 120V/AS217	116	1.699,00€
FG 120D/AS217	116	1.699,00€
FG 120B/AS217	116	1.699,00€
FG 120R/AS217	116	1.699,00€
FG 120V/AS224	117	1.799,00€
FG 120D/AS224	117	1.799,00€
FG 120B/AS224	117	1.799,00€
FG 120R/AS224	117	1.799,00€
FG 121/B125	27	179,00€
FG 121/B150	27	229,00€
FG 121/B200	27	339,00€
FG 122V/5G	59	499,00€
FG 122D/5G	59	499,00€
FG 122B/5G	59	499,00€
FG 122R/5G	59	499,00€
FG 122V/6G	59	529,00€
FG 122D/6G	59	529,00€
FG 122B/6G	59	529,00€
FG 122R/6G	59	529,00€
FG 122V/7G	59	569,00€
FG 122D/7G	59	569,00€
FG 122B/7G	59	569,00€
FG 122R/7G	59	569,00€
FG 122V/AS168	69	1.199,00€
FG 122D/AS168	69	1.199,00€
FG 122B/AS168	69	1.199,00€
FG 122R/AS168	69	1.199,00€
FG 122V/AS217	78	1.099,00€
FG 122D/AS217	78	1.099,00€
FG 122B/AS217	78	1.099,00€
FG 122R/AS217	78	1.099,00€
FG 122V/AS283	80	1.349,00€
FG 122D/AS283	80	1.349,00€
FG 122B/AS283	80	1.349,00€
FG 122R/AS283	80	1.349,00€
FG 122V/AS402	83	1.499,00€
FG 122D/AS402	83	1.499,00€
FG 122B/AS402	83	1.499,00€
FG 122R/AS402	83	1.499,00€
FG 124V/6G	59	639,00€
FG 124D/6G	59	639,00€
FG 124B/6G	59	639,00€
FG 124R/6G	59	639,00€
FG 124V/7G	59	689,00€
FG 124D/7G	59	689,00€
FG 124B/7G	59	689,00€
FG 124R/7G	59	689,00€
FG 124V/AS231	73	1.499,00€
FG 124D/AS231	73	1.499,00€
FG 124B/AS231	73	1.499,00€
FG 124R/AS231	73	1.499,00€
FG 124V/AS322	86	1.599,00€

CÓDIGO	PÁGINA	€/PROMO
FG 124D/AS322	86	1.599,00€
FG 124B/AS322	86	1.599,00€
FG 124R/AS322	86	1.599,00€
FG 125/S3	27	41,90€
FG 125/LV	131	11,90€
FG 127/S1	25	29,90€
FG 128C/S6	25	27,90€
FG 128/2	100	349,00€
FG 128/D2	100	479,00€
FG 128/B2	100	479,00€
FG 128/R2	100	479,00€
FG 129/2	100	449,00€
FG 129/D2	100	579,00€
FG 129/B2	100	579,00€
FG 129/R2	100	579,00€
FG 129/1	101	289,00€
FG 129/D1	101	359,00€
FG 129/B1	101	359,00€
FG 129/R1	101	359,00€
FG 129/1.5	101	339,00€
FG 129/D1.5	101	419,00€
FG 129/B1.5	101	419,00€
FG 129/R1.5	101	419,00€
FG 130AL/S5	139	22,90€
FG 131/D2	102	899,00€
FG 131/B2	102	899,00€
FG 131/R2	102	899,00€
FG 132/200	27	11,90€
FG 132/300	27	12,90€
FG 132/500	27	13,90€
FG 132/800	27	17,90€
FG 132/1000	27	18,90€
FG 134/H800	27	13,90€
FG 134/H1000	27	14,90€
FG 134/H1250	27	15,90€
FG 134/H1500	27	18,90€
FG 134/H2000	27	22,90€
FG 137/D1.5	102	739,00€
FG 137/B1.5	102	739,00€
FG 137/R1.5	102	739,00€
FG 138/BP	16	35,90€
FG 138/M	16	37,90€
FG 138	16	29,90€
FG 138/B	16	17,90€
FG 138/C	16	19,90€
FG 139/B	15	9,90€
FG 139/C	15	13,90€
FG 139/LM	15	32,90€
FG 139	15	22,90€
FG 139/L	15	24,90€
FG 139/IN	15	22,90€
FG 150TX/S32	11	125,00€
FG 150M/S26	12	109,00€
FG 150H/S30	12	119,00€
FG 150D/5G	64	589,00€
FG 150R/5G	64	589,00€
FG 150D/6G	64	629,00€
FG 150R/6G	64	629,00€
FG 150D/7G	64	659,00€
FG 150R/7G	64	659,00€
FG 152/RTXS10	13	99,00€
FG 152RH/S9	13	69,00€
FG 152RM/S9	13	69,00€
FG 159/PM	132	139,00€
FG 160V/14L	63	1.699,00€
FG 160D/14L	63	1.699,00€

CÓDIGO	PÁGINA	€/PROMO
FG 160B/14L	63	1.699,00€
FG 160R/14L	63	1.699,00€
FG 162/S3	48	229,00€
FG 162/FR1	48	89,90€
FG 162/FR2	48	119,00€
FG 162/FR3	48	139,00€
FG 162V/14P	63	1.799,00€
FG 162D/14P	63	1.799,00€
FG 162B/14P	63	1.799,00€
FG 162R/14P	63	1.799,00€
FG 162V/AS288	87	2.799,00€
FG 162D/AS288	87	2.799,00€
FG 162B/AS288	87	2.799,00€
FG 162R/AS288	87	2.799,00€
FG 165/IE1	48	189,00€
FG 165/IE2	48	459,00€
FG 165/MB1	49	99,00€
FG 165/MB2	49	199,00€
FG 165/S26	132	459,00€
FG 165/BC1	145	28,90€
FG 165/BC3	145	42,90€
FG 165BC/S6	145	139,00€
FG 166/S7	132	329,00€
FG 166/S28	132	299,00€
FG 168/EF1	48	195,00€
FG 168/EF2	48	205,00€
FG 168SD/S4	49	95,00€
FG 168A/S5	49	69,00€
FG 168A/S13	49	129,00€
FG 168EP/S5	49	19,90€
FG 168/S25	49	79,00€
FG 168/S9	49	119,00€
FG 168/GA	132	37,90€
FG 168/S7	132	169,00€
FG 171/B	135	28,90€
FG 171/FL	135	29,90€
FG 172/FA2	134	53,90€
FG 172/FA	134	39,90€
FG 172/PA	134	42,90€
FG 172/MA	134	59,90€
FG 172/AS2	134	69,90€
FG 172/TC	134	19,90€
FG 172/TG	134	23,90€
FG 172/GO2	135	62,90€
FG 172/OT	135	33,90€
FG 172/S4	135	19,90€
FG 172/CA	135	34,90€
FG 174/F2	129	43,50€
FG 174/SC	129	74,90€
FG 175/FO74.5-8	124	29,90€
FG 175/HI	124	39,90€
FG 175/S30	124	129,00€
FG 175/FO84	124	33,90€
FG 175/OP1	124	27,90€
FG 175/S6	124	39,90€
FG 175/S15	125	79,90€
FG 175/PR	125	23,90€
FG 175/S114	125	159,00€
FG 175/FT2	128	49,90€
FG 175/FT4	128	42,90€
FG 175/FT1	128	39,90€
FG 175/FT3	128	51,90€
FG 175/FT5	128	42,90€
FG 176/S13	126	259,00€
FG 178/UF83	125	20,90€
FG 178/FL	125	28,90€

CÓDIGO	PÁGINA	€/PROMO
FG 178/UF110	125	69,00€
FG 178/UF145	125	99,00€
FG 178/SF	130	899,00€
FG 178SF/AD13	130	35,90€
FG 178SF/AD14	130	35,90€
FG 178/S6	130	189,00€
FG 178/BF	131	149,00€
FG 179/S16	129	89,00€
FG 180/SP9	5	129,00€
FG 180/S12	130	51,90€
FG 180/S17	130	199,00€
FG 180/S38	130	419,00€
FG 181/PM2	134	49,00€
FG 182/S5B	49	285,00€
FG 182/S14	49	149,00€
FG 182/S16	129	319,00€
FG 182/RG10	141	11,90€
FG 182/RG24	141	15,90€
FG 183/S5	129	69,00€
FG 183/RV1	141	12,90€
FG 183/CM	144	29,90€
FG 183/CK250	144	12,90€
FG 183/CK450	144	19,90€
FG 183/CK600	144	25,90€
FG 183/RA1	144	15,90€
FG 184/S5	135	99,00€
FG 184R/S3	139	27,90€
FG 184/R2	139	13,90€
FG 184P/S3	139	15,90€
FG 184/R1	139	12,90€
FG 185/S5	140	59,00€
FG 185B/S2	140	24,90€
FG 185P/S4	140	16,90€
FG 185/CR	141	5,90€
FG 185/RM	141	18,90€
FG 185/OM	141	18,90€
FG 186/S11	139	69,00€
FG 186/S3	140	6,90€
FG 186/S3B	140	6,90€
FG 186P/S5	140	19,90€
FG 186/AL1	140	14,90€
FG 186/S5	140	58,90€
FG 186/S4	141	15,90€
FG 187/GU	142	17,90€
FG 187/S7	142	139,00€
FG 187/GR	142	17,90€
FG 187/GU2	142	16,90€
FG 187/K25	142	28,90€
FG 187/S2	145	439,00€
FG 187/K40	145	119,00€
FG 187/K30	145	43,90€
FG 187/PN	145	169,00€
FG 188P/S2	139	24,90€
FG 188/P1	140	11,90€
FG 188P/S4	145	42,90€
FG 189/S13	129	159,00€
FG 189/PO1	141	12,90€
FG 189/PO2	141	23,90€
FG 190/S6B	128	99,00€
FG 191/S22	127	389,00€
FG 191/S24	127	299,00€
FG 191/S14	128	89,00€
FG 193DSG/S9	137	629,00€
FG 193/DCT	137	99,00€
FG 193/DS1	137	19,90€
FG 193/DS2	137	19,90€

CÓDIGO	PÁGINA	€/PROMO
FG 193/S4	137	299,00€
FG 193/ATJ	137	26,90€
FG 193/MB	137	39,00€
FG 194/TS	137	21,90€
FG 198/S11	131	82,90€
FG 198/PE	135	37,90€
FG 199/PF	131	139,00€
FG 199/SF	131	37,90€
FG 201	34	29,90€
FG 201/S7	126	209,00€
FG 202	34	33,90€
FG 203	32	12,90€
FG 203/S20	126	209,00€
FG 203/BW1	126	21,90€
FG 203/FO1	126	21,90€
FG 203/FO2	126	21,90€
FG 203/FT1	126	26,90€
FG 203/OP1	126	21,90€
FG 203/TO1	126	22,90€
FG 203/S7	126	99,00€
FG 204	32	19,90€
FG 205/B	35	49,90€
FG 206	34	33,90€
FG 207	33	37,90€
FG 207/B	33	59,90€
FG 209	37	149,00€
FG 210/B	37	49,90€
FG 210/C	36	99,00€
FG 210/W	38	44,90€
FG 211	33	59,90€
FG 212	33	42,90€
FG 213/L480	32	39,90€
FG 213/DP	38	56,90€
FG 213/W	39	62,90€
FG 213/S3	39	165,90€
FG 213/LT	146	189,00€
FG 213/SM	146	449,00€
FG 214/L600	34	39,90€
FG 215/S40	136	899,00€
FG 217/B	35	169,00€
FG 219/S	136	1.999,00€
FG 220/BT	133	249,00€
FG 221	36	159,00€
FG 222/A	35	49,00€
FG 222/B	37	169,00€
FG 224/L5200	36	129,00€
FG 224/SU	36	49,00€
FG 225/SK1.5	41	159,00€
FG 225/SK2.5	41	179,00€
FG 234	40	59,00€
FG 235	40	79,00€
FG 236	41	199,00€
FG 236/SU	41	59,00€
FG 305/LT2	44	499,00€
FG 310/LT2	44	539,00€
FG 315/LT2	45	599,00€
FG 320/LT2	45	649,00€
FG 330/LT2	45	549,00€
FG 360/LT1	46	299,00€
FG 363/LT1	46	309,00€
FG 366/LT1	46	319,00€
FG 370/LT1	47	369,00€
FG 373/LT1	47	359,00€
FG 380/LT1	47	319,00€
FG 383/LT1	47	299,00€
FGA 290	51	119,00€

CÓDIGO	PÁGINA	€/PROMO
FGA 291/D	51	119,00€
FGA 292/B	51	139,00€
FGA 302	51	139,00€
FGA 307	50	149,00€
FGA 307/AN	50	189,00€
FGA 309	50	179,00€
FGA 309/S4	51	239,00€
FGA 309/S10	51	249,00€
FGA 312	50	199,00€
FGA 316	52	449,00€
FGA 316/L	52	499,00€
FGA 319	52	699,00€
FGA 319/L	52	799,00€
FGA 321	52	649,00€
FGA 321/B	52	669,00€
FGA 321/C	52	749,00€
FGA 322	53	85,00€
FGA 330	55	179,00€
FGA 332	53	89,00€
FGA 332/AN	53	109,00€
FGA 333/AC	53	129,00€
FGA 333	53	109,00€
FGA 334	56	89,00€
FGA 334/AN115	56	109,00€
FGA 334/AN	56	109,00€
FGA 334/L	56	109,00€
FGA 335	55	119,00€
FGA 336	55	379,00€
FGA 337	55	79,00€
FGA 338	56	75,00€
FGA 338/B	56	99,00€
FGA 338/AN	56	99,00€
FGA 338/L	56	99,00€
FGA 339	55	199,00€
FGA 340	54	169,00€
FGA 340/B	54	169,00€
FGA 341	54	399,00€
FGA 342/B	54	169,00€
FGA 342	54	129,00€
FGA 343/N10	54	139,00€
FGA 343/N20	54	179,00€
FGA 346/B	55	139,00€
FGA 383/AR15	57	149,00€
FGA 385/AR15	57	199,00€
FGA 390	53	89,00€
FGA 416	57	13,90€
FGA 419	57	14,90€
FG 491/200	126	23,90€
FG 491/1500	126	51,90€
FG 491/DF1500	126	79,90€
FG 493/AL	27	28,90€
FG 493/N	27	23,90€
FG 494/S12	26	33,90€
FG 494/A180	26	109,00€
FG 531	20	132,00€
FG 533/2	20	142,00€
FG 536/1-IS	18	439,00€
FG 536/1	20	145,00€
FG 536/2	20	149,00€
FG 536/3	20	169,00€
FG 538/1	20	499,00€
FG 538/2	20	559,00€
FG 539/1	20	699,00€
FG 540/1	20	629,00€
FG 540/2	20	719,00€
FG 543/DG1	21	399,00€

CÓDIGO	PÁGINA	€/PROMO
FG 543/DG2	21	469,00€
FG 546/DG	21	199,00€
FG 547/DG	21	125,00€
FG 559/1	21	129,00€
FG 559/2	21	139,00€
FG 581/A	21	499,00€
FG 581/B	21	799,00€
FG 600A/SC16	4	149,00€
FG 600A/SC25	4	229,00€
FG 600/SC16	4	139,00€
FG 600/SC25	4	209,00€
FG 600TW/S12	5	115,00€
FG 600XL/SC11	5	219,00€
FG 602/SC13	4	95,00€
FG 603/S28A	90	539,00€
FG 603/S28B	90	539,00€
FG 603/TA1	91	159,00€
FG 605/ST11-B	7	145,00€
FG 605/SC15	7	159,00€
FG 606/SP9	7	85,00€
FG 610FL/SP11	7	179,00€
FG 613/S11	5	139,00€
FG 614C/S8	5	139,00€
FG 615/SC8	5	69,90€
FG 615A/S6	7	75,00€
FG 618/S7B	6	159,00€
FG 618/S7	6	179,00€
FG 618/S10	6	249,00€
FG 621H/S8	6	85,00€
FG 621H/S8C	6	89,00€
FG 621H/S14	6	179,00€
FG 622A/S2	7	49,00€
FG 623H/S6	6	79,20€
FG 623H/S8	6	119,00€
FG 623H/S14	6	239,00€
FG 624/S25	8	49,90€
FG 624/S25A	8	49,90€
FG 624/S45	9	129,00€
FG 624B/S80	9	119,00€
FG 625/S27	9	109,00€
FG 625/S110	11	259,00€
FG 625AM/S3	13	29,90€
FG 628/S12	13	79,00€
FG 628/S6	13	55,00€
FG 628/S7	131	69,00€
FG 629A/S15	12	339,00€
FG 629B/S15	12	339,00€
FG 629C/S10	13	169,00€
FG 630A/S14	13	499,00€
FG 710/C	147	85,00€
FG 710/E	147	85,00€
FG 710/D	147	129,00€
FG 712/L4	25	49,00€
FG 712/A	25	19,90€
FG 718/2.5T	148	269,00€
FG 718/3.5T	148	299,00€
FG 719/2T	149	399,00€
FG 721/2T	149	479,00€
FG 722/5T	149	799,00€
FG 725/3T	144	55,90€
FG 725/6T	144	95,00€
FG 725/12T	144	169,00€
FG 735/4T	144	49,00€
FG 735/6T	144	55,00€
FG 735/10T	144	79,00€
FG 735/16T	144	89,00€

CÓDIGO	PÁGINA	€/PROMO
FG 735/20T	144	109,00€
FG 738/1T	146	599,00€
FG 740/0.5T	146	319,00€
FG 745/CMR	146	529,00€
FG 745/CMF	147	269,00€
FG 748/0.5T	144	139,00€
FG 750/A	144	249,00€
FG 750/1P	145	1.599,00€
FG 750/2P	145	1.899,00€
FG 752/1P	145	1.999,00€
FG 752/2P	145	2.199,00€
FG 1450	28	83,90€
FG 1452	28	89,00€
FG 1454	28	119,00€
FG 1456	29	149,00€
FG 1460	29	89,00€
FG 1465	29	119,00€



cunha  mendes cunha, lda
Equipamentos Industriais

SIGA-NOS EM:  www.facebook.com/CunhaMendesCunhaLda
 www.youtube.com/c/CUNHAMENDESCUNHALDA
 www.cmc.pt

Zona Industrial do Socorro, Lote 28A 4820-011
São Gens - Fafe - Portugal

