

02

SOCKET WRENCHES



1/4"dr. HEXAGONAL SOCKET WRENCH

→ **USE:**
hexagonal bolts

→ **FINISHING:**
mirror

CODE	mm	A/mm	B/mm	D/mm	E/mm
FG 624/E4	4	6.8	11.6	25.3	8.4
FG 624/E5	5	7.9	12.0	25.4	9.0
FG 624/E6	6	9.5	12.0	25.4	11.6
FG 624/E7	7	10.5	12.0	25.4	11.6
FG 624/E8	8	12.0	12.0	25.5	11.0
FG 624/E9	9	12.9	12.9	25.5	10.6
FG 624/E10	10	14.4	14.4	25.5	12.0
FG 624/E11	11	15.6	15.6	25.5	11.7
FG 624/E12	12	16.7	16.7	25.3	11.6
FG 624/E13	13	17.7	17.7	25.5	11.6
FG 624/E14	14	17.7	17.7	25.5	11.6

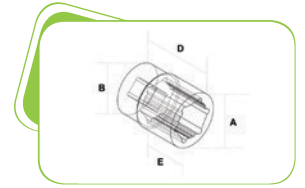

Set 11pcs 1/4"dr. hexagonal sockets wrenches

CODE	Pz	CONTENT
FG 624/S11	11	4, 5, 6, 7, 8, 9, 10, 11, 12, 13, 14 mm

Set 11pcs 1/4"dr. hexagonal sockets wrenches and ratchet handle

CODE	Pz	CONTENT
FG 624/S12	12	4, 5, 6, 7, 8, 9, 10, 11, 12, 13, 14 mm FG 624/CR14



FG 624/E: 5, 6, 8, 10, 11, 13mm

FG 624/MCR14

FG 89/38PI1 (1/4x1/4)

FG 85/25PH1, PH2, PH3

FG 85/25PZ1, PZ2, PZ3

FG 85/25F3, F5

FG 85/25H4, H5, H6

FG 85/25TX10, TX15, TX20, TX25, TX30, TX40



Set of 25pcs 1/4" of tools

CODE	Pc
FG 624/S25A	25



FG 624/E: 6, 8, 10, 11, 12, 13mm

FG 624/CR14

FG 89/38PI1 (1/4x1/4)

FG 85/25PH1, PH2, PH3

FG 85/25PZ1, PZ2, PZ3

FG 85/25F4, F5, F6, F7

FG 85/25TX10, TX15, TX20, TX25, TX30, TX40



Set of 25pcs 1/4" of tools

CODE	Pc
FG 624/S25	25





Set of 18pcs 1/4" of tools

CODE	Pcs	
FG 624/S18	18	

FG 624/E4,5,6,7,8,9,10,11,12,13,14mm

FG 624/CR14

FG 624/ES14
FG 624/PA50, 100
FG 624/PRF150

FG 624/GR14C

FG 624/SN14



Set of 45pcs 1/4" of tools

CODE	Pcs	
FG 624/S45	45	

FG 624/E4,5,6,7,8,9,10,11,12,13,14mm

FG 624/CR14

FG 624/ES14
FG 624/PA50, 100
FG 624/PRF150

FG 624/SN14

FG 624/GR14C

FG 148/H1.5-H10, FG 148/TX8-TX40
FG 148/PH1-PH4, FG 148/F1-F5

Soft form of 18pcs 1/4"dr. tools

CODE	Pc	
FG 100/17	18	



Soft form of 65pcs 1/4"dr. tools

CODE	Pc	
FG 102/17	18	



FG 624/E4,5,6,7,8,9,10,11,12,13,14mm

FG 624/CR14

FG 624/SN14

FG 624/GR14C

FG 624/PA50, 100
FG 624/PRF150
FG 624/ES14

Plateaux souple de 65 outils de 1/4"

CODE	Pc	
FG 100/17E	65	



Rigid form of 65pcs 1/4"dr. tools

CODE	Pc	
FG 102/17E	65	



4,5,6,7,8,9,10,11,12,13,14mm

FG 624/CR14

FG 624/PA50, 100
FG 624/PRF150
FG 624/ES14

FG 624/SN14

FG 624/GR14C

FG 147/H2.5-H10
FG 147/PH1-PH4
FG 147/TX9-TX40
FG 147/F1-F5

FG 139/L



1/4"dr. HEXAGONAL SOCKET WRENCH deep series

→ USE

hexagonal bolts

→ FINISH

mirror

CODE	mm	A/mm	B/mm	C/mm	L/mm
FG 624E/L4	4	7.0	12.0	4.0	51.0
FG 624E/L5	5	8.0	12.0	9.0	51.0
FG 624E/L6	6	9.0	12.0	11.0	51.0
FG 624E/L7	7	11.0	12.0	21.0	51.0
FG 624E/L8	8	11.0	12.0	21.0	51.0
FG 624E/L9	9	13.0	12.0	21.0	51.0
FG 624E/L10	10	15.0	15.0	21.0	51.0
FG 624E/L11	11	15.1	15.0	21.0	51.0
FG 624E/L12	12	16.8	15.6	21.0	51.0
FG 624E/L13	13	16.8	15.6	21.0	51.0
FG 624E/L14	14	19.8	17.7	21.0	51.0

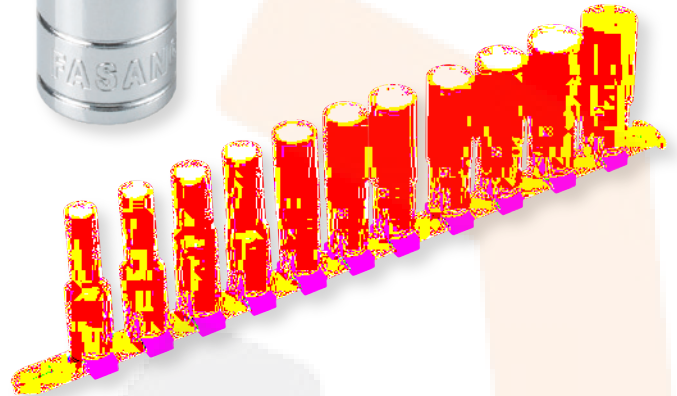
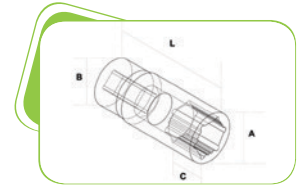

Set of 11 pcs 1/4"dr. hexagonal sockets wrenches

CODE	Pc	CONTENT
FG 624L/S11	11	4, 5, 6, 7, 8, 9, 10, 11, 12, 13, 14 mm



Set of 29 pcs 1/4"dr tools

CODE	Pz
FG 624/S29	29



1/4"dr. HEXAGONAL SOCKET WRENCH

CODE	Pouces	A/mm	B/mm	D/mm	E/mm
FG 624A/IN1	5/32	6.8	11.6	25.3	8.4
FG 624A/IN2	3/16	7.7	12.0	25.4	10.7
FG 624A/IN3	7/32	8.7	12.0	25.4	10.9
FG 624A/IN4	1/4	9.5	12.0	25.4	11.6
FG 624A/IN5	9/32	10.5	12.0	25.4	11.6
FG 624A/IN6	5/16	12.0	12.0	25.5	11.0
FG 624A/IN7	11/32	12.9	12.9	25.5	10.6
FG 624A/IN8	3/8	14.4	14.4	25.5	12.0
FG 624A/IN9	7/16	15.6	15.6	25.5	11.7
FG 624A/IN10	15/32	16.7	16.7	25.3	11.6
FG 624A/IN11	1/2	17.7	17.7	25.5	11.6
FG 624A/IN12	9/16	17.7	17.7	25.5	11.6

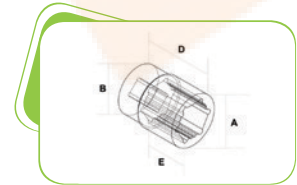

Set of 12 pcs 1/4"dr. INCH hexagonal sockets wrenches

CODE	Pc	CONTENT
FG 624A/INS12	12	5/32, 3/16, 7/32, 1/4, 9/32, 5/16, 11/32, 3/8, 7/16, 15/32, 1/2, 9/16

1/4"dr. UNIVERSAL SOCKET WRENCH

→ USE

Hexagonal bolts, TORX, XZN, 12points and Square bolts

→ FINISH

mirror

CODE	mm	E	■	B/mm	C/mm
FG 624/U4	4	E5		7.0	9.5
FG 624/U4.5	4.5			7.5	9.5
FG 624/U5	5	E6		8.0	9.5
FG 624/U5.5	5.5			8.8	10.0
FG 624/U6	6	E8		9.6	10.0
FG 624/U7	7			10.6	10.0
FG 624/U8	8	E10		11.6	10.0
FG 624/U9	9			13.4	11.5
FG 624/U10	10	E12	8	14.0	11.5
FG 624/U11	11	E14		15.8	11.5
FG 624/U12	12	E16	10	16.9	11.5
FG 624/U13	13	E18	11	18.0	11.5
FG 624/U14	14		12	20.0	11.5

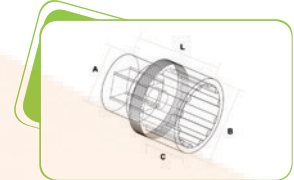

Set of 13pcs 1/4"dr. UNIVERSAL socket wrenches

CODE	Pc	CONTENT
FG 624U/S13	13	4, 4.5, 5, 5.5, 6, 7, 8, 9, 10, 11, 12, 13, 14mm

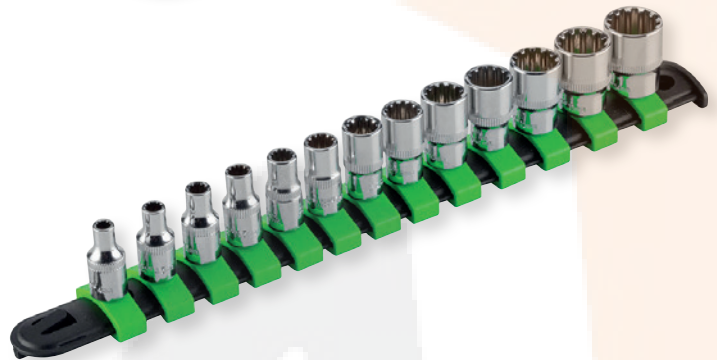

1/4"dr. TORX SOCKET WRENCH

→ USE

Torx bolts

→ FINISH

mirror

CODE	E	A/mm	B/mm	L/mm
FG 624/TX4	4	11.8	6.8	25.0
FG 624/TX5	5	11.8	8.0	25.0
FG 624/TX6	6	11.8	9.3	25.0
FG 624/TX7	7	11.8	10.6	25.0
FG 624/TX8	8	11.8	11.8	25.0
FG 624/TX10	10	11.8	11.8	25.0

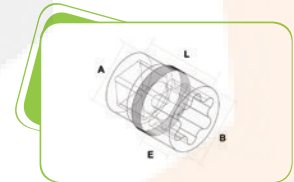

Set of 6pcs 1/4"dr. Torx sockets

CODE	Pc	CONTENT
FG 624TX/S6	6	4, 5, 6, 7, 8, 10 E



Set of 6pcs 1/4" Torx sockets + 8pcs 1/4"dr Torx socket bits + accessories

CODE	CONTENT
FG 624TX/S17	SOCKETS: TX4, TX5, TX6, TX7, TX8, TX10 SOCKET BITS: TX9, TX10, TX15, TX20, TX25, TX27, TX30, TX40 1/4"dr. EXTENSION - 100mm 1/4"dr JOINT + 1/4"dr. SLIDING BAR





1/4"dr. Torx socket bit



CODE	TX	L/mm	
FG 147/TX9	9	36.0	
FG 147/TX10	10	36.0	
FG 147/TX15	15	36.0	
FG 147/TX20	20	36.0	

CODE	TX	L/mm	
FG 147/TX25	25	36.0	
FG 147/TX27	27	36.0	
FG 147/TX30	30	36.0	
FG 147/TX40	40	36.0	

Set 8pcs 1/4"dr. TORX socket bits

CODE	Pc	CONTENT	
FG 147TX/S8	8	TX9, 10, 15, 20, 25, 27, 30, 40	

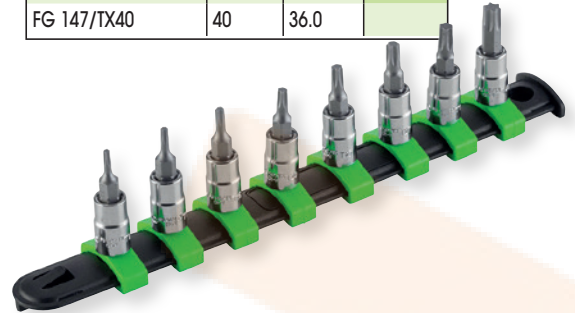

1/4"dr. socket bit for 5-star head screws



CODE	TX	L/mm	
FG 147/PT10	10	36.0	
FG 147/PT15	15	36.0	
FG 147/PT20	20	36.0	

CODE	TX	L/mm	
FG 147/PT25	25	36.0	
FG 147/PT27	30	36.0	
FG 147/PT30	25	36.0	

Set of 6pcs 1/4"dr. socket bits for 5 star head screws

CODE	Pc	CONTENT	
FG 147PT/S6	6	PT10, 15, 20, 25, 27, 30	

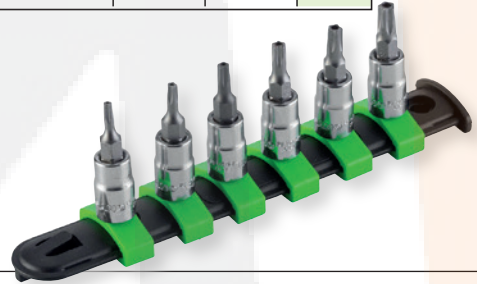

1/4"dr. hex socket bit



CODE	mm	L/mm	
FG 147/H2.5	2.5	36.0	
FG 147/H3	3	36.0	
FG 147/H4	4	36.0	
FG 147/H5	5	36.0	

CODE	mm	L/mm	
FG 147/H6	6	36.0	
FG 147/H7	7	36.0	
FG 147/H8	8	36.0	
FG 147/H10	10	36.0	

Set of 8pcs 1/4"dr. socket bits for hex screws

CODE	Pc	CONTENT	
FG 147H/S8	8	2.5, 3,4,5,6,7,8,10	

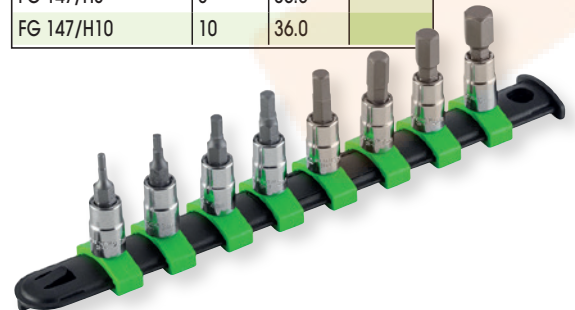

1/4"dr. Phillips socket bit



CODE	PH	L/mm	
FG 147/PH1	1	36.0	
FG 147/PH2	2	36.0	
FG 147/PH3	3	36.0	
FG 147/PH4	4	36.0	



1/4"dr. slotted socket bit



CODE	mm	L/mm	
FG 147/SL4	0.8X4.0	36.0	
FG 147/SL5.5	1.0x5.5	36.0	
FG 147/SL6.5	1.2x6.5	36.0	
FG 147/SL8	1.6x8.0	36.0	
FG 147/SL10	1.6x10.0	36.0	



1/4"dr. Reversible ratchet handle

CODICE	■	
FG 624/CR14	1/4"	

- Ring-shaped inversion system integrated on the head
- 72 tooth mechanism
- Mirror finish
- Hook-in slot

1/4"dr. Reversible ratchet handle - TWISTER HANDLE

CODICE	■	
FG 624/RT14	1/4"	



Cricchetto reversibile 1/4" a 72 denti

CODE	■	
FG 624/FR14	1/4"	



NEW



- Model with closed dust-proof head
- Integrated reversing lever flush with the head
- 13 ° hollow body to allow use even in particularly difficult spaces
- 72 tooth mechanism
- Mirror finish
- Hook-in slot



1/4"dr. stubby ratchet

CODICE	■	
FG 624/MCR	1/4"	



1/4"dr. stubby ratchet for bits

CODICE	□	
FG 624/MCH	1/4"	



1/4"dr. Swivel drive with handle

CODICE	L/mm	
FG 624/CS14	160	



1/4"dr. female and male drive wobble extension bar

CODE	L/mm	
FG 624/PA50	50	
FG 624/PA100	100	

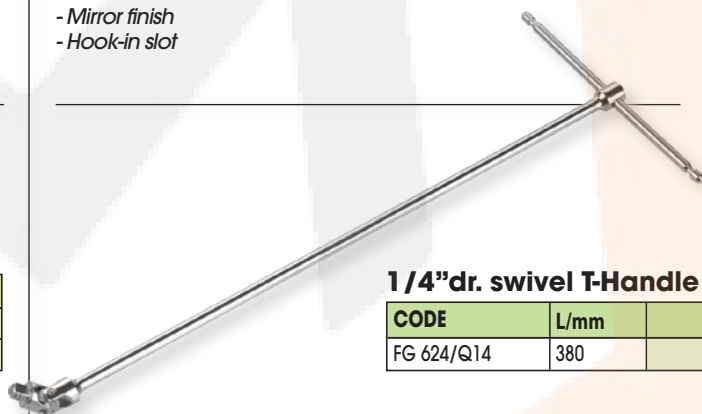

1/4"dr. swivel T-Handle

CODE	L/mm	
FG 624/Q14	380	



1/4"dr. female and male drive extension bar

CODE	L/mm	
FG 624/PR50	50	
FG 624/PR100	100	
FG 624/PR150	150	



1/4" sliding bar

CODE	L/mm	
FG 624/ES14	115	



1/4"dr. female and male drive extension bar - flexible

CODE	L/mm	
FG 624/PRF150	150	



CODE		L/mm	
FG 624/GR14B	flexible	291.6	
FG 624/GR14C	NO flexible	246.6	



1/4" universal joint

CODE	L/mm	
FG 624/SN14	38	



3/8"dr. HEXAGONAL SOCKET WRENCH

→ USE

hexagonal bolts

→ FINISH

mirror

CODE	mm	A/mm	B/mm	D/mm	E/mm
FG 624/B8	8	12.2	20.0	32.0	5.0
FG 624/B9	9	13.5	20.0	32.0	5.0
FG 624/B10	10	14.7	20.0	32.0	6.0
FG 624/B11	11	16.0	20.0	32.0	7.0
FG 624/B12	12	17.2	20.0	32.0	8.0
FG 624/B13	13	18.5	20.0	32.0	8.0
FG 624/B14	14	19.8	20.0	32.0	10.0
FG 624/B15	15	21.0	21.0	35.0	10.0
FG 624/B16	16	22.2	23.0	35.0	10.0
FG 624/B17	17	23.8	24.0	35.0	10.0
FG 624/B18	18	24.8	24.0	35.0	12.0
FG 624/B19	19	26.0	24.0	35.0	12.0
FG 624/B21	21	28.5	27.0	35.0	12.0
FG 624/B22	22	29.7	28.0	38.0	14.0
FG 624/B23	23	31.5	28.8	38.0	14.0

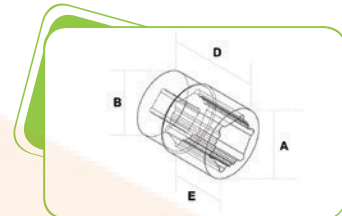

Set of 15pcs 3/8"dr. hex sockets

CODE	Pc	CONTENT
FG 624B/S15	15	8, 9, 10, 11, 12, 13, 14, 15, 16, 17, 18, 19, 21, 22, 23mm

Set of 15pcs 3/8"dr. hex sockets + 3/8"dr. ratchet handle

CODE	Pc	CONTENT
FG 624B/S16	16	8, 9, 10, 11, 12, 13, 14, 15, 16, 17, 18, 19, 21, 22, 23mm FG 624/CR38



Set of 22pcs 3/8"dr. tools

CODE	Pz
FG 624B/S22	22

 **FG 624/B8,9,10,11,12,13,14,15
16,17,18,19,21,22,23mm**

 **FG 624/CR38**

 **FG 624B/PA75,125,150,250**

 **FG 624/ES38**

 **FG 624/SN38**

Soft form 22pcs 3/8"dr. tools

CODE	Pz
FG 100/19	22

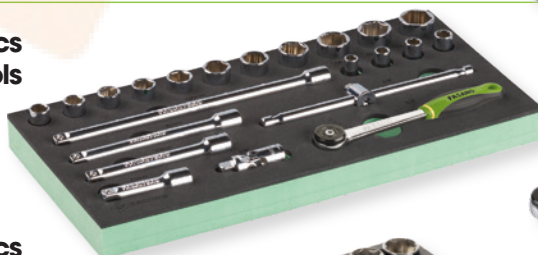



Rigid form 22pcs 3/8"dr. tools

CODE	Pz
FG 102/19	22



 **FG 624/B8,9,10,11,12,13,14,15
16,17,18,19,21,22,23mm**

 **FG 624/CR38**

 **FG 624B/PA75,100,125,250**

 **FG 624/ES38**

 **FG 624/SN38**

3/8"dr. HEXAGONAL SOCKET WRENCH -deep series

→ USE

hexagonal bolts

→ FINISH

mirror

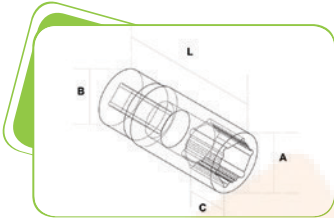

CODE	mm	A/mm	B/mm	D/mm	E/mm	
FG 624B/L8	8	12.2	17.5	7.1	54.0	
FG 624B/L9	9	13.2	17.5	7.1	54.0	
FG 624B/L10	10	14.8	17.5	7.9	54.0	
FG 624B/L11	11	16.2	17.5	9.7	54.0	
FG 624B/L12	12	17.5	17.5	9.9	54.0	
FG 624B/L13	13	17.8	17.8	10.7	54.0	
FG 624B/L14	14	19.8	18.6	10.7	61.0	
FG 624B/L15	15	20.3	19.5	10.7	61.0	
FG 624B/L16	16	21.8	20.2	10.7	61.0	
FG 624B/L17	17	23.8	21.8	11.2	67.0	
FG 624B/L18	18	24.8	23.5	11.2	67.0	
FG 624B/L19	19	25.8	24.0	12.2	67.9	
FG 624B/L21	21	27.8	26.4	12.4	67.0	
FG 624B/L22	22	29.8	27.2	13.0	73.0	
FG 624B/L23	23	31.5	28.8	13.2	73.0	



Set of 15pcs 3/8"dr. hex sockets

CODE	Pc	CONTENT
FG 624L/S15	15	8, 9, 10, 11, 12, 13, 14, 15, 16, 17, 18, 19, 21, 22, 23mm

Set of 15pcs 3/8"dr. hex sockets + 3/8"dr. ratchet handle

CODE	Pc	CONTENT
FG 624L/S16	16	8, 9, 10, 11, 12, 13, 14, 15, 16, 17, 18, 19, 21, 22, 23mm FG 624/CR38



Set of 20pcs 3/8"dr. tools

CÓDIGO	Pz	€/Pz
FG 624B/LS20	20	282,00

- FG 624B/L8,9,10,11,12,13,14,15
16,17,18,19,21,22,23mm
- FG 624/CR38
- FG 624B/PA75,125,150,250
- FG 624/ES38
- FG 624/SN38

Soft form 20pcs 3/8"dr. tools

CODE	Pz	
FG 100/18	20	

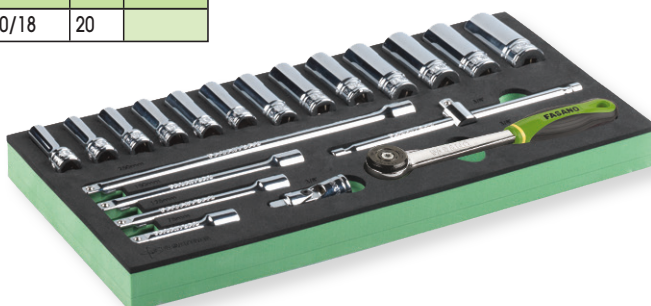

- FG 624B/L8,9,10,11,12,13,14,15
16,17,18,19,21,22,23mm
- FG 624/CR38
- FG 624B/PA75,100,125,250
- FG 624/ES38
- FG 624/SN38



3/8"dr 12PT SOCKET WRENCH

→ USE

Hex and 12PT bolts

→ FINISH

mirror

CODE	mm	A/mm	B/mm	D/mm	E/mm
FG 624/C6	6	12.2	20.0	32.0	5.0
FG 624/C7	7	13.5	20.0	32.0	5.0
FG 624/C8	8	12.2	20.0	32.0	5.0
FG 624/C9	9	13.5	20.0	32.0	5.0
FG 624/C10	10	14.7	20.0	32.0	6.0
FG 624/C11	11	16.0	20.0	32.0	7.0
FG 624/C12	12	17.2	20.0	32.0	8.0
FG 624/C13	13	18.5	20.0	32.0	8.0
FG 624/C14	14	19.8	20.0	32.0	10.0
FG 624/C15	15	21.0	21.0	35.0	10.0
FG 624/C16	16	22.2	23.0	35.0	10.0
FG 624/C17	17	23.8	24.0	35.0	10.0
FG 624/C18	18	24.8	24.0	35.0	12.0
FG 624/C19	19	26.0	24.0	35.0	12.0
FG 624/C20	20	26.0	24.0	35.0	12.0
FG 624/C21	21	28.5	27.0	35.0	12.0
FG 624/C22	22	29.7	28.0	38.0	14.0
FG 624/C24	24	31.5	28.8	38.0	14.0

Set of 18pcs 12PT socket wrenches on metal rail

CODE	Pc	CONTENT
FG 624C/S18	18	6, 7, 8, 9, 10, 11, 12, 13, 14, 15, 16, 17, 18, 19, 20, 21, 22, 24mm



Set of 22pcs 3/8"dr. tools

CODE	Pz
FG 624C/S22	22

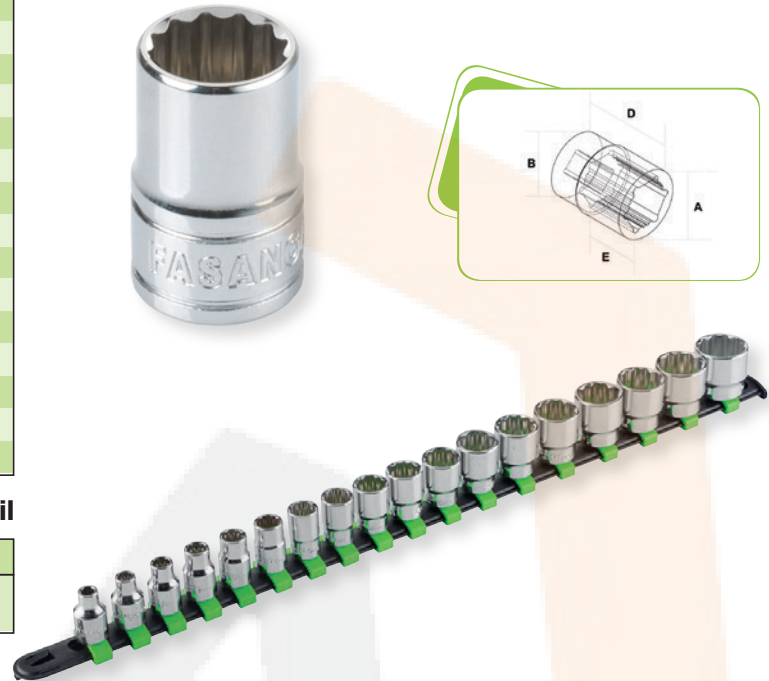

Soft form of 22pcs 3/8"dr. tools

CODE	Pz
FG 100/19B	22



Plastic tray of 22pcs 3/8"dr. tools

CODE	Pz
FG 102/19B	22



3/8"dr 12PT SOCKET WRENCH -série longue

→ USE

Hex and 12PT bolts

→ FINISH

mirror

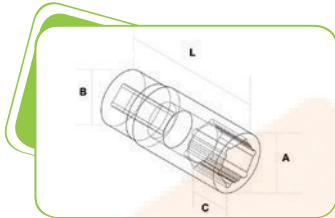

CODE	mm	A/mm	B/mm	D/mm	E/mm
FG 624/L6	6	12.2	17.5	7.1	54.0
FG 624/L7	7	13.2	17.5	7.1	54.0
FG 624/L8	8	12.2	17.5	7.1	54.0
FG 624/L9	9	13.2	17.5	7.1	54.0
FG 624/L10	10	14.8	17.5	7.9	54.0
FG 624/L11	11	16.2	17.5	9.7	54.0
FG 624/L12	12	17.5	17.5	9.9	54.0
FG 624/L13	13	17.8	17.8	10.7	54.0
FG 624/L14	14	19.8	18.6	10.7	61.0
FG 624/L15	15	20.3	19.5	10.7	61.0
FG 624/L16	16	21.8	20.2	10.7	61.0
FG 624/L17	17	23.8	21.8	11.2	67.0
FG 624/L18	18	24.8	23.5	11.2	67.0
FG 624/L19	19	25.8	24.0	12.2	67.9
FG 624/L20	20	26.0	26.4	12.4	67.0
FG 624/L21	21	27.8	26.4	12.4	67.0
FG 624/L22	22	29.8	27.2	13.0	73.0
FG 624/L24	24	31.5	28.8	13.2	73.0

Set of 18pcs 12PT socket wrenches

CODE	Pc	CONTENT
FG 624L/S18	18	6, 7, 8, 9, 10, 11, 12, 13, 14, 15, 16, 17, 18, 19, 20, 21, 22, 24mm



Set of 20pcs 3/8"dr. tools

CODE	Pz
FG 624L/S20	20



Soft form of 20pcs 3/8"dr. tools

CODE	Pz
FG 100/18B	20

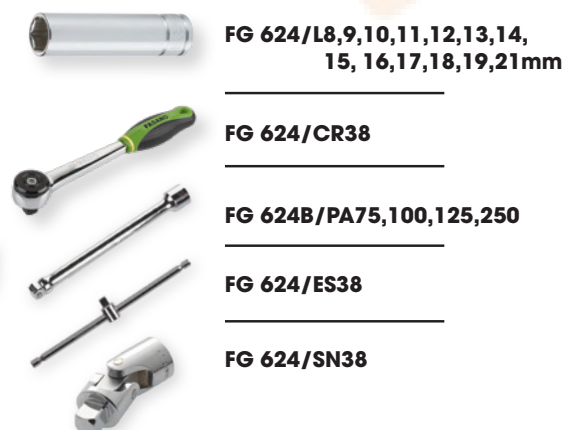
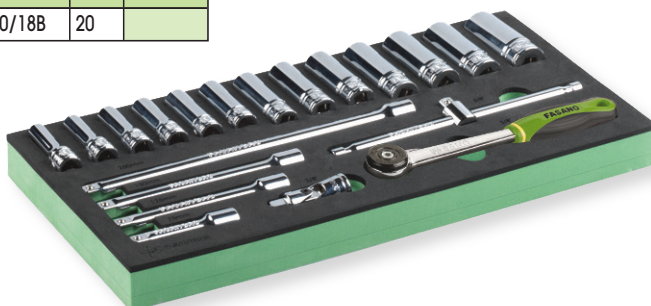

3/8"dr 12PT INCH SOCKET WRENCH

→ USE

Inch bolts

→ FINISH

mirror

CODE	"	A/mm	B/mm	D/mm	E/mm
FG 624C/IN1	1/4	12.2	20.0	32.0	5.0
FG 624C/IN2	5/16	12.2	20.0	32.0	5.0
FG 624C/IN3	11/32	13.5	20.0	32.0	5.0
FG 624C/IN4	3/8	14.7	20.0	32.0	6.0
FG 624C/IN5	7/16	16.0	20.0	32.0	7.0
FG 624C/IN6	15/32	17.2	20.0	32.0	8.0
FG 624C/IN7	1/2	18.5	20.0	32.0	8.0
FG 624C/IN8	9/16	19.8	20.0	32.0	10.0
FG 624C/IN9	19/32	21.0	21.0	35.0	10.0
FG 624C/IN10	5/8	22.2	23.0	35.0	10.0
FG 624C/IN11	11/16	23.8	24.0	35.0	10.0
FG 624C/IN12	3/4	26.0	24.0	35.0	12.0
FG 624C/IN13	25/32	26.0	24.0	35.0	12.0
FG 624C/IN14	13/16	28.5	27.0	35.0	12.0
FG 624C/IN15	7/8	29.7	28.0	38.0	14.0
FG 624C/IN16	15/16	31.5	28.8	38.0	14.0

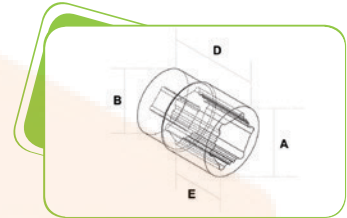

Set of 13pcs 12PT inch socket wrenches

CODE	Pc	CONTENT
FG 624C/INS13	13	1/4, 5/16, 11/32, 3/8, 7/16, 1/2, 9/16, 19/32, 5/8, 11/16, 3/4, 13/16, 7/8



Set of 23pcs 3/8"dr. tools

CODE	Pz
FG 624C/INS23	23

1/4, 5/16, 11/32, 3/8, 7/16, 15/32, 1/2, 9/16, 19/32, 5/8, 11/16, 3/4, 25/32, 13/16, 7/8, 15/16

FG 624/CR38

FG 624B/PA75,150,125,250

FG 624/ES38

FG 624/SN38

Soft form of 23pcs 3/8"dr. tools

CODE	Pz
FG 100/19IN	23

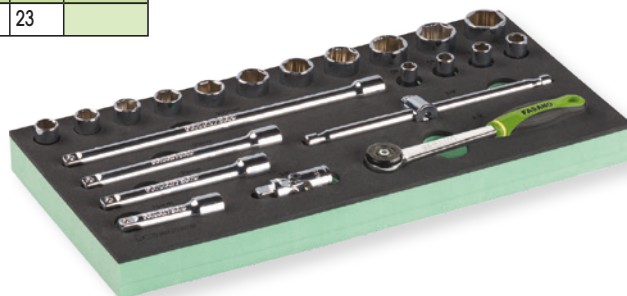

1/4, 5/16, 11/32, 3/8, 7/16, 15/32, 1/2, 9/16, 19/32, 5/8, 11/16, 3/4, 25/32, 13/16, 7/8, 15/16

FG 624/CR38

FG 624B/PA75,150,125,250

FG 624/ES38

FG 624/SN38

3/8"dr TORX SOCKET WRENCH

→ **USE**
Torx bolts

→ **FINISH**
mirror

CODE	mm	A/mm	B/mm	E/mm	L/mm
FG 624B/TX5	5	16.8	9.3	10.5	28.0
FG 624B/TX6	6	16.8	9.3	10.5	28.0
FG 624B/TX7	7	16.9	11.7	10.7	28.0
FG 624B/TX8	8	16.9	11.7	10.7	28.0
FG 624B/TX10	10	16.9	14.5	10.8	28.0
FG 624B/TX12	12	19.8	17.0	14.0	32.0
FG 624B/TX14	14	19.8	17.5	14.0	32.0
FG 624B/TX16	16	19.8	17.0	14.0	32.0

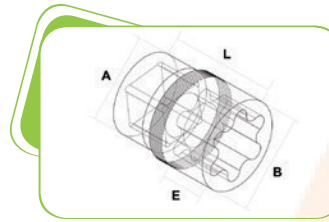

Set of 8pcs Torx socket wrenches

CODE	Pc	CONTENT
FG 624TX/S8	8	5, 6, 7, 8, 10, 12, 14, 16 E

3/8"dr TORX SOCKET WRENCH deep series

→ **USE**
Torx bolts

→ **FINISH**
mirror

CODE	mm	A/mm	B/mm	L/mm
FG 624L/TX6	6	16.8	10.0	63.0
FG 624L/TX7	7	16.8	10.9	63.0
FG 624L/TX8	8	16.8	12.0	63.0
FG 624L/TX10	10	16.8	14.9	63.0
FG 624L/TX12	12	16.8	15.8	63.0
FG 624L/TX14	14	16.8	16.8	63.0
FG 624L/TX16	16	17.8	17.8	63.0
FG 624L/TX18	18	17.8	19.8	63.0

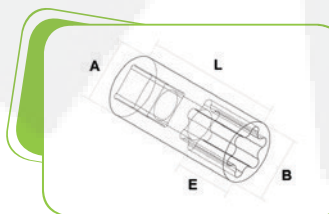

Set of 8pcs Torx socket wrenches

CODE	Pc	CONTENT
FG 624L/TXS8	8	6, 7, 8, 10, 12, 14, 16, 18 E

Set 10 3/8"dr. TORX socket wrenches - EXTRA LONG series

- Content:
E6, E7, E8, E10, E11, E12, E14, E16, E18, E20

CODE	Pz
FG 624B/TXS10	10

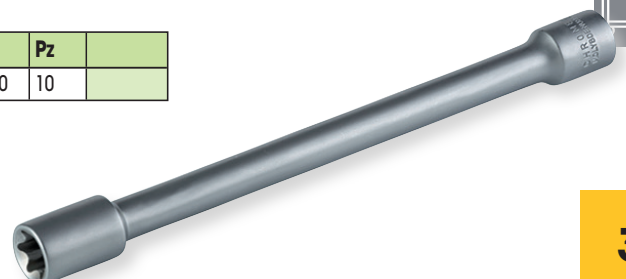

3/8"dr. Torx socket bits



CODE	TX	L/mm	
FG 149/TX9	9	50.0	
FG 149/TX10	10	50.0	
FG 149/TX15	15	50.0	
FG 149/TX20	20	50.0	

CODE	TX	L/mm	
FG 149/TX25	25	50.0	
FG 149/TX27	27	50.0	
FG 149/TX30	30	50.0	
FG 149/TX40	40	50.0	



Set of 8pcs 3/8"dr. Torx socket bits

CODE	Pc	CONTENT	
FG 149TX/S8	8	TX9, 10, 15, 20, 25, 27, 30, 40	



Set of 8pcs 3/8"dr. Torx socket bits

CODE	Pc	CONTENT	
FG 149TX/S8B	8	TX9, 10, 15, 20, 25, 27, 30, 40	



3/8"dr. hexagonal socket bits



CODE	mm	L/mm	
FG 149/H3	3	50.0	
FG 149/H4	4	50.0	
FG 149/H5	5	50.0	
FG 149/H6	6	50.0	

CODE	mm	L/mm	
FG 149/H7	7	50.0	
FG 149/H8	8	50.0	
FG 149/H10	10	50.0	



Set of 7pcs 3/8"dr. hexagonal socket bits

CODE	Pc	CONTENT	
FG 149H/S7	7	3,4,5,6,7,8,10	

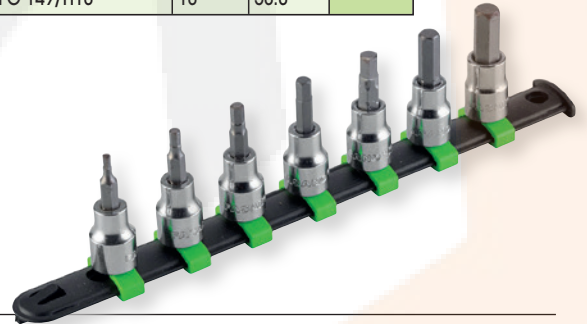

3/8"dr. socket bits for 5-star head screws



CODE	PT	L/mm	
FG 149/PT40	40	50.0	
FG 149/PT45	45	50.0	
FG 149/PT50	50	50.0	



3/8"dr. slotted socket bits



CODE	mm	L/mm	
FG 149/SL5.5	1.0x5.5	50.0	
FG 149/SL6.5	1.2x6.5	50.0	
FG 149/SL8	1.6x8.0	50.0	
FG 149/SL10	1.6x10.0	50.0	



3/8"dr. Phillips socket bits



CODE	PH	L/mm	
FG 149/PH1	1	50.0	
FG 149/PH2	2	50.0	
FG 149/PH3	3	50.0	
FG 149/PH4	4	50.0	



Set 8pcs 3/8" socket bits

CODE	Pz	
FG 149PF/S8	8	





3/8"dr. Reversible ratchet handle

CODE	■	
FG 624/CR38	3/8"	

- Ring-shaped inversion system integrated on the head
- 72 tooth mechanism
- Mirror finish
- Hook-in slot



3/8"dr. swivel drive with handle

CODE	L/mm	
FG 624/CS38	260	

Mango macho articulado con cuadrado de 3/8"

CODE	L/mm	
FG 624/Q38	425	

3/8"dr. swivel T-Handle

CODE	L/mm	
FG 624/ES38	220.0	



3/8" female and male drive wobble extension bar

CODE	L/mm	
FG 624B/PA75	75	
FG 624B/PA125	125	
FG 624B/PA150	150	
FG 624B/PA250	250	



3/8"dr. Universal joint

CODE	L/mm	
FG 624/SN38	52.0	



Set of 80pcs tools with 3/8" drive

CODE	CONTENT	
FG 624B/S80	80pz	



FG 624/B8,9,10,11,12,13,14,15,16,17,18,19,21,22,23



FG 624B/L8,10,13,17,19



FG 624/CR38



FG 625/SN38



FG 149/H3,4,5,6,7,8, 10
FG 149/TX9,10,15,20,25,27,30,40



FG 624/ES38



FG 624B/PA75,125,150,250



FG 600/B8,10,13,15,17,19



FG 89/50PI2 3/8"x1/4"



FG 85/25PH1, PH2, PH3, FG 85/25PZ1, PZ2, PZ3
FG 85/25SL3, SL4, SL4.5, SL5, SL5.5, SL6, L6.5
FG 85/H1.5, H2, 2.5, H3, H4, H5, H6
FG 85/25T9, T10, T15, T20, T25, T27, T30, T40
FG 88/60PI2



1/2"dr. HEXAGONAL SOCKET WRENCH

→ **USE**

hexagonal bolts

→ **FINISHING**

mirros

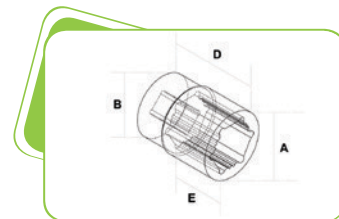

CODE	mm	A/mm	B/mm	D/mm	E/mm
FG 625/A8	8	14.9	21.8	38.1	7.5
FG 625/A9	9	16.5	21.8	38.1	8.0
FG 625/A10	10	14.9	21.8	38.1	7.5
FG 625/A11	11	16.5	21.8	38.1	8.0
FG 625/A12	12	18.2	21.8	38.1	9.1
FG 625/A13	13	19.0	21.8	38.1	9.1
FG 625/A14	14	20.5	21.8	38.1	10.7
FG 625/A15	15	22.2	22.6	38.1	10.7
FG 625/A16	16	23.8	22.6	38.1	10.7
FG 625/A17	17	24.5	22.9	38.1	12.7
FG 625/A18	18	25.4	23.7	38.1	13.9
FG 625/A19	19	26.3	24.8	38.1	14.0
FG 625/A20	20	27.1	26.1	38.1	14.0

CODE	mm	A/mm	B/mm	D/mm	E/mm
FG 625/A21	21	28.3	27.5	38.1	14.0
FG 625/A22	22	29.9	28.6	38.1	14.2
FG 625/A23	23	31.2	29.9	38.1	14.5
FG 625/A24	24	32.5	31.0	38.1	15.5
FG 625/A25	25	33.3	32.6	38.1	15.5
FG 625/A26	26	34.6	33.4	41.3	16.0
FG 625/A27	27	36.5	34.9	44.5	19.6
FG 625/A30	30	41.0	39.6	44.5	19.6
FG 625/A32	32	42.5	41.2	47.6	19.6

Set of 1/2"dr. hexagonal socket wrenches

CODE	Pc	CONTENT
FG 625A/S11	11	8,10,11,12,13,14,15,16,17,18,19
FG 625A/S10	10	20,21,22,23,24,25,26,27,30,32

Set 11pcs 1/2"dr. hexagonal sockets wrenches and ratchet handle

CODE	Pc	CONTENT
FG 625A/S12	12	8,10,11,12,13,14,15,16,17,18,19 + FG 625/CR12



Set of 25pcs 1/2"dr. tools

CODE	Pz
FG 625A/S25	25



- FG 625/A10,11,12,13,14,15,16,17,18, 19,20,21,22, 23,24,25,26,27,30,32mm
- FG 625/CR12
- FG 625/PA125, 250
- FG 625/ES12
- FG 625/SN12

Soft form of 25pcs 1/2"dr. tools

CODE	Pz
FG 100/21B	25



Plastic tray of 25pcs 1/2"dr. tools

CODE	Pz
FG 102/21B	25



FG 625/A10,11,12,13,14,15,16,17,18, 19,20,21,22, 23,24,25,26,27,30,32mm

FG 625/CR12

FG 625/PA125, 250

FG 625/ES12

FG 625/SN12

1/2"dr HEX SOCKET WRENCH -deep series

- USE
hexagonal bolts

- FINISHING
mirror

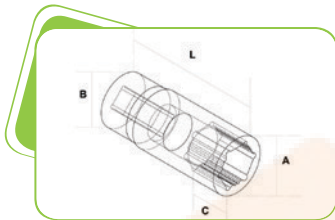

**Set of 37pcs
1/2"dr. tools**

CODE	Pz	
FG 625A/S37	37	



**FG 625/A8, 9, 10,11,12,13,
14,15,16,17, 18,19,20,21,22,23,
24,26, 27,30,32mm**



**FG 625L/A10,12,13,14,17,19,21,
22,24,27,30mm**



FG 625/CR12



FG 625/PA125, 250



FG 625/ES12



FG 625/SN12

CODE	mm	A/mm	B/mm	C/mm	L/mm
FG 625L/A10	10	15.4	22,0	20,0	76.8
FG 625L/A11	11	16.4	22,0	18,0	77,0
FG 625L/A12	12	18,0	22,0	20,0	76.8
FG625L/A13	13	19,0	22,0	19.4	77,0
FG 625L/A14	14	20.4	22,0	32.7	77,0
FG 625L/A15	15	21.9	20.9	34,0	76.3
FG 625L/A16	16	22,0	20.3	31.8	76.7
FG 625L/A17	17	24,0	22,0	31.5	77,0
FG 625L/A18	18	26,0	23,0	35.8	77.4
FG 625L/A19	19	26,0	24,0	31,0	77,0
FG 625L/A20	20	27.7	26.5	23,0	79.7
FG 625L/A21	21	27.8	26,0	31.7	77,0
FG 625L/A22	22	29.8	26,0	33,0	77,0
FG 625L/A23	23	31.5	28.8	23.6	72.9
FG 625L/A24	24	31.8	28,0	33,0	77,0
FG 625L/A25	25	33.2	31.7	23.4	80.2
FG 625L/A26	26	35,0	33.2	24,0	80.2
FG 625L/A27	27	35.8	31,0	31.5	77.1
FG 625L/A28	28	37.5	35.6	24,0	80.2
FG 625L/A29	29	37.8	34,0	31.4	77,0
FG 625L/A30	30	39.7	34,0	31.7	77,0
FG 625L/A32	32	43,0	40.9	27.3	80,0
FG 625L/A36	36	48,0	40,0	35,0	78,0

Set of 1/2"dr. hex socket wrenches

CODE	Pc	CONTENT
FG 625AL/S11	11	10,12,13,14,15,16,17,18,19,21,22mm
FG 625AL/S9	9	23,24,25,26,27,28,29,30,32

**Soft form of 37pcs
1/2"dr. tools**

CODE	Pz	
FG 100/21H	37	



**FG 625/A8, 9, 10,11,12,13,
14,15,16,17, 18,19,20,21,22,23,
24,26, 27,30,32mm**



**FG 625L/A10,12,13,14,17,19,21,
22,24,27,30mm**



FG 625/CR12



FG 625/PA125, 250



FG 625/ES12



FG 625/SN12



1/2"dr. 12PT SOCKET WRENCH

→ USE

hex and 12PT bolts

→ FINISHING

mirror

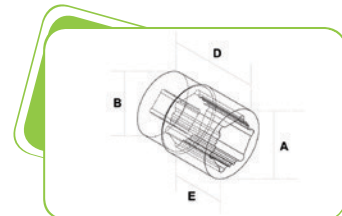

CODE	mm	C/mm	B/mm	D/mm	E/mm
FG 625/C8	8	14.9	21.8	38.1	7.5
FG 625/C9	9	16.5	21.8	38.1	8.0
FG 625/C10	10	14.9	21.8	38.1	7.5
FG 625/C11	11	16.5	21.8	38.1	8.0
FG 625/C12	12	18.2	21.8	38.1	9.1
FG 625/C13	13	19.0	21.8	38.1	9.1
FG 625/C14	14	20.5	21.8	38.1	10.7
FG 625/C15	15	22.2	22.6	38.1	10.7
FG 625/C16	16	23.8	22.6	38.1	10.7
FG 625/C17	17	24.5	22.9	38.1	12.7
FG 625/C18	18	25.4	23.7	38.1	13.9
FG 625/C19	19	26.3	24.8	38.1	14.0
FG 625/C20	20	27.1	26.1	38.1	14.0

CODE	mm	A/mm	B/mm	D/mm	E/mm
FG 625/C21	21	28.3	27.5	38.1	14.0
FG 625/C22	22	29.9	28.6	38.1	14.2
FG 625/C23	23	31.2	29.9	38.1	14.5
FG 625/C24	24	32.5	31.0	38.1	15.5
FG 625/C25	25	33.3	32.6	38.1	15.5
FG 625/C26	26	34.6	33.4	41.3	16.0
FG 625/C27	27	36.5	34.9	44.5	19.6
FG 625/C28	28	41.0	39.6	44.5	19.6
FG 625/C29	29	42.5	41.2	47.6	19.6
FG 625/C30	30	41.0	39.6	44.5	19.6
FG 625/C32	32	42.5	41.2	47.6	19.6

Set of 1/2"dr. 12PT socket wrenches

CODE	Pz	CONTENT
FG 625/S11	11	8,10,11,12,13,14,15,16,17,18,19
FG 625/S12B	12	20,21,22,23,24,25,26,27,28,29,30,32

Set 11pcs 1/2"dr. 12PT sockets wrenches and ratchet handle

CODE	Pz	CONTENT
FG 625/S12	12	8,10,11,12,13,14,15,16,17,18,19 + FG 625/CR12



Set of 25pcs 1/2"dr. tools

CODE	Pz
FG 625/S25	25

FG 625/C10,11,12,13,14,15,16,17,18,19,20,21,22, 23,24,25,26,27,30,32mm

FG 625/CR12

FG 625/PA125, 250

FG 625/ES12

FG 625/SN12

Soft form of 25pcs 1/2"dr. tools

CODE	Pz
FG 100/21C	25



Plastic tray of 25pcs 1/2"dr. tools

CODE	Pz
FG 102/21C	22



FG 625/C10,11,12,13,14,15,16,17,18,19,20,21,22, 23,24,25,26,27,30,32mm

FG 625/CR12

FG 625/PA125, 250

FG 625/ES12

FG 625/SN12

1/2"dr. 12PT SOCKET WRENCH - deep series

- USE

hex and 12PT bolts

- FINISHING

mirror

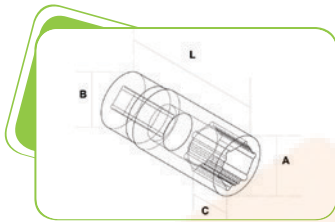

Set of 37pcs 1/2"dr. tools

CODE	Pz	
FG 625/S37	37	



FG 625/C8, 9, 10,11,12,13, 14,15,16,17, 18,19,20,21,22,23, 24,26, 27,30,32mm



FG 625/L10,12,13,14,17,19,21, 22,24,27,30mm



FG 625/CR12



FG 625/PA125, 250



FG 625/ES12



FG 625/SN12

CODE	mm	A/mm	B/mm	C/mm	L/mm
FG 625/L8	8	13,0	21,9	16,7	77,0
FG 625/L9	9	14,0	21,9	17,0	77,0
FG 625/L10	10	15,5	21,9	19,5	77,0
FG 625/L11	11	16,5	21,9	17,6	77,0
FG 625/L12	12	17,7	21,9	19,0	77,0
FG 625/L13	13	19,0	21,9	19,0	77,0
FG 625/L14	14	20,4	21,9	33,0	77,0
FG 625/L15	15	21,9	20,5	31,5	77,0
FG 625/L16	16	22,0	20,5	31,7	77,0
FG 625/L17	17	23,9	22,0	32,0	77,0
FG 625/L18	18	26,0	23,0	31,0	77,0
FG 625/L19	19	26,0	24,0	35,6	77,0
FG 625/L20	20	27,7	25,7	31,6	77,0
FG 625/L21	21	27,6	26,0	35,5	77,0
FG 625/L22	22	29,7	26,0	32,0	77,0
FG 625/L23	23	31,8	27,7	31,0	77,0
FG 625/L24	24	31,8	28,0	32,4	77,0
FG 625/L25	25	33,8	29,7	31,6	77,0
FG 625/L27	27	35,8	30,7	31,3	77,0
FG 625/L30	30	39,8	33,8	31,3	77,0
FG 625/L32	32	42,0	35,0	31,6	77,0
FG 625/L36	36	48,0	40,0	35,0	77,5

Set of 1/2"dr. 12pt socket wrenches

CODE	Pc	CONTENT
FG 625L/S12	12	8,9,10,11,12,13,14,15,16,17,18,19mm
FG 625L/S6	6	21,22,24,27,30,32

Soft form of 37pcs 1/2"dr. tools

CODE	Pz	
FG 100/21L	37	



FG 625/C8, 9, 10,11,12,13, 14,15,16,17, 18,19,20,21,22,23, 24,26, 27,30,32mm



FG 625/L10,12,13,14,17,19,21, 22,24,27,30mm



FG 625/CR12



FG 625/PA125, 250



FG 625/ES12



FG 625/SN12



1/2"dr. 12PT INCH SOCKET WRENCH

→ USE

hex and 12PT
inch bolts

→ FINISHING

mirror

CODE	"	A/mm	B/mm	D/mm	E/mm
FG 625C/IN1	5/16	14.9	21.8	38.1	7.5
FG 625C/IN2	3/8	14.9	21.8	38.1	7.5
FG 625C/IN3	7/16	16.5	21.8	38.1	8.0
FG 625C/IN4	15/32	18.2	21.8	38.1	9.1
FG 625C/IN5	1/2	19.0	21.8	38.1	10.7
FG 625C/IN6	9/16	20.5	21.8	38.1	10.7
FG 625C/IN7	19/32	22.2	22.6	38.1	10.7
FG 625C/IN8	5/8	23.8	22.6	38.1	12.7
FG 625C/IN9	11/16	24.5	22.9	38.1	12.7
FG 625C/IN10	3/4	26.3	24.8	38.1	14.0
FG 625C/IN11	25/32	27.1	26.12	38.21	14.0
FG 625C/IN12	13/16	28.3	27.5	38.1	14.0
FG 625C/IN13	7/8	29.9	28.6	38.1	14.2

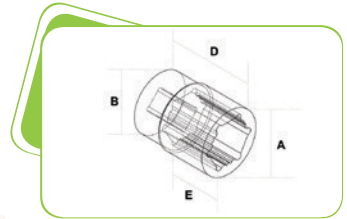

CODE	"	A/mm	B/mm	D/mm	E/mm	€/Pz
FG 625C/IN14	15/16	32.5	31.0	38.1	15.5	
FG 625C/IN15	1	33.3	32.6	38.1	15.5	
FG 625C/IN16	1.1/16	36.5	34.9	44.5	19.6	
FG 625C/IN17	1.1/8	36.5	34.9	44.5	19.6	
FG 625C/IN18	1.3/16	41.0	39.6	44.5	19.6	
FG 625C/IN19	1.1/4	42.5	41.2	47.6	19.6	

Set of 11pcs 1/2"dr. 12PT inch sockets

CODE	Pz	CONTENT
FG 625IN/S11	11	3/8, 7/16, 1/2, 9/16, 5/8, 11/16, 3/4, 13/16, 7/8, 15/16, 1"



Set of 24pcs 1/2"dr. tools

CODE	Pz
FG 625IN/S24	24

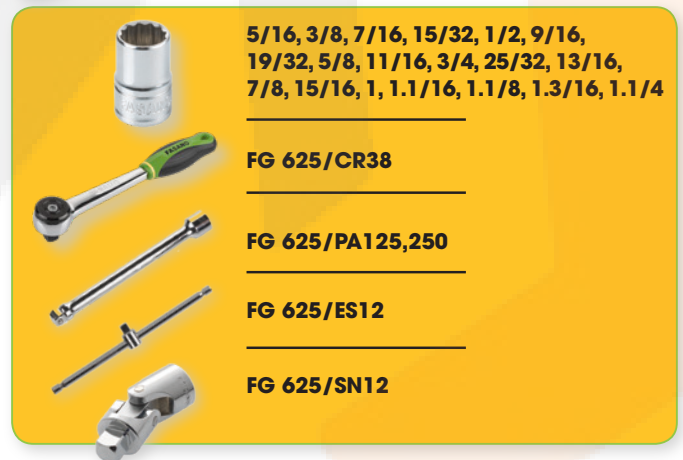

Soft form of 24pcs 1/2"dr. tools

CODE	Pz
FG 100/21IN	24

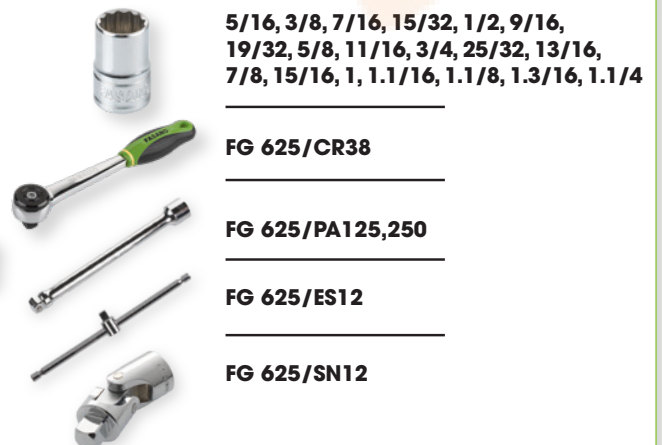

1/2"dr. UNIVERSAL SOCKET WRENCH

- USE

Hexagonal bolts (intact and rounded off until **50%**), TORX, XZN, 12points and Square bolts

CODE	mm	E	■	B/mm	C/mm	L/mm
FG 626/A8	8	E10		13.5	21.9	38.1
FG 626/A10	10	E12	8	15.6	21.9	38.1
FG 626/A11	11	E14		16.7	21.9	38.1
FG 626/A12	12	E16	10	18.0	21.9	38.1
FG 626/A13	13	E18	11	19.1	21.9	38.1
FG 626/A14	14		12	20.8	22.0	38.1
FG 626/A15	15			23.0	22.0	38.1
FG 626/A16	16	E20		24.0	22.0	38.1
FG 626/A17	17		13	24.5	22.0	38.1
FG 626/A18	18	E22	15	26.0	23.0	38.1
FG 626/A19	19	E24	16	27.5	24.0	38.1
FG 626/A20	20			28.5	24.0	38.1
FG 626/A21	21			28.5	24.0	38.1

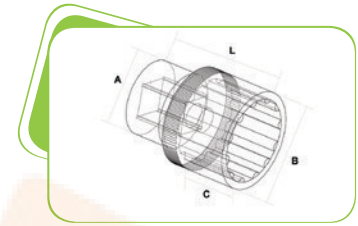

CODE	mm	E	■	B/mm	C/mm	L/mm
FG 626/A22	22	E28		30.5	24.0	38.1
FG 626/A23	23			28.5	24.0	38.1
FG 626/A24	24	E30		32.5	25.0	40.0
FG 626/A27	27	E32		37.0	28.0	42.0
FG 626/A30	30			41.8	29.0	45.0
FG 626/A32	32			43.8	30.0	45.0



Set of 1/2"dr. UNIVERSAL inch sockets

CODE	Pc	CONTENT
FG 626/S13	13	8,10,11,12,13,14,15,16,17,18,19,20,21 mm
FG 626/S6	6	22, 23, 24, 27, 30, 32 mm



Set of 23pcs 1/2"dr. tools

CODE	Pz
FG 626/S23	23

FG 626/A8,10,11,12,13,14,15,16, 17,18,19,20,21,22,24,27,30,32mm

FG 625/CR12

FG 625/PA125, 250

FG 625/ES12

FG 625/SN12

Soft form of 23pcs 1/2"dr. tools

CODE	Pz
FG 100/20B	23



FG 626/A8,10,11,12,13,14,15,16, 17,18,19,20,21,22,24,27,30,32mm

FG 625/CR12

FG 625/PA125, 250

FG 625/ES12

FG 625/SN12



1/2"dr. TORX SOCKET WRENCH

→ USE

Torx bolts

→ FINISHING

mirror



CODE	E	A/mm	B/mm	L/mm	
FG 625/TX8	8	21.8	17.8	38.1	
FG 625/TX10	10	21.8	15.4	38.1	
FG 625/TX12	12	21.8	17.8	38.1	
FG 625/TX14	14	21.8	20.4	38.1	
FG 625/TX16	16	21.8	21.8	38.1	
FG 625/TX18	18	21.8	21.8	38.1	
FG 625/TX20	20	22.8	22.8	38.1	
FG 625/TX22	22	24.0	25.8	38.1	
FG 625/TX24	24	26.0	27.8	40.0	

Set of 9pcs 1/2"dr. Torx socket wrenches

CODE	Pc	CONTENT	
FG 625TX/S9	9	8, 10, 12, 14, 16, 18, 20, 22, 24 E	

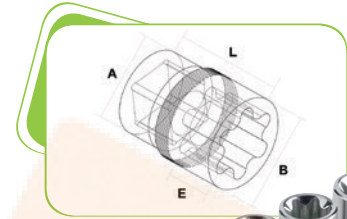

1/2"dr. TORX SOCKET WRENCH

→ USE

Torx bolts

→ FINISHING

mirror



CODE	E	A/mm	B/mm	L/mm	€/Pz
FG 625L/TX8	8	21.8	11.8	77.0	
FG 625L/TX10	10	21.8	15.4	77.0	
FG 625L/TX12	12	21.8	17.8	77.0	
FG 625L/TX14	14	21.8	20.4	77.0	
FG 625L/TX16	16	21.8	21.8	77.0	
FG 625L/TX18	18	21.8	21.8	77.0	
FG 625L/TX20	20	23.8	23.8	77.0	
FG 625L/TX22	22	24.0	25.8	77.0	
FG 625L/TX24	24	26.0	27.8	77.0	

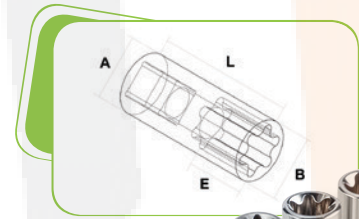

Set of 9pcs 1/2"dr. Torx socket wrenches

CODE	Pc	CONTENT	
FG 625LTX/S9	9	8, 10, 12, 14, 16, 18, 20, 22, 24 E	

Soft form of
44 TORX tools

CODE	Pz	
FG 100/21TX	44	

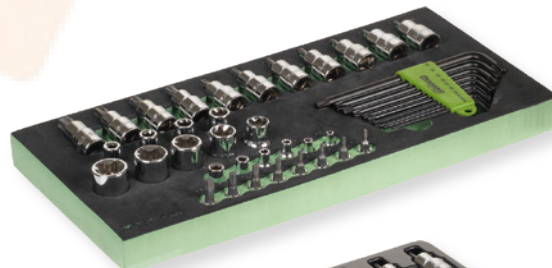

Plastic tray of
44 TORX tools

CODE	Pz	
FG 102/21TX	44	



 FG 624/TX4 - TX10

 FG 625/TX8 - TX24

 FG 147/TX9 - TX40

 FG 150/TX10 - TX60

 FG 139/C



1/2"dr. TORX SOCKET BIT

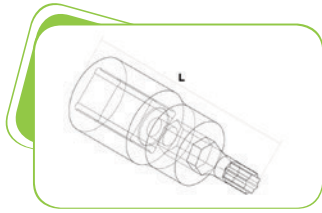

CODE	TX	L/mm
FG 150/TX6	6	55
FG 150/TX7	7	55
FG 150/TX8	8	55
FG 150/TX9	9	55
FG 150/TX10	10	55
FG 150/TX15	15	55
FG 150/TX20	20	55
FG 150/TX25	25	55
FG 150/TX27	27	55
FG 150/TX30	30	55
FG 150/TX40	40	55
FG 150/TX45	45	55
FG 150/TX50	50	55
FG 150/TX55	55	55
FG 150/TX60	60	55
FG 150/TX70	70	55

CODE	TX	L/mm
FG 150L/TX20	20	100
FG 150L/TX25	25	100
FG 150L/TX27	27	100
FG 150L/TX30	30	100
FG 150L/TX40	40	100
FG 150L/TX45	45	100
FG 150L/TX50	50	100
FG 150L/TX55	55	100
FG 150L/TX60	60	100
FG 150L/TX70	70	100

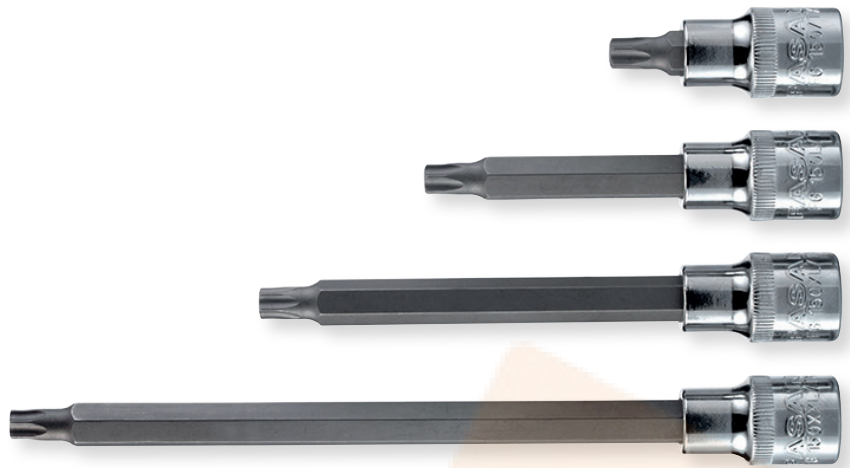

XL

CODE	TX	L/mm
FG 150XL/TX40	40	140
FG 150XL/TX45	45	140
FG 150XL/TX50	50	140
FG 150XL/TX55	55	140
FG 150XL/TX60	60	140
FG 150XL/TX70	70	140

XXL

CODE	TX	L/mm
FG 150XXL/TX40	40	200
FG 150XXL/TX45	45	200
FG 150XXL/TX50	50	200
FG 150XXL/TX55	55	200
FG 150XXL/TX60	60	200
FG 150XXL/TX70	70	200

Set of 11pcs 1/2"dr. Torx socket bits

CODE	Pz	CONTENT	€/Pz
FG 150TX/S11	11	TX10, TX15, TX20, TX25, TX27, TX30, TX40, TX45, TX50, TX55, TX60	XXXX



Set of 6pcs 1/2"dr. Torx socket bits

CODE	Pc	CONTENT
FG 150LTX/S6	6	TX30, TX40, TX45, TX50, TX55, TX60

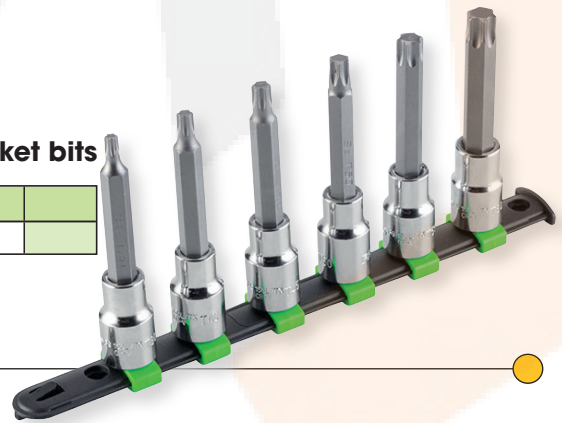

Set of 32pcs TORX socket bits - 1/2"

CODE
FG 150TX/S32

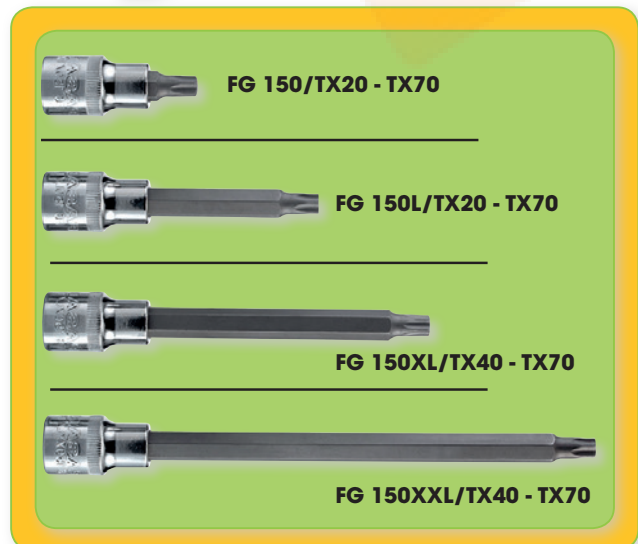





Set 1/2"dr. and 1/4"dr. TX sockets + TX socket bits

CODE	Pz	
FG 625TX/S23	23	

-  **FG 624/TX4, TX5, TX6, TX7, TX8, TX10**

-  **FG 625/TX12, TX14, TX16, TX18, TX20, TX22, TX24**

-  **FG 150/TX10, TX15, TX20, TX25, TX27, TX30, TX40**

-  **FG 625/CR12**

-  **FG 625/PA125**





Set 1/2"dr. TX sockets + TX socket bits

CODE	Pz	
FG 625TX/S9B	9	



-  **FG 625/TX10, TX12, TX14, TX16, TX18**

-  **FG 150/TX25, TX27, TX30, TX40**



Set of 13pcs swivel Torx sockets

CODE	Pz	CONTENT	
FG 625TX/S13	13	1/4": E4,E5,E6,E7,E8 3/8": E10,E12,E14,E16 1/2": E18,E20,E22,E24	



NEW



1/2"dr. XZN SOCKET BIT

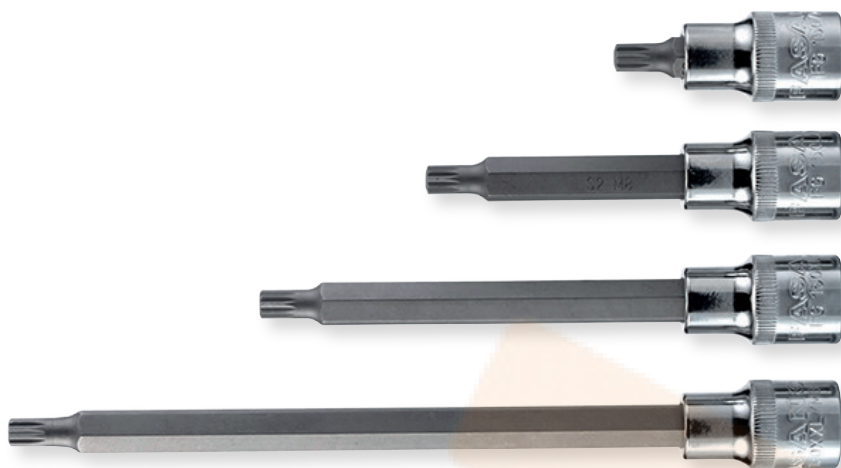
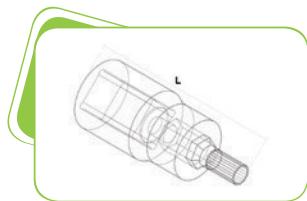

CODE	M	L/mm
FG 150/M5	5	55
FG 150/M6	6	55
FG 150/M8	8	55
FG 150/M9	9	55
FG 150/M10	10	55
FG 150/M12	12	55
FG 150/M14	14	55
FG 150/M16	16	55

CODE	M	L/mm
FG 150L/M5	5	100
FG 150L/M6	6	100
FG 150L/M8	8	100
FG 150L/M9	9	100
FG 150L/M10	10	100
FG 150L/M12	12	100
FG 150L/M14	14	100

XL

CODE	M	L/mm
FG 150XL/M5	5	140
FG 150XL/M6	6	140
FG 150XL/M8	8	140
FG 150XL/M9	9	140
FG 150XL/M10	10	140
FG 150XL/M12	12	140
FG 150XL/M14	14	140

XXL

CÓDIGO	M	L/mm	€/Pz
FG 150XXL/M8	8	200	XXXX
FG 150XXL/M10	10	200	XXXX
FG 150XXL/M12	12	200	XXXX
FG 150XXL/M14	14	200	XXXX



Set of 7pcs 1/2"dr. XZN socket bits

CODE	Pc	CONTENT
FG 150M/S7	7	M5, M6, M8, M10, M12, M14, M16

Set of 7pcs 1/2"dr. XZN socket bits

CODE	Pc	CONTENT
FG 150LM/S7	7	LM5, LM6, LM8, LM9, LM10, LM12, LM14

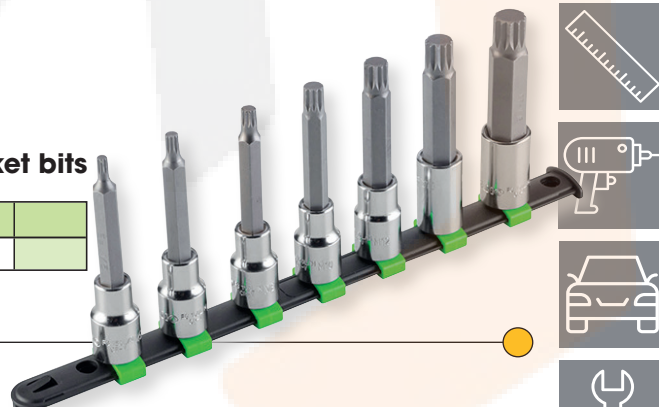
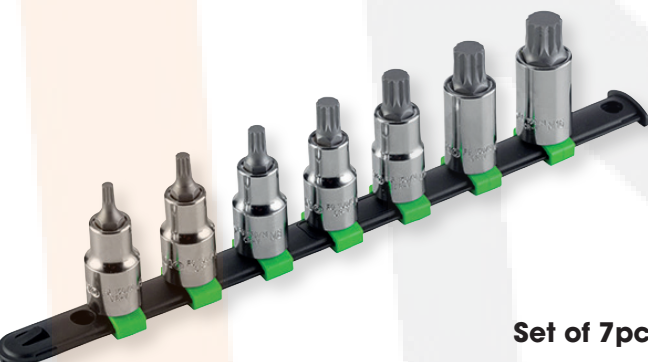

Set 1/2"dr. 26pcs socket bits - XZN

CODE
FG 150M/S26

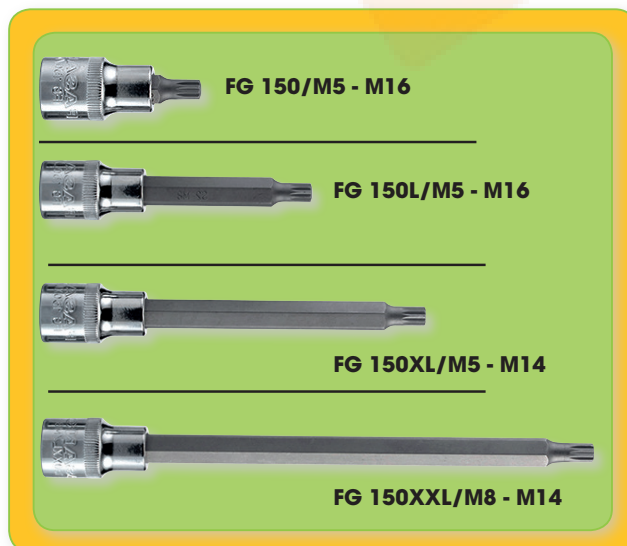

1/2"dr. RIBE SOCKET BIT

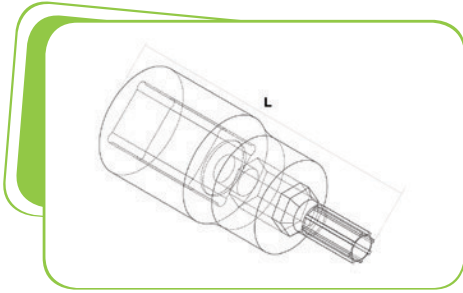

CODE	R	L/mm	
FG 150/R4	4	55	
FG 150/R5	5	55	
FG 150/R6	6	55	
FG 150/R7	7	55	
FG 150/R8	8	55	

CODE	R	L/mm	
FG 150/R9	9	55	
FG 150/R10	10	55	
FG 150/R11	11	55	
FG 150/R12	12	55	
FG 150/R13	13	55	
FG 150/R14	14	55	

Set of 11 pcs 1/2"dr. RIBE socket bits on plastic rail

CODE	Pc	CONTENT	
FG 150R/S11	11	R4, R5, R6, R7, R8, R9, R10, R11, R12, R13, R14	

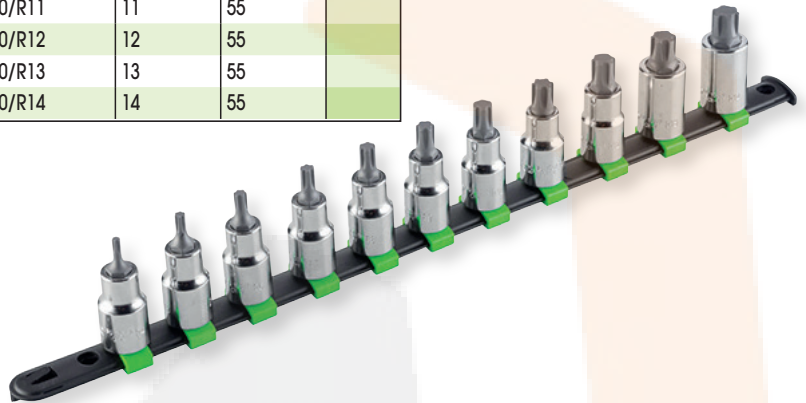

1/2"dr. RIBE SOCKET BIT long series

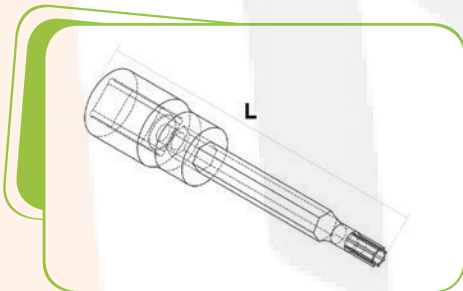

CODE	R	L/mm	
FG 150L/R4	4	100	
FG 150L/R5	5	100	
FG 150L/R6	6	100	
FG 150L/R7	7	100	
FG 150L/R8	8	100	

CODE	R	L/mm	
FG 150L/R9	9	100	
FG 150L/R10	10	100	
FG 150L/R11	11	100	
FG 150L/R12	12	100	
FG 150L/R13	13	100	
FG 150L/R14	14	100	

Form of 22pcs 1/2"dr. RIBE socket bits

CODE	Pc	CONTENT	
FG 100/82B	22	R4 - R14 LR4 - LR14	

Plastic tray of 22pcs 1/2"dr. RIBE socket bits

CODE	Pc	CONTENT	
FG 102/21R	22	R4 - R14 LR4 - LR14	



1/2"dr. SOCKET BIT FOR HOLED RIBE BOLTS

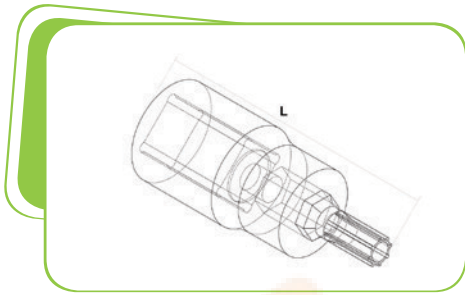

CODE	R	L/mm	
FG 150/RF4	4	55	
FG 150/RF5	5	55	
FG 150/RF6	6	55	
FG 150/RF7	7	55	
FG 150/RF8	8	55	

CODE	R	L/mm	
FG 150/RF9	9	55	
FG 150/RF10	10	55	
FG 150/RF11	11	55	
FG 150/RF12	12	55	
FG 150/RF13	13	55	
FG 150/RF14	14	55	

Set of 11 pcs 1/2"dr. RIBE socket bits on plastic rail

CODE	Pc	CONTENT	
FG 150RF/S11	11	RF4 - RF14	

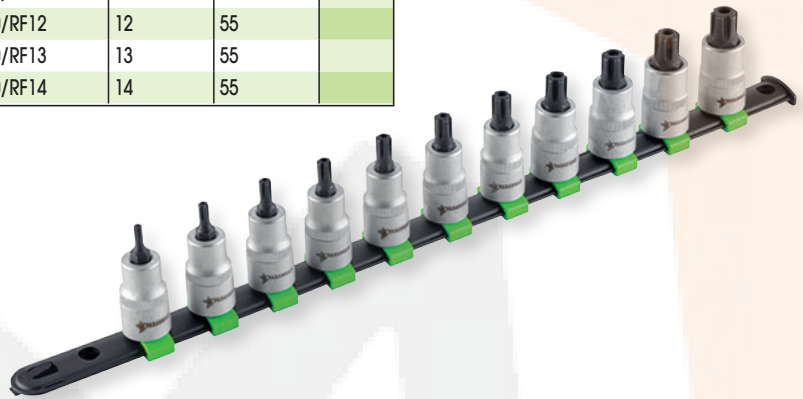

1/2"dr. SOCKET BIT FOR HOLED RIBE BOLTS long series

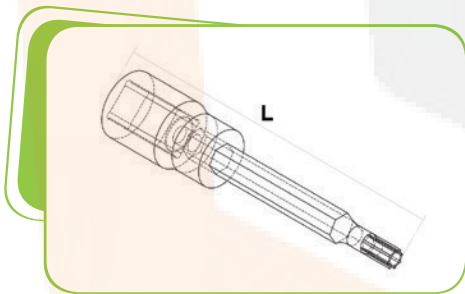

CODE	R	L/mm	
FG 150L/RF4	4	100	
FG 150L/RF5	5	100	
FG 150L/RF6	6	100	
FG 150L/RF7	7	100	
FG 150L/RF8	8	100	

CODE	R	L/mm	
FG 150L/RF9	9	100	
FG 150L/RF10	10	100	
FG 150L/RF11	11	100	
FG 150L/RF12	12	100	
FG 150L/RF13	13	100	
FG 150L/RF14	14	100	

Form of 11 pcs 1/2"dr. RIBE socket bits on metal rail

CODE	Pc	CONTENT	
FG 100/83B	22	RF4 - RF14 LRF4 - LRF14	

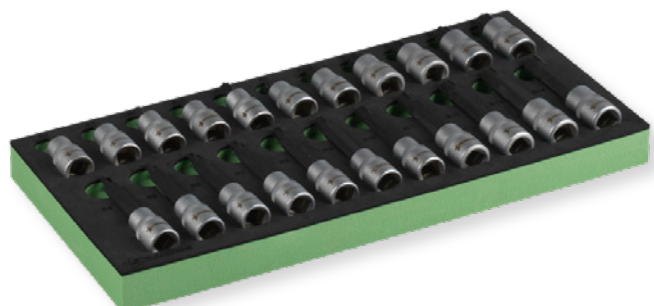

1/2"dr. HEX SOCKET BIT

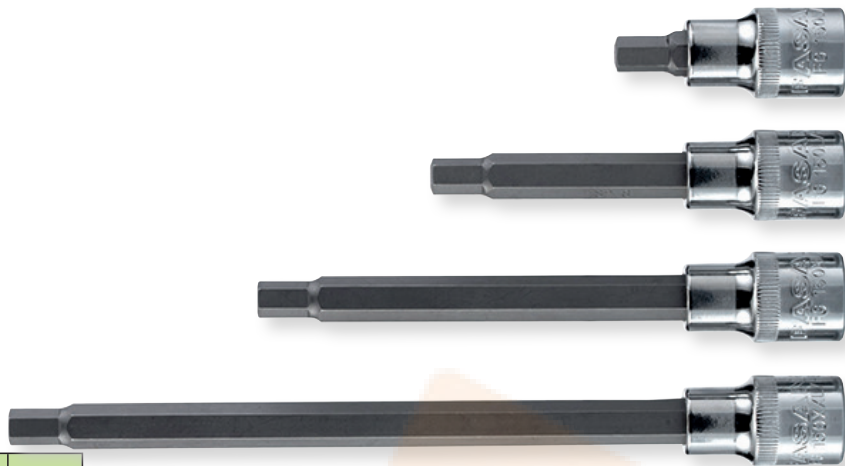
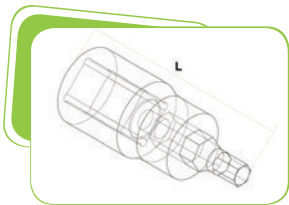

CODE	mm	L/mm
FG 150/H2	2	55
FG 150/H2.5	2.5	55
FG 150/H3	3	55
FG 150/H4	4	55
FG 150/H5	5	55
FG 150/H6	6	55
FG 150/H8	8	55
FG 150/H10	10	55
FG 150/H12	12	55
FG 150/H14	14	55
FG 150/H17	17	55
FG 150/H19	19	55

CODE	mm	L/mm
FG 150L/H2	2	100
FG 150L/H2.5	2.5	100
FG 150L/H3	3	100
FG 150L/H4	4	100
FG 150L/H5	5	100
FG 150L/H6	6	100
FG 150L/H7	7	100
FG 150L/H8	8	100
FG 150L/H10	10	100
FG 150L/H11	11	100
FG 150L/H12	12	100
FG 150L/H13	13	100



CODE	mm	L/mm
FG 150XL/H5	5	140
FG 150XL/H6	6	140
FG 150XL/H7	7	140
FG 150XL/H8	8	140
FG 150XL/H10	10	140
FG 150XL/H12	12	140
FG 150XL/H14	14	140



CODE	mm	L/mm
FG 150XXL/H5	5	200
FG 150XXL/H6	6	200
FG 150XXL/H7	7	200
FG 150XXL/H8	8	200
FG 150XXL/H10	10	200
FG 150XXL/H12	12	200

Set of 12pcs 1/2"dr. hex socket bits

CODE	Pc	CONTENT
FG 150H/S12	12	2, 2.5, 3, 4, 5, 6, 8, 10, 12, 14, 17, 19mm

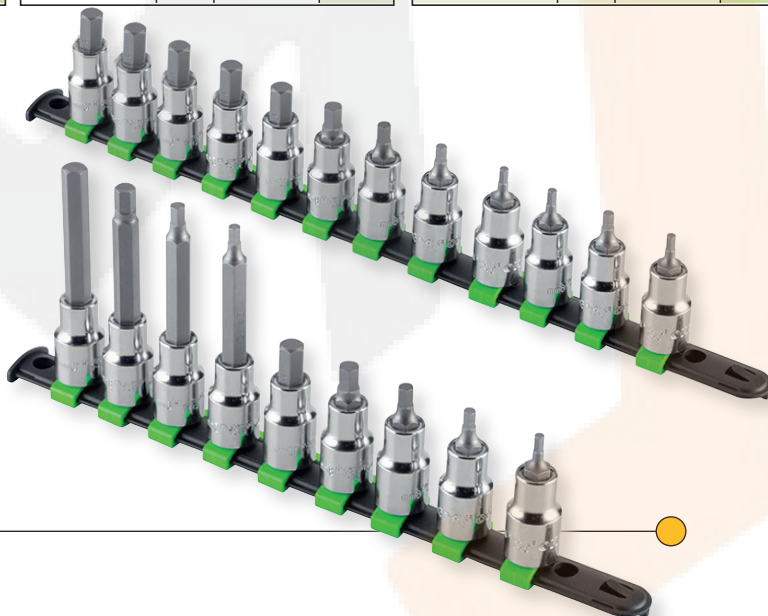

Set of 9pcs 1/2"dr. hex socket bits

CODE	Pc	CONTENT
FG 150H/S9	9	4, 5, 6, 8, 10, 5L, 6L, 8L, 10L mm



Set of 30pcs hex socket bits - 1/2"

CODE
FG 150H/S30

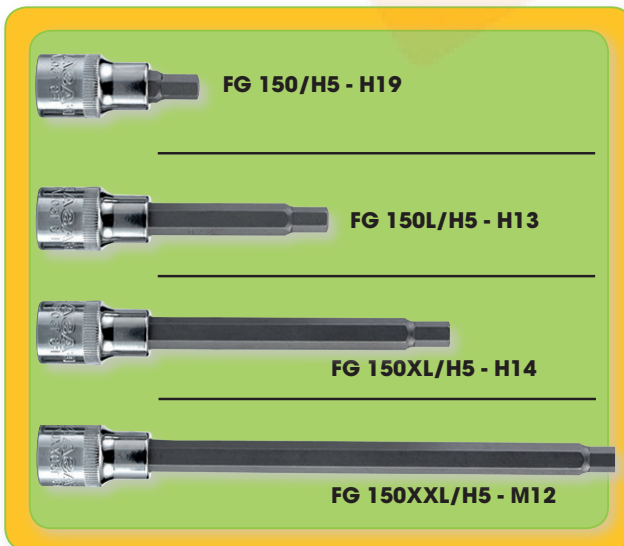

FG 150/H5 - H19

FG 150L/H5 - H13

FG 150XL/H5 - H14

FG 150XXL/H5 - M12

1/2"dr. HEX SOCKET BIT WITH BALL HEAD

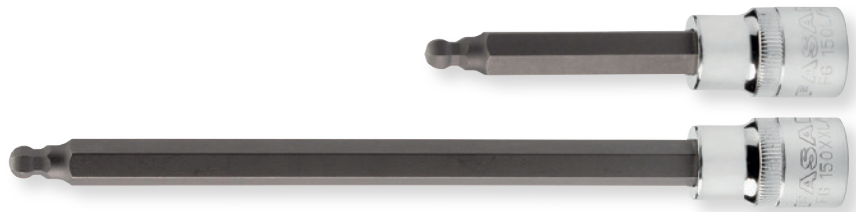
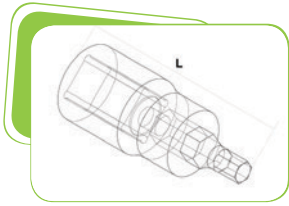

NEW

CODE	mm	L/mm	
FG 150L/H5B	5	100	
FG 150L/H6B	6	100	
FG 150L/H7B	7	100	
FG 150L/H8B	8	100	
FG 150L/H10B	10	100	

CODE	mm	L/mm	
FG 150XXL/H5B	5	200	
FG 150XXL/H6B	6	200	
FG 150XXL/H7B	7	200	
FG 150XXL/H8B	8	200	
FG 150XXL/H10B	10	200	

Set of 1/2" socket bits with ball head

CODE	Pz	CONTENT	
FG 150H/S10B	10	5L,6L,7L,8L,10L,5XXL,6XXL,7XXL,8XXL,10XXL	



1/2"dr. XZN socket bit



CODE	mm	L/mm	
FG 152/RM5	5	60	
FG 152/RM6	6	60	
FG 152/RM8	8	60	
FG 152/RM9	9	60	
FG 152/RM10	10	78	
FG 152/RM12	12	78	
FG 152/RM14	14	78	
FG 152/RM16	16	78	
FG 152/RM18	18	78	

Set of 9pcs 1/2"dr. XZN socket bits

RM5, RM6, RM8, RM9, RM10, RM12, RM14, RM16, RM18

CODE	Pz	
FG 152RM/S9	9	

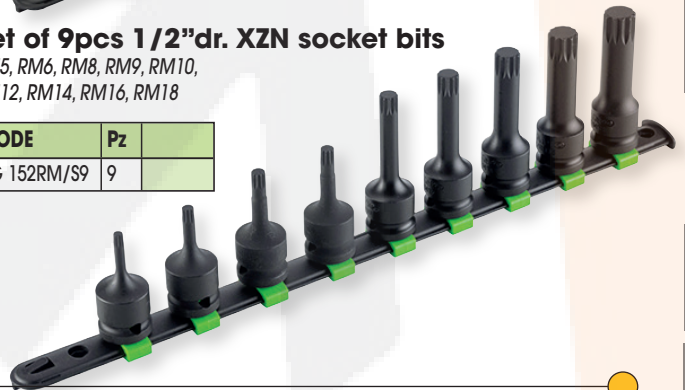

1/2"dr. hex socket bit



CODE	mm	L/mm	
FG 152/RH5	5	60	
FG 152/RH6	6	60	
FG 152/RH7	7	60	
FG 152/RH8	8	60	
FG 152/RH10	10	68	
FG 152/RH12	12	68	
FG 152/RH14	14	78	
FG 152/RH17	17	78	
FG 152/RH19	19	78	

Set of 9pcs 1/2"dr. hex socket bits

RH5, RH6, RH7, RH8, RH10, RH12, RH14, RH17, RH19

CODE	Pz	
FG 152RH/S9	9	

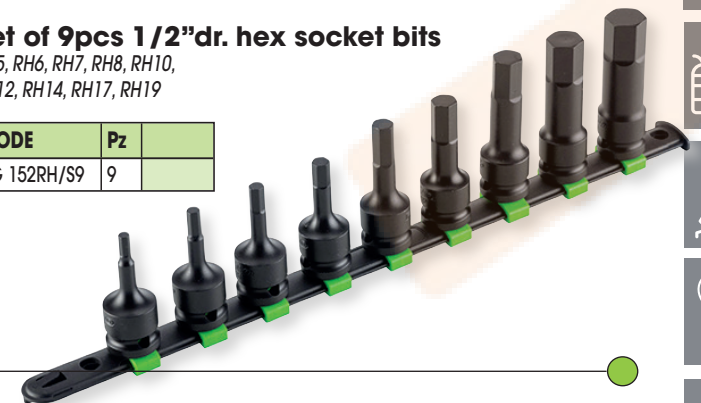

1/2"dr. Torx socket bit



CODE	mm	L/mm	
FG 152/RTX20	20	60	
FG 152/RTX25	25	60	
FG 152/RTX27	27	60	
FG 152/RTX30	30	60	
FG 152/RTX40	40	60	
FG 152/RTX45	45	68	
FG 152/RTX50	50	68	
FG 152/RTX55	55	68	
FG 152/RTX60	60	68	
FG 152/RTX70	70	78	

Set of 10pcs 1/2"dr. Torx socket bits

RTX20, RTX25, RTX27, RTX30, RTX40, RTX45, RTX50, RTX55, RTX60, RTX70

CODE	Pz	
FG 152RTX/S10	10	

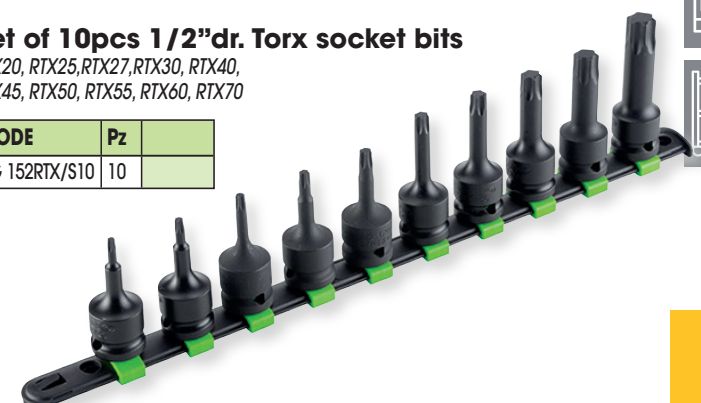



1/2"dr. reversible ratchet handle

CODE	L/mm	■	
FG 625/CR12	250	1/2"	

- Ring-shaped inversion system integrated on the head
- 72 tooth mechanism
- Mirror finish
- Hook-in slot

1/4"dr. Reversible ratchet handle - TWISTER HANDLE

CODE	L/mm	■	
FG 625/RT12	260	1/2"	

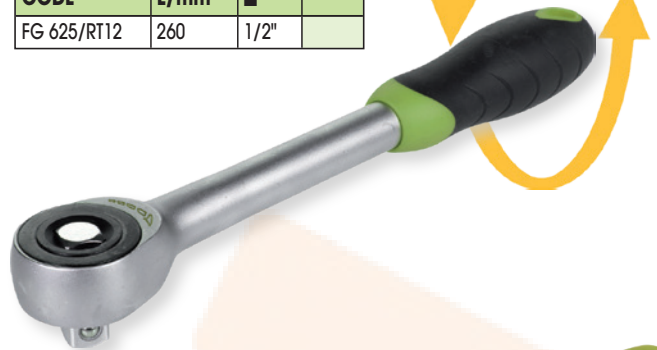

1/2"dr. swivel drive with handle

CODE	L/mm	
FG 625/CS12	246	
FG 625/CS12B	381	



1/2"dr. reversible ratchet handle

CODICE	■	
FG 625/FR12	1/2"	

NEW



- Model with closed dust-proof head
- Integrated reversing lever flush with the head
- 13 ° hollow body to allow use even in particularly difficult spaces
- 72 tooth mechanism
- Mirror finish
- Hook-in slot

1/2"dr. swivel T-Handle

CODE	L/mm	
FG 625/Q12	500	

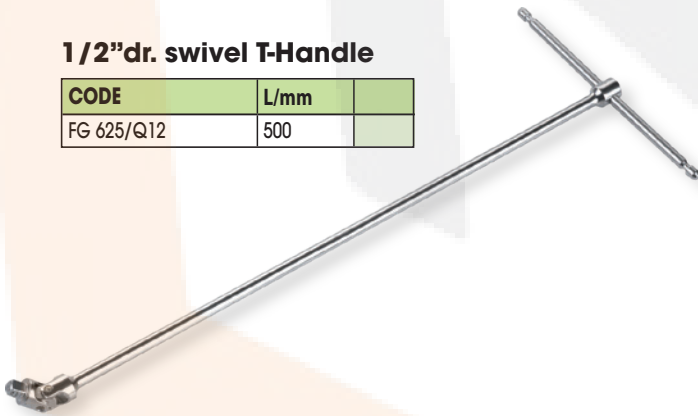

1/2" female & male drive wobble extension bar

CODE	L/mm	
FG 625/PA50	50	
FG 625/PA75	75	
FG 625/PA125	125	
FG 625/PA250	250	



1/2"dr. sliding bar

CODE	L/mm	
FG 625/ES12	305	



1/2" female and male drive extension bar

CODE	L/mm	
FG 625/PR50	50	
FG 625/PR75	75	
FG 625/PR125	125	
FG 625/PR250	250	



1/2"dr. Universal joint

CODE	L/mm	
FG 625/SN12	76	







1/2"

1/4"





CODE	CONTENT
FG 625/S70	70PZ

-  **FG 625/C8,10,11,12,13,14,15,16,17,18, 19,20,21,22,23,24,25,27,30,32**

-  **FG 624/E4,5,6,7,8,9,10,11,12,13,14**

-  **FG 624/CR14**
FG 625/CR12

-  **FG 625/SN12**
FG 624/SN14

-  **FG 625/ES12**
FG 624/ES14

-  **FG 624/GR14C**

-  **FG 625/PA125, 250**
FG 624/PA50, 100

-  **FG 89/38PI1 1/4"x1/4"**

-  **FG 85/25F1,F3,F4,F5,F7**
FG 85/25PH0, PH1, PH2
FG 85/25H2-H10
FG 85/25TX10-TX40
FG 85/25M4-M10





1/2"

-  **FG 625/C8,10,11,12,13,14,15,16,17,18, 19,22,24,27,30,32**

-  **FG 625/CR12**

-  **FG 625/SN12**

-  **FG 625/ES12**

-  **FG 624/GR14C**

-  **FG 624/PA125**

-  **FG 85/25F1,F2,F3,F4,F5,F6,F7**
FG 85/25PH0, PH1, PH2, PH3
FG 85/25H2-H10
FG 85/25TX9-TX50
FG 85/25M4-M10

-  **FG 600/B8,10,11,12,13,14,15,17,19**

-  **FG 139**

CODE	CONTENT
FG 625/S64	64pz



SOCKET SET



1/2"



FG 625/A8,9,10,11,12,13,14,15,16,17, 18,19,20,21,22,23,24,25,26,27,30,32



FG 625/CR12



FG 625/SN12



FG 625/ES12



FG 625/PA125, 250

Set of 27pcs 1/2"dr. tools

CODE	CONTENT	
FG 625/S27	27pz	

Set of 74pcs 1/4" and 1/2"dr. tools

CODE	CONTENT	
FG 625/S74	74pz	



1/4" 1/2"



FG 625/A8,9,10,11,12,13,14,15,16,17, 18,19,20,21,22,23,24,25,26,27,30,32



FG 624/E4,5,6,7,8,9,10,11,12,13,14



FG 624/CR14
FG 625/CR12



FG 625/SN12
FG 624/SN14



FG 625/ES12
FG 624/ES14



FG 624/GR14C



FG 625/PA125
FG 624/PA50, 100



FG 89/38PI1 1/4"x1/4"



FG 85/25PH1, PH2, PH3
FG 85/25SL3, SL4, SL4.5, SL5, SL5.5, SL6, L6.5
FG 85/25PZ1, PZ2, PZ3
FG 85/H1.5, H2, 2.5, H3, H4, H5, H6
FG 85/25T9, T10, T15, T20, T25, T27, T30, T40

Set of 94pcs 1/4" and 1/2"dr. tools

CODE	CONTENT	
FG 625/S94	94pz	



1/4" 1/2"



FG 625/A8,9,10,11,12,13,14,15,16,17, 18,19,20,21,22,23,24,25,26,27,30,32



FG 624/E4,5,6,7,8,9,10,11,12,13,14



FG 625L/A10,13,14,15,17,19



FG 624E/L4,5,6,7,8,9,10,11,12,13,14



FG 624/CR14
FG 625/CR12



FG 625/SN12
FG 624/SN14



FG 625/ES12
FG 624/ES14



FG 624/GR14C



FG 625/PA125, 250
FG 624/PA50, 100



FG 89/38PI1 1/4"x1/4"



FG 85/25PH1, PH2, PH3
FG 85/25SL3, SL4, SL4.5, SL5, SL5.5, SL6, L6.5
FG 85/25PZ1, PZ2, PZ3
FG 85/H1.5, H2, 2.5, H3, H4, H5, H6
FG 85/25T9, T10, T15, T20, T25, T27, T30, T40
FG 88/60PI2



Set of 109pcs 1/4" and 1/2"dr. tools

CODE	CONTENT	
FG 625/S109	109pz	



1/4" 1/2"

-  FG 625/A8,9,10,11,12,13,14,15,16,17,18,19,20,21,22,23,24,25,26,27,30,32
-  FG 624/E4,5,6,7,8,9,10,11,12,13,14
-  FG 624E/L4,5,6,7,8,9,10,11,12,13,14
-  FG 147/H2.5,3,4,5,6,7,8,10
-  FG 147/TX9,10,15,20,25,27,30,40
-  FG 624/CR14
FG 625/CR12
-  FG 625/SN12
FG 624/SN14
-  FG 625/ES12
FG 624/ES14
-  FG 624/GR14C
-  FG 625/PA125, 250
FG 624/PA50
-  FG 89/38PI1 1/4"x1/4"
-  FG 92/P
-  FG 600/B8,10,13,15,17,19
-  FG 85/25PH1, PH2, PH3, PZ1, PZ2, PZ3
FG 85/25SL3, SL4, SL4.5, SL5, SL5.5, SL6, L6.5
85/H1.5, H2, 2.5, H3, H4, H5, H6
FG 85/25TX9 - TX40, FG 88/60PI2

Set of 102pcs 1/4", 3/8" and 1/2"dr. tools

CODE	CONTENT	
FG 625/S102	102pz	



1/4" 3/8"
1/2"

-  FG 625/A8,9,10,11,12,13,14,15,16,17,18,19,20,21,22,23,24,25,26,27,30,32
-  FG 624/E4,5,6,7,8,9,10,11,12,13,14
-  FG 624/B8,9,10,11,12,13,14,15,16,17,18,19,21,22,23
-  FG 624/CR14, FG 624/CR38, FG 625/CR12
-  FG 625/SN14, FG 624/SN38, FG 624/SN12
-  FG 625/ES14, FG 624/ES38, FG 624/ES12
-  FG 625/PA125, 250
FG 624/PA100, FG 624B/PR125
-  FG 88/P14
-  FG 600/B8,10,13,15,17,19
-  FG 85/25PH1, PH2, PH3
FG 85/25SL3, SL4, SL4.5, SL5, SL5.5, SL6, L6.5
FG 85/25PZ1, PZ2, PZ3
FG 85/H1.5, H2, 2.5, H3, H4, H5, H6
FG 85/25T9, T10, T15, T20, T25, T27, T30, T40
FG 88/60PI2
-  FG TOP 620/A10, 13, 17



Set of 110pcs 1/4" and 1/2"dr. tools

CODE	CONTENT	
FG 625/S110	110pz	

1/4" 1/2"



FG 625/A8,9,10,11,12,13,14,15,16,17, 18,19,20,21,22,23,24,25,26,27,30,32



FG 624/E4,5,6,7,8,9,10,11,12,13,14



FG 624/CR14
FG 625/CR12



FG 625/SN12
FG 624/SN14



FG 625/ES12
FG 624/ES14



FG 624/GR14C



FG 625/PA125, 250
FG 624/PA50, 100



FG 89/38PI1 1/4"x1/4"

FG 85/25PH1, PH2, PH3
FG 85/25SL3, SL4, SL4.5, SL5, SL5.5, SL6, L6.5
FG 85/25PZ1, PZ2, PZ3
FG 85/H1.5, H2, 2.5, H3, H4, H5, H6
FG 85/25T9, T10, T15, T20, T25, T27, T30, T40
FG 88/60PI2



FG 139/B



FG 48/L



FG 49



FG 600/B8,10,11,12, 13,14,15,17,19



FG 22/3x75, 4x100, 5.5x100
FG 22/PH0x60, PH1x80, PH2x100



FG 59SR/160
FG 63SR/160



FG 58/B240



FG 132/H500



FG 79/SP



FG 92/P



FG 44/MT5

3/4"dr. HEX SOCKET WRENCH

→ USE

hex bolts

→ FINISH

mirror

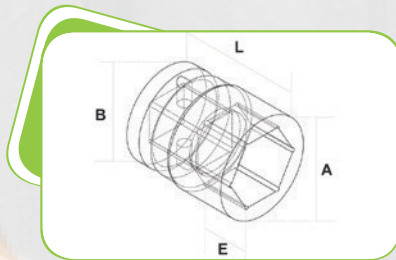

CODE	mm	A/mm	B/mm	E/mm	L/mm
FG 629/A19	19	33.0	29.2	14.0	50.0
FG 629/A22	22	36.0	32.2	14.0	50.0
FG 629/A23	23	36.0	33.2	14.0	50.0
FG 629/A24	24	36.0	33.2	14.0	50.0
FG 629/A26	26	36.0	37.0	22.0	52.0
FG 629/A27	27	36.0	38.0	22.0	52.0
FG 629/A28	28	36.0	39.0	22.0	52.0
FG 629/A29	29	38.0	40.0	22.0	52.0
FG 629/A30	30	38.0	42.0	24.0	54.0
FG 629/A32	32	38.0	44.0	26.0	56.0

CODE	mm	A/mm	B/mm	E/mm	L/mm
FG 629/A33	33	38.0	46.0	26.0	56.0
FG 629/A34	34	38.0	47.0	26.0	56.0
FG 629/A35	35	42.0	48.0	26.0	58.0
FG 629/A36	36	42.0	50.0	28.0	58.0
FG 629/A38	38	45.0	52.0	28.0	60.0
FG 629/A41	41	45.0	56.0	30.0	64.0
FG 629/A46	46	48.0	62.0	34.0	68.0
FG 629/A50	50	48.0	68.0	36.0	72.0
FG 629/A55	55	48.0	74.0	40.0	76.0
FG 629/A60	60	48.0	80.0	42.0	78.0

3/4"dr. 12PT SOCKET WRENCH

→ USE

hex and
12PT bolts

→ FINISH

mirror

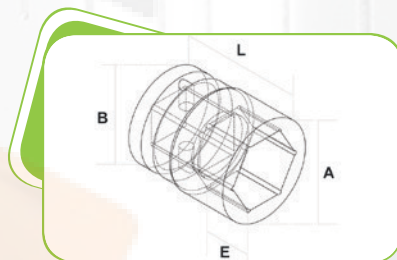

CODE	mm	A/mm	B/mm	E/mm	L/mm
FG 629/B19	19	33.0	29.2	14.0	50.0
FG 629/B22	22	36.0	32.2	14.0	50.0
FG 629/B23	23	36.0	33.2	14.0	50.0
FG 629/B24	24	36.0	33.2	14.0	50.0
FG 629/B26	26	36.0	37.0	22.0	52.0
FG 629/B27	27	36.0	38.0	22.0	52.0
FG 629/B28	28	36.0	39.0	22.0	52.0
FG 629/B29	29	38.0	40.0	22.0	52.0
FG 629/B30	30	38.0	42.0	24.0	54.0
FG 629/B32	32	38.0	44.0	26.0	56.0

CODE	mm	A/mm	B/mm	E/mm	L/mm
FG 629/B33	33	38.0	46.0	26.0	56.0
FG 629/B34	34	38.0	47.0	26.0	56.0
FG 629/B35	35	42.0	48.0	26.0	58.0
FG 629/B36	36	42.0	50.0	28.0	58.0
FG 629/B38	38	45.0	52.0	28.0	60.0
FG 629/B41	41	45.0	56.0	30.0	64.0
FG 629/B46	46	48.0	62.0	34.0	68.0
FG 629/B50	50	48.0	68.0	36.0	72.0
FG 629/B55	55	48.0	74.0	40.0	76.0
FG 629/B60	60	48.0	80.0	42.0	78.0



Set of 3/4"dr. sockets -6PT

CODE	CONTENT	
FG 629A/S10	10pz	

Set of 3/4"dr. sockets -12PT

CODE	CONTENT	
FG 629B/S10	10pz	

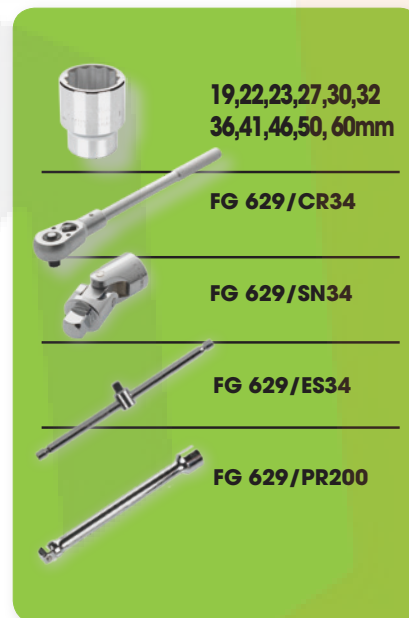
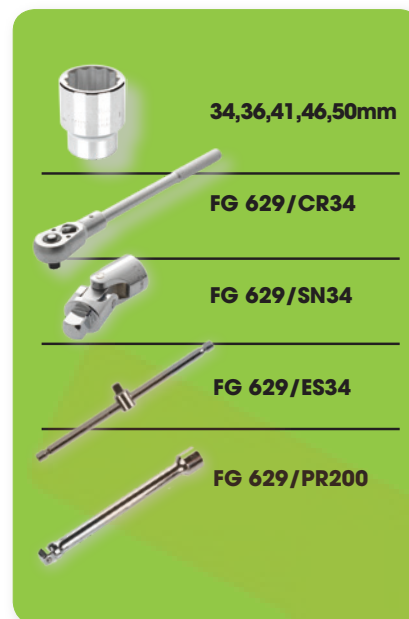

Set of 3/4"dr. sockets -6PT

CODE	CONTENT	
FG 629A/S15	15pz	

Set of 3/4"dr. sockets -12PT

CODE	CONTENT	
FG 629B/S15	15pz	



Form of 3/4"dr. sockets -6PT

CODE	CONTENT	
FG 100/25	10pz	

Form of 3/4"dr. sockets -12PT

CODE	CONTENT	
FG 100/25B	10pz	

Form of 3/4"dr. sockets -6PT

CODE	CONTENT	
FG 102/25	10pz	

Form of 3/4"dr. sockets -12PT

CODE	CONTENT	
FG 102/25B	10pz	

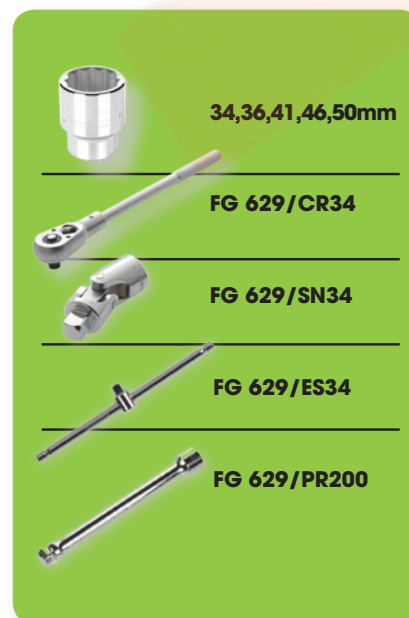



3/4"dr. reversible ratchet handle

CODE	■	L/mm	
FG 629/CR34	3/4"	500	

FG 629/CR34R Ratchet parts



3/4"dr. male and female drive extension bar

CODE	L/mm	
FG 629/PR200	200	
FG 629/PR400	400	



3/4"dr. extension bar - L type

CODE	L/mm	
FG 629/PRL	455	

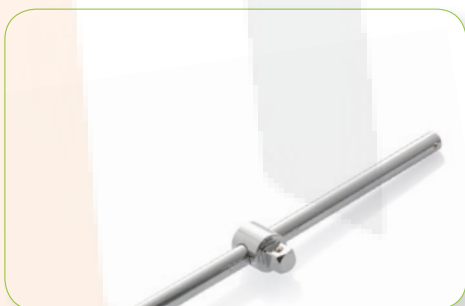

3/4"dr. sliding bar

CODE	L/mm	
FG 629/ES34	405	



3/4"dr. swivel handle

CODE	L/mm	
FG 629/QS34	500	



3/4"dr. universal joint

CODE	L/mm	
FG 629/SN34	105	

3/8"dr. impact socket wrenches

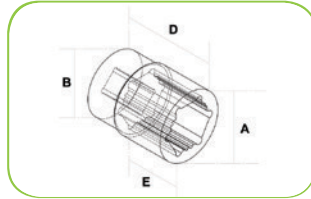

CODE	mm	A/mm	B/mm	D/mm	E/mm
FG 627/C8	8	13,0	17,7	30,0	10,9
FG 627/C9	9	14,3	17,8	30,0	11,5
FG 627/C10	10	15,5	17,8	30,0	11,7
FG 627/C11	11	16,7	17,8	30,0	11,8
FG 627/C12	10	17,8	17,8	30,0	11,5
FG 627/C13	13	19,8	19,8	30,0	11,5
FG 627/C14	14	21,9	21,9	30,0	16,4
FG 627/C15	15	23,9	23,9	30,0	16,5
FG 627/C16	16	23,9	23,9	30,0	16,5
FG 627/C17	17	25,8	25,8	30,0	16,5
FG 627/C18	18	27,9	27,9	30,0	16,5
FG 627/C19	19	27,8	27,9	30,0	16,5
FG 627/C20	20	29,8	29,8	30,0	16,5
FG 627/C21	21	29,8	29,9	30,0	17,0
FG 627/C22	22	31,9	31,9	30,0	17,0



Set of 15pcs 3/8"dr. impact socket wrenches

CODE	Pc	CONTENT
FG 627/S15B	15	8,9,10, 11, 12, 13, 14, 15, 16, 17, 18, 19, 20, 21, 22mm

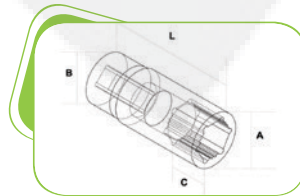
1/2"dr. impact socket
- long series

CODE	mm	A/mm	B/mm	C/mm	L/mm
FG 628/L10	10	17.5	25	13	80
FG 628/L11	11	19.0	25	13	80
FG 628/L12	12	20.0	25	13	80
FG 628/L13	13	21.0	25	13	80
FG 628/L14	14	23.0	25	13	80
FG 628/L15	15	24.0	25	13	80
FG 628/L16	16	25.0	25	13	80
FG 628/L17	17	26.5	30	17	80

CODE	mm	A/mm	B/mm	C/mm	L/mm
FG 628/L18	18	28.0	30	18	80
FG 628/L19	19	29.0	30	19	80
FG 628/L21	21	32.0	30	21	80
FG 628/L22	22	33.0	30	22	80
FG 628/L23	23	34.0	30	23	80
FG 628/L24	24	35.0	30	24	80
FG 628/L25	25	36.5	30	25	80
FG 628/L27	27	39.0	30	27	80
FG 628/L29	29	42.5	30	30	80
FG 628/L30	30	43.5	30	30	80
FG 628/L32	32	44.5	30	32	80



Set of 19pcs 1/2"dr. deep impact sockets

CODE	Pc	CONTENT
FG 628/LS19	19	10, 11, 12, 13, 14, 15, 16, 17, 18, 19, 21, 22, 23, 24, 25, 27, 29, 30, 32 mm

1/2"dr. impact socket wrenches

CODE	mm	A/mm	B/mm	D/mm	E/mm
FG 628/C10	10	15.6	22.6	38.1	7.1
FG 628/C11	11	17.8	22.6	38.1	8.4
FG 628/C12	12	18.2	24.3	38.1	9.7
FG 628/C13	13	19.3	24.3	38.1	9.7
FG 628/C14	14	22.0	24.3	38.1	10.7
FG 628/C15	15	23.2	26.6	38.1	10.7
FG 628/C16	16	24.3	26.6	38.1	11.9
FG 628/C17	17	25.4	26.6	38.1	12.7
FG 628/C18	18	26.6	26.6	38.1	12.7
FG 628/C19	19	28.3	28.3	38.1	12.7
FG 628/C20	20	29.9	29.9	38.1	14.2
FG 628/C21	21	31.5	31.5	38.1	14.2
FG 628/C22	22	33.1	33.3	38.1	14.2

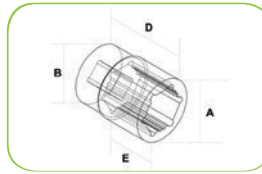

CODE	mm	A/mm	B/mm	D/mm	E/mm
FG 628/C23	23	34.0	34.0	44.5	16.3
FG 628/C24	24	34.8	34.8	44.5	16.3
FG 628/C25	25	36.4	36.4	44.5	19.6
FG 628/C26	26	37.8	37.8	50.8	19.8
FG 628/C27	27	39.4	39.4	50.8	20.3
FG 628/C30	30	43.5	41.5	51.5	21.4
FG 628/C32	32	44.5	41.5	51.5	21.8

Set of 10pcs 1/2"dr. impact socket wrenches

CODE	Pc	CONTENT
FG 628/S10	10	10, 11, 12, 13, 15, 16, 17, 18, 19, 21 mm



Set of 20pcs 1/2"dr. impact socket wrenches

CODE	Pc	CONTENT
FG 628/S20	20	10, 11, 12, 13, 14, 15, 16, 17, 18, 19, 20, 21, 22, 23, 24, 25, 26, 27, 30, 32mm

1/2"dr. impact Torx socket wrenches

CODE	E	A/mm	B/mm	D/mm	E/mm
FG 628/TX8	8	13.0	21.8	38.0	14.0
FG 628/TX10	10	14.0	21.8	38.0	14.0
FG 628/TX12	12	15.0	21.8	38.0	14.0
FG 628/TX14	14	17.0	21.8	38.0	14.0
FG 628/TX16	16	18.0	21.8	38.0	14.0
FG 628/TX18	18	20.0	21.8	38.0	14.0
FG 628/TX20	20	24.0	21.8	38.0	14.0
FG 628/TX22	22	25.8	24.0	38.0	14.0
FG 628/TX24	24	27.8	26.0	38.0	14.0

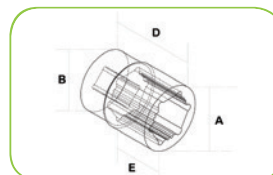

Set of 9pcs 1/2"dr. TORX impact wrenches on plastic rails

CODE	Pc	CONTENT
FG 628/TXS9	9	E8, E10, E12, E14, E16, E18, E20, E22, E24



1/2"dr. impact Torx socket wrenches

CODE	E	A/mm	B/mm	C/mm	L/mm
FG 628L/TX10	10	13.2	25.0	9.5	70.0
FG 628L/TX12	12	13.6	25.0	10.5	70.0
FG 628L/TX14	14	16.4	25.0	12.7	70.0
FG 628L/TX16	16	19.0	25.0	14.0	70.0
FG 628L/TX18	18	21.4	25.0	15.0	70.0
FG 628L/TX20	20	23.5	25.0	17.5	70.0
FG 628L/TX22	22	26.0	25.0	20.0	70.0
FG 628L/TX24	24	28.0	25.0	23.4	70.0

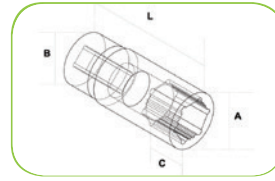

Set of 8pcs 1/2"dr. TORX impact wrenches on plastic rails

CODE	Pz	CONTENT
FG 628L/TXS8	8	E10, E12, E14, E16, E18, E20, E22, E24



1/2"dr. impact socket wrenches

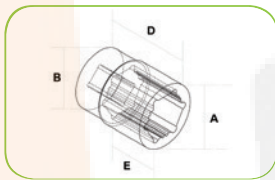

EXTRA FLAT



CODE	mm	A/mm	B/mm	D/mm	E/mm
FG 628/D10	10	17.0	23.8	28.0	7.0
FG 628/D11	11	18.0	23.9	28.0	5.5
FG 628/D12	12	19.0	23.9	28.0	7.0
FG 628/D13	13	19.8	24.0	28.0	8.0
FG 628/D14	14	22.0	24.0	28.0	6.5
FG 628/D15	15	24.0	24.0	28.0	7.5
FG 628/D16	16	24.0	24.0	28.0	7.0
FG 628/D17	17	26.0	26.0	28.0	8.0
FG 628/D18	18	28.0	28.0	28.0	7.0

CODE	mm	A/mm	B/mm	D/mm	E/mm
FG 628/D19	19	28.0	28.0	28.0	8.5
FG 628/D20	20	30.0	30.0	28.0	8.5
FG 628/D21	21	30.0	30.0	28.0	8.0
FG 628/D22	22	32.0	28.0	28.0	9.0
FG 628/D23	23	33.0	28.0	28.0	9.0
FG 628/D24	24	34.0	30.0	28.0	9.0
FG 628/D27	27	38.0	30.0	28.0	10.0
FG 628/D30	30	42.0	34.0	28.0	10.0
FG 628/D32	32	44.0	36.0	28.0	9.0

Set of 12pcs 1/2"dr. flat impact wrenches on plastic rails

CODE	Pz	CONTENT
FG 628/S12	12	10, 11, 12, 13, 14, 15, 16, 17, 18, 19, 20, 21 mm

Set of 6pcs 1/2"dr. flat impact wrenches on plastic rails

CODE	Pz	CONTENT
FG 628/S6	6	22, 23, 24, 27, 30, 32mm

1/2" female and male drive impact extension bar

CODE	L/mm
FG 628/PR125	125
FG 628/PR250	250
FG 628/PR380	380

Set of 3pcs 1/2" female and male drive impact extension bar

CODE	Pz	CONTENT
FG 628PR/S3	3	125, 250, 380mm

LOCKNUT SOCKET WITH INSIDE TEETH

- **USE** KM locknuts with INSIDE teeth
- **FINISH** burnished

CODE	KM	THREAD mm.	D/mm	D1/mm	Pins	Drive
FG 631/KM4	4	20x1	32.0	28.0	4	1/2"
FG 631/KM5	5	25x1.5	38.0	34.0	4	1/2"
FG 631/KM6	6	30x1.5	45.0	40.0	4	1/2"
FG 631/KM7	7	35x1.5	52.0	48.0	4	1/2"
FG 631/KM8	8	40x1.5	58.0	52.0	4	1/2"
FG 631/KM9	9	45x1.5	65.0	59.0	4	3/4"
FG 631/KM10	10	50x1.5	70.0	65.0	4	3/4"
FG 631/KM11	11	55x2	75.0	67.0	4	3/4"
FG 631/KM12	12	60x2	80.0	73.0	4	3/4"

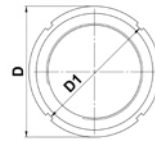

LOCKNUT SOCKET WITH OUTSIDE TEETH

- **USE** KM locknuts with INSIDE teeth
- **FINISH** burnished

CODE	KM	THREAD mm.	D/mm	D1/mm	Pins	Drive
FG 632/KM4	4	20x1	37.5	28.0	4	1/2"
FG 632/KM5	5	25x1.5	44.5	34.0	4	1/2"
FG 632/KM6	6	30x1.5	52.5	41.0	4	1/2"
FG 632/KM7	7	35x1.5	59.5	48.0	4	1/2"
FG 632/KM8	8	40x1.5	65.5	52.0	4	1/2"
FG 632/KM9	9	45x1.5	73.5	60.0	4	3/4"
FG 632/KM10	10	50x1.5	70.0	65.0	4	3/4"
FG 632/KM11	11	55x2	83.0	69.0	4	3/4"
FG 632/KM12	12	60x2	88.0	74.0	4	3/4"

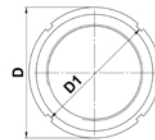
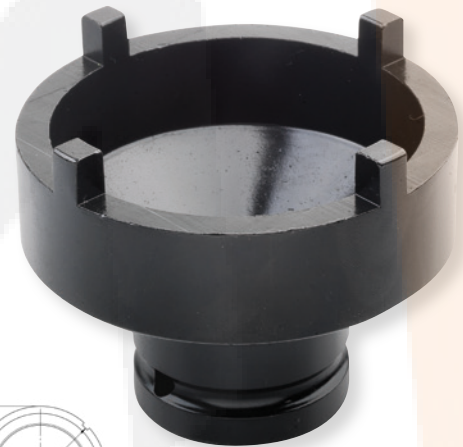

Set of 9pcs locknuts sockets with INSIDE teeth

CODE	Pz	CONTENT
FG 631/S9	9	KM4 - KM12

Set of 9pcs locknuts sockets with OUTSIDE teeth

CODE	Pz	CONTENT
FG 632/S9	9	KM4 - KM12



3/4"dr. HEX IMPACT SOCKET WRENCH

→ **USE** hex bolts

→ **FINISH** burnished

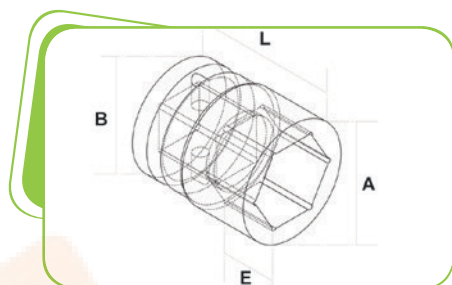

CODE	mm	A/mm	B/mm	E/mm	L/mm
FG 629/C17	17	30.0	44.0	14.0	51.0
FG 629/C18	18	31.0	44.0	14.0	51.0
FG 629/C19	19	32.5	44.0	14.0	51.0
FG 629/C21	21	35.0	44.0	14.0	51.0
FG 629/C22	22	36.0	44.0	14.0	51.0
FG 629/C23	23	37.5	44.0	14.0	51.0
FG 629/C24	24	38.5	44.0	14.0	51.0
FG 629/C27	27	42.5	44.0	20.0	53.0
FG 629/C28	28	44.0	44.0	20.0	53.0
FG 629/C30	30	46.0	44.0	20.0	53.0
FG 629/C32	32	48.5	44.0	21.0	57.0

CODE	mm	A/mm	B/mm	E/mm	L/mm
FG 629/C33	33	50.0	44.0	21.0	57.0
FG 629/C34	34	51.0	44.0	21.0	57.0
FG 629/C36	36	53.5	44.0	21.0	57.0
FG 629/C40	40	58.5	44.0	22.0	58.0
FG 629/C41	41	60.0	44.0	22.0	58.0
FG 629/C46	46	66.0	44.0	25.0	62.0
FG 629/C50	50	71.0	44.0	30.0	68.0
FG 629/C54	54	76.0	54.0	32.0	72.0
FG 629/C55	55	77.5	54.0	32.0	72.0
FG 629/C58	58	81.0	54.0	32.0	72.0
FG 629/C60	60	83.5	54.0	32.0	72.0



Set of 10pcs 3/4"dr. impact socket wrenches

CODE	Pc	CONTENT
FG 629C/S10	10	17, 19, 22, 24, 27, 30, 32, 36, 41, 46mm

3/4"dr. HEX IMPACT SOCKET WRENCH long series

→ **USE** hex bolts

→ **FINISH** burnished

CODE	mm	A/mm	B/mm	C/mm	L/mm
FG 629/L17	17	30.0	44.0	26.0	90.0
FG 629/L19	19	32.5	44.0	26.0	90.0
FG 629/L21	21	35.0	44.0	26.0	90.0
FG 629/L22	22	36.0	44.0	26.0	90.0
FG 629/L24	24	38.5	44.0	26.0	90.0
FG 629/L26	26	38.5	44.0	28.0	90.0
FG 629/L27	27	42.5	44.0	28.0	90.0
FG 629/L30	30	46.0	44.0	28.0	90.0
FG 629/L32	32	48.5	44.0	28.0	90.0
FG 629/L33	33	50.0	44.0	30.0	90.0
FG 629/L34	34	51.0	44.0	30.0	90.0
FG 629/L36	36	53.5	44.0	30.0	90.0
FG 629/L38	38	56.0	44.0	34.0	90.0
FG 629/L41	41	60.0	44.0	34.0	90.0
FG 629/L46	46	66.0	44.0	34.0	90.0
FG 629/L50	50	71.0	44.0	36.0	90.0

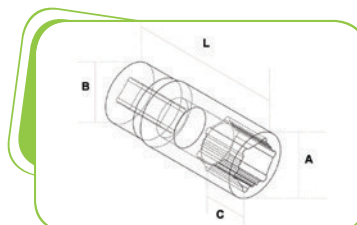

1"dr. HEX IMPACT SOCKET WRENCH

- **USE** hex bolts
- **FINISH** burnished

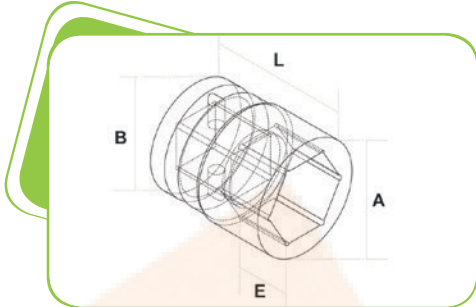

CODE	mm	A/mm	B/mm	L/mm	E/mm
FG 630/A24	24	51.0	39.9	58.0	17.0
FG 630/A27	27	51.0	43.9	58.0	17.0
FG 630/A30	30	51.0	48.0	60.0	21.0
FG 630/A32	32	51.0	51.0	60.0	21.0
FG 630/A33	33	52.0	53.0	62.0	21.0
FG 630/A34	34	52.0	53.5	62.0	21.0
FG 630/A36	36	52.0	55.0	62.0	21.0
FG 630/A38	38	52.0	57.9	62.0	26.0

CODE	mm	A/mm	B/mm	L/mm	E/mm
FG 630/A41	41	52.0	61.5	62.0	26.0
FG 630/A46	46	58.0	68.0	64.0	27.0
FG 630/A50	50	58.0	72.9	70.0	31.0
FG 630/A55	55	58.0	79.0	70.0	31.0
FG 630/A60	60	62.0	87.1	78.0	35.0
FG 630/A65	65	62.0	93.0	80.0	36.0
FG 630/A70	70	62.0	98.0	85.0	40.0
FG 630/A75	75	86.0	103.9	95.0	48.0
FG 630/A80	80	86.0	110.0	98.0	52.0



Set of 14pcs 1"dr. impact socket wrenches

CODE	Pc	CONTENT
FG 630A/S14	14	24, 27, 30, 32, 33, 34, 36, 38, 41, 46, 50, 55, 60, 65mm

1"dr. HEX IMPACT SOCKET WRENCH long series

- **USE** hex bolts
- **FINISH** burnished

CODE	mm	A/mm	B/mm	C/mm	L/mm
FG 630/L24	24	51.0	51.0	17.0	108.0
FG 630/L27	27	51.0	51.0	17.0	108.0
FG 630/L30	30	51.0	51.0	21.0	108.0
FG 630/L32	32	51.0	51.0	21.0	108.0
FG 630/L33	33	52.0	52.0	21.0	108.0
FG 630/L34	34	52.0	52.0	21.0	108.0
FG 630/L36	36	52.0	52.0	21.0	108.0
FG 630/L41	41	52.0	61.5	26.0	108.0
FG 630/L46	46	52.0	61.5	26.0	108.0
FG 630/L50	50	58.0	68.0	27.0	108.0
FG 630/L55	55	58.0	72.9	31.0	108.0
FG 630/L60	60	58.0	79.0	31.0	108.0
FG 630/L65	65	62.0	87.1	35.0	108.0
FG 630/L70	70	62.0	93.0	36.0	108.0

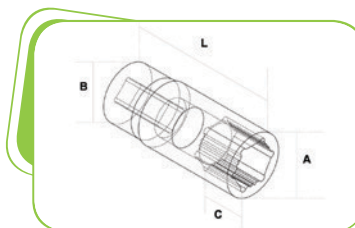



Hand adaptor

1/4"

CODE	□	■	L/mm	
FG 624/AD1	1/4"	3/8"	28	



Hand adaptor

3/8"

CODE	□	■	L/mm	
FG 624/AD2	3/8"	1/4"	30	
FG 624/AD3	3/8"	1/2"	30	



Hand adaptor

1/2"

CODE	□	■	L/mm	
FG 625/AD1	1/2"	1/4"	28	
FG 625/AD2	1/2"	3/8"	30	
FG 625/AD3	1/2"	3/4"	28	



Hand adaptor

3/4"

CODE	□	■	L/mm	
FG 629/AD3	3/4"	1/2"	30	

Set of 7pcs hand adaptors
+ 3pcs universal joints

CODE	CONTENT □ x ■	
FG 625AD/S10	1/4"x3/8", 3/8"x1/4", 3/8"x1/2", 1/2"x1/4", 1/2"x3/8", 1/2"x3/4", 3/4"x1/2"	

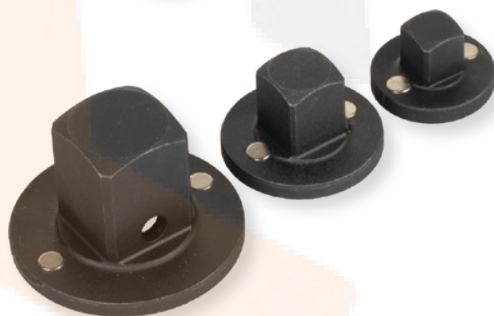

Magnetic hand adaptor - SUPER FLAT

CODE	□	■	L/mm	
FG 624/AM1	1/4"	3/8"	13.6	
FG 624/AM2	3/8"	1/2"	18.4	
FG 625/AM3	1/2"	3/4"	27.5	



Set of 3pcs magnetic hand adaptor - SUPER FLAT

CODE	CONTENT □ x ■	
FG 625AM/S3	1/4"x3/8", 3/8"x1/2", 1/2"x3/4"	



Impact adaptor

CODE	□	■	L/mm	
FG 624/AD4	1/4"	3/8"	28	

1/4"

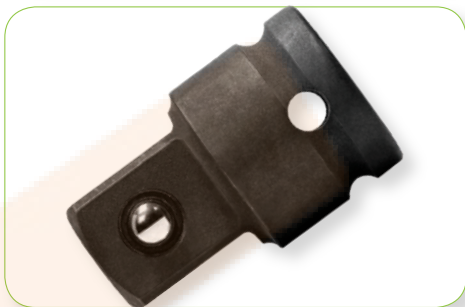

Impact adaptor

CODE	□	■	L/mm	
FG 624/AD5	3/8"	1/2"	30	

3/8"



Impact adaptor

CODE	□	■	L/mm	
FG 628/AD1	1/2"	1/4"	28	
FG 628/AD2	1/2"	3/8"	30	
FG 628/AD3	1/2"	3/4"	28	

1/2"



Impact adaptor

CODE	□	■	L/mm	
FG 629/AD1	3/4"	1/2"	30	
FG 629/AD2	3/4"	1"	28	

3/4"

CODE	SUITABLE FOR:	
FG TOP 509R/AS1	Plug + ring 3/4"	



Impact adaptor

CODE	□	■	L/mm	
FG 630/AD1	1"	3/4"	30	

1"

CODE	SUITABLE FOR:	
FG 630/AS1	Coppia di spina + anello 1"	



Male and female universal joint

CODE	L/mm	
FG 625/SN12R	105	
FG 629/SN34R	105	

1/2"

3/4"

